

# MODEL : INF-5503UHJLIPC-U

Zero Bezel with PCAP Touchscreen  
1500R J-Type Curved Monitor

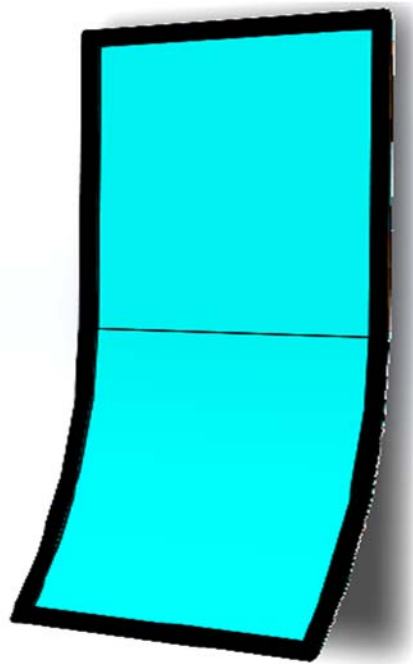

Revision	Date	History
V0.1	2022.09.01	Initial Release.

Draft \_\_\_\_\_

Date : \_\_\_\_\_

Checked: \_\_\_\_\_

Date : \_\_\_\_\_

Approved : \_\_\_\_\_

Date : \_\_\_\_\_

---

# Contents

## 1. General Description

- 1.1 Overview
- 1.2 General Specifications
- 1.3 Environmental and Reliability Specification
- 1.4 Power Supply Rating
- 1.5 Input/Output Port

## 2. User Control & OSD

- 2.1 Key Control Board
- 2.2 OSD Control Function

## 3. Connector Description

- 3.1 Summary
- 3.2 DP 2: DP (Display Port) Input Jack
- 3.3 DP 1: DP (Display Port) Input Jack
- 3.4 HDMI 2: HDMI Input Jack
- 3.5 HDMI 1: HDMI Input Jack
- 3.6 J6: 24VDC Input Jack
- 3.7 J9: 12VDC Input Jack (Optional)
- 3.8 J13: Main Power/ SMPS Power Input Connector
- 3.9 J12: Backlight Inverter Connector
- 3.10 J14: 12VDC/5VDC Power Output Connector
- 3.11 J16: Panel Power Connector
- 3.12 J8: Auto Dimming/RS232 Connector
- 3.13 CNF3: V-by-One Output Connector
- 3.14 J17: eDP Output Connector
- 3.15 J15: OSD Board Connector

## 4. Standard Display Modes

## 5. LED Backlight Driver Board Specification

## 6. Board Dimensions

## 7. Touchscreen Specification

## 8. Packing Information

## 9. Mechanical Structure

# 1. General Description

## 1.1 Overview

- ◆ SUZOHAPP 1500R J-Curved LCD Monitor INF-5503UHJLIPC-U is a high performance. TFT LCD monitor providing a high quality screen image.
- ◆ This monitor supports HDMI and DP input. Other input options are available.
- ◆ Wide input resolution range up to UHD (3840 x 2160@60Hz).
- ◆ It is designed for industrial use with Auto power on, up scaling performance adequate for low-resolution applications and enhanced design margin for reliability.
- ◆ It is available in matching touch and non-touch designs.

## 1.2 General Specifications

LCD Panel	Size	55.0" Diagonal
	Active Display Area	680.4mm(H) x 1193.35mm(V)
	Type No.	IC-550JAT1-500 (With Touchscreen)
	Number of Pixels	2160 (H) x 3840 (V)
	Pixel Arrangement	RGB Vertical Stripe
	Pixel Pitch	0.315mm(H) x 0.315mm(V)
	Color Depth	8bit+FRC / 1.07B True Colors
	Surface Treatments	Anti-Glare Haze 25%, Hard –coating (3H)
	Viewing Angle (CR>10)	R/L: 178 degree (89/89) U/D: 178 degree (89/89)
	Contrast Ratio	Typ. 4000 : 1
	Response Time(Typ.)	8ms
	Average Brightness	Typ. 500 cd/m2 (With Touchscreen)
	Frame Rate	Typ. 60Hz
	Curved Type	J-Type
	Radius	1500R
Backlight Unit	LED	
Input Resolution	Prime	3840 x 2160@60Hz
	Standard	800x600@60/72/75Hz, 1024x768@60/70/75Hz, 1280x1024@60/75Hz, 1366x768@60Hz, 1600x900@60Hz, 1680x1050@60Hz, 1920x1080@60Hz, 1920x1200@60Hz 2560x 1600@60Hz, 3840x2160@60Hz

<b>Input Signal Port</b>	HDMI 2.0	19pin HDMI Jack x 2 Port
	DP(Display Port) 1.2	15pin DP Jack x 2 Port
	Power Jack	Power Mini-Din 4P x 1 Port
<b>Scanning Frequency</b>	Horizontal	30 ~130Khz
	Vertical	55 ~75Hz
<b>OSD Control</b>		Menu, Select, Up, Down, Power
<b>Plug &amp; Play</b>		VESA DDC 2B Ver1.3
<b>Touchscreen</b>	Touch Panel	P-CAP Touch : 55.0" J-Curved Touch / 10 Point (TP550FI4C-AJ)
	Controller	BTC-B1 (Touch IC : Weida)
	Controller Interface	USB 2.0 Type "B"
<b>RoHS</b>		RoHS2 Compliance
<b>Mounting Options</b>		400(H) x 400(V)mm M6 VESA Mounting Holes

**Application Caution**

- 1. Precautions for strong light exposure.**  
Strong light exposure causes degradation of polarizer and color filter.

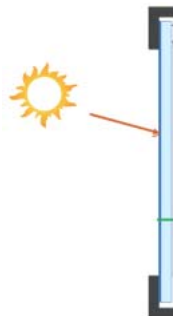

- 2. Using Conditions.**

- Temperature inside the cabinet should be controlled 'at room temp' (0 ~ 40°C) by cooler and fan.

### 1.3 Environmental and Reliability Specification

- This specification depends on the LCD panel characteristics. Please refer to the manufacturer's panel specification for details.

Item	Symbol	Min	Max	Unit
Operating Temperature	TOP	0	+50	°C
Operating Humidity	HOP	10	90	%
Storage Temperature	TST	-20	+60	°C
Storage Humidity	HST	10	90	%

### 1.4 Power Supply Rating

Optional PSU Input Voltage	AC 100 ~ 240VAC,50/60Hz
Optional PSU Output Voltage	DC 24V8.33A
Monitor DC Input Voltage	24VDC
Power Consumption	Typ. 140W (24VDC / 5.8A)

### 1.5 Input/Output Port

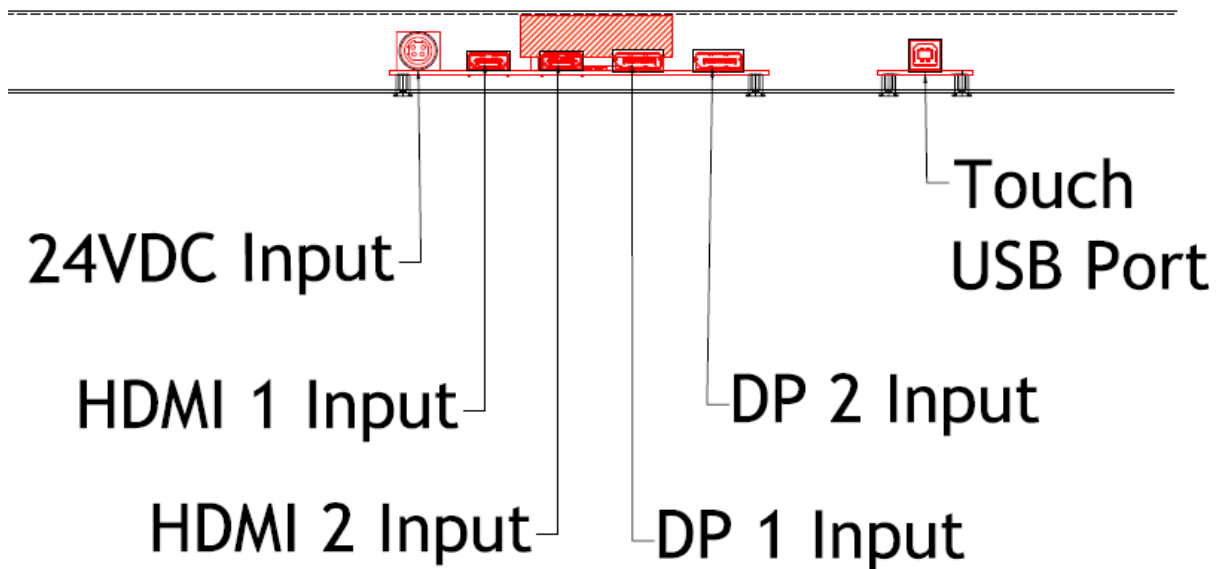

## 2. User Control & OSD

### 2.1 Key Control Board

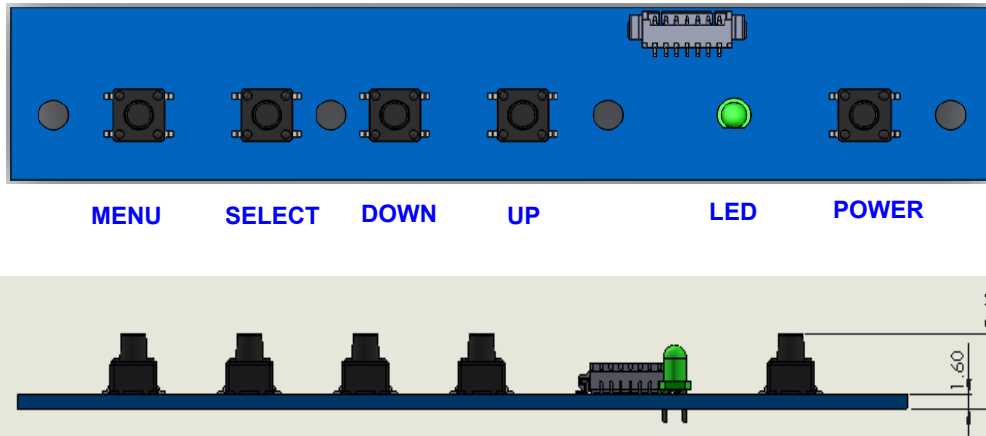
**K002**

Button	Function	Status	HOT Key
LED	Indicates operation status	Green : Normal State Red : Off Mode Green Blinking : DPMS Mode	
POWER	Power on/off		
MENU	Enable MENU Window Disable MENU Window Exit from Sub function		
SELECT	Select function		No OSD Window, Input Source Change
DOWN	Move to Down or Left		No OSD Window, Auto Color
UP	Move to Up or Right		No OSD Window, Auto Configuration

## 2.2 OSD Control Function

The chosen OSD settings will be stored in memory. The OSD menu can be cleared from the screen by pressing the **MENU** button otherwise it will be automatically cleared after a few second of non-use.

### 2.2.1 OSD Main Menu

#### 1) PICTURE

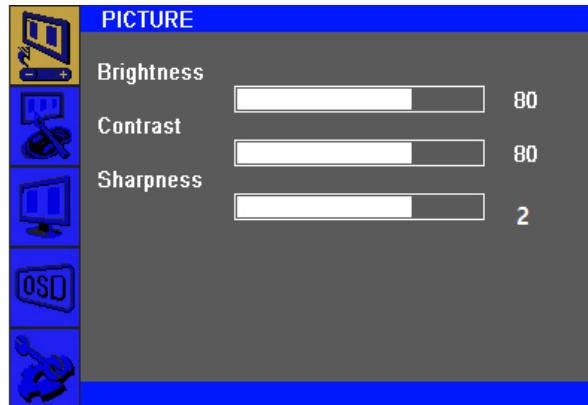

Brightness (0 ~ 100)	Increases/decreases monitor Brightness. Default: 100
Contrast (0 ~ 100)	Increases/decreases monitor Contrast. Default: 100
Sharpness (0 ~ 4)	Adjusts Sharpness of the displayed images. Default : 2

#### 2) COLOR



Color Status Management	Selects the display's color temperature. The available color settings "Normal", "Warm", "Cool", "User", "Game" mode. Default : User
Red (0 ~ 100)	Increases/decreases Red Color Temperature. Default : 50
Green (0 ~ 100)	Increases/decreases Green Color Temperature. Default : 50
Blue (0 ~ 100)	Increases/decreases Blue Color Temperature. Default : 50

3) OSD

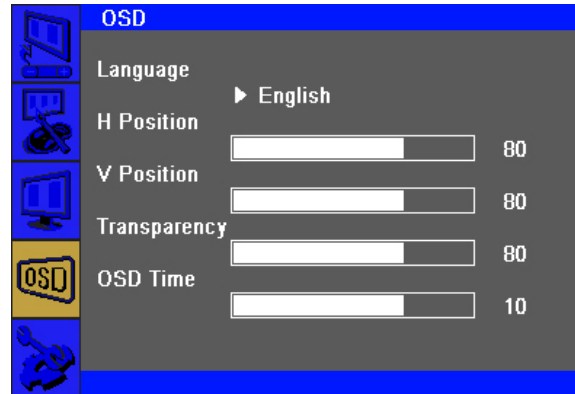

Language	Selects the OSD's display language. The available languages are English, Deutsch, Français, Italiano, Español, Korean. Default : English
H Position (0 ~ 100)	Adjusts the horizontal location of the OSD menus on the display. Default : 50
V Position (0 ~ 100)	Adjusts the vertical location of the OSD menus on the display. Default : 50
Transparency (0 ~ 100)	Adjusts the transparency of the OSD menus on the display. Default : 33
OSD Time (0 ~ 60)	Adjusts how long the touch monitor will wait without OSD button activity before closing the OSD. The adjustable range is between 0 and 60 seconds. Default : 10

4) SETUP

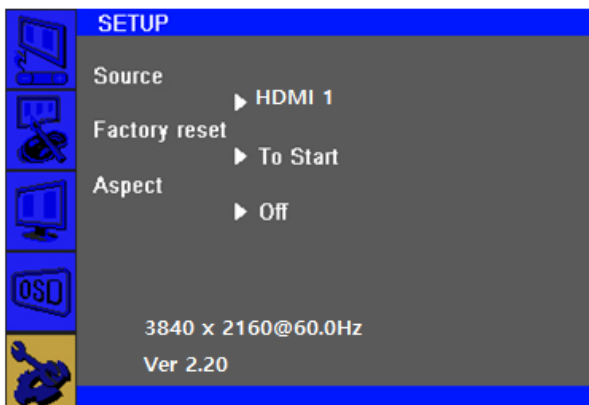

5) Input Source



Source	Selects Input Source HDMI1, HDMI2, DP1, DP2
Factory reset	Restores all factory default settings for OSD-adjustable parameters and for Preset Video Mode timings.
Aspect	Switches the scaling method between Full Scaling and Maintain Aspect Ratio. Default : Off



### 3. Connector Description

#### 3.1 Summary

Reference	Item	Description	Component	Manufacture
DP2	Jack	DP Input Jack	DP-20P	-
DP1	Jack	DP Input Jack	DP-20P	-
HDMI2	Jack	HDMI Input Jack	HDMI-19P	
HDMI1	Jack	HDMI Input Jack	HDMI-19P	
J6	Jack	24VDC Power Input Jack	KPJ-4S-S	
J9	Jack	12VDC Power Input Jack (Optional)	DJ05H-250	
J13	Wafer	Main Power / SMPS Power Input Connector	SMAW250-10	YEON-HO
J12	Wafer	Backlight Inverter Connector	SMAW250-12	YEON-HO
J14	Wafer	12VDC/5VDC External Power Output Connector	SMAW250-06	YEON-HO
J16	Wafer	Panel Power Output Connector	SMAW250-04	YEON-HO
J8	Wafer	Auto-Dimming/RS232 Connector	SMAW200-05	YEON-HO
CNF3	Wafer	V By One Output(8Lane) Connector	FI-RE51S-HF	YEON-HO
J17	Wafer	eDP Output(4Lane/8Lane) Connector	20347-040E	I-PEX
J15	Wafer	OSD Board Connector	12505WR-07	YEON-HO

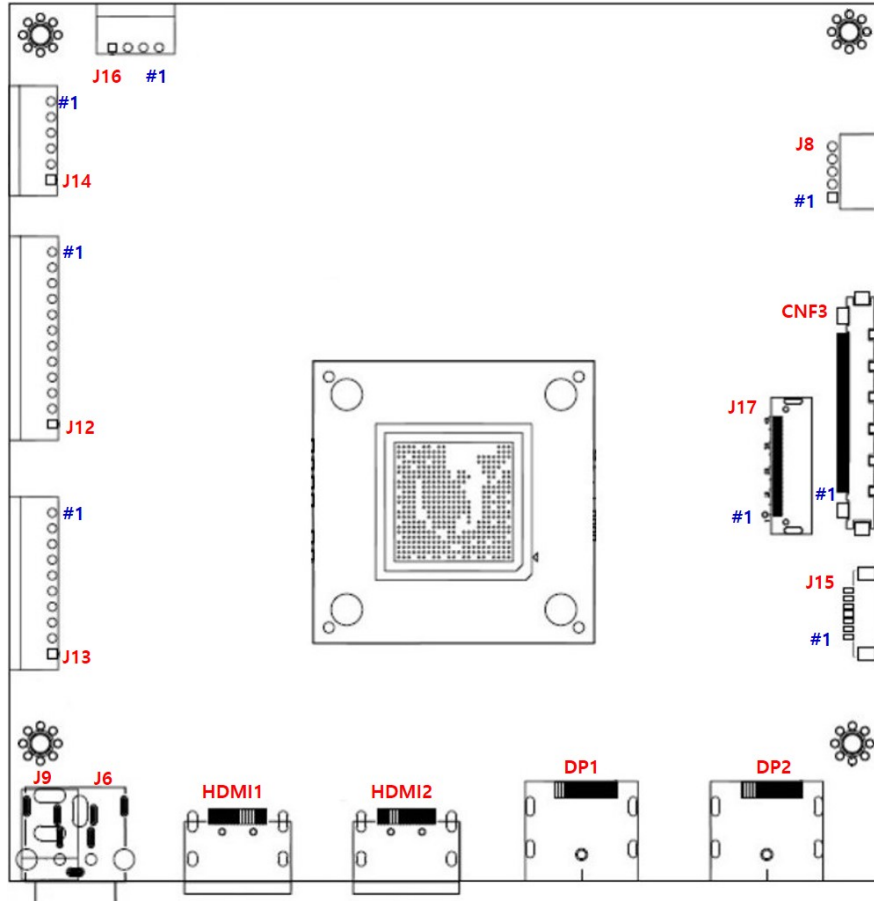

**3.2 DP2: DP 1.2 (Display Port) Input Jack**



Pin No.	Symbol	Description
1	LANE3-	Component Signal for Main Link 3
3	LANE3+	True Signal for Main Link 3
4	LANE2-	Component Signal for Main Link 2
6	LANE2+	True Signal for Main Link 2
7	LANE1-	Component Signal for Main Link 1
9	LANE1+	True Signal for Main Link 1
10	LANE0-	Component Signal for Main Link 0
12	LANE0+	True Signal for Main Link 0
13	CA DET	No Connection
14	DP DET+	No Connection
15	AUX CH+	True Signal for Auxiliary Channel
17	AUX CH-	Component Signal for Auxiliary Channel
18	+5V Power	Identify the presence of a monitor
19	RETURN	No Connection
20	PWR OUT	No Connection
16	GND	Ground

**3.3 DP1: DP 1.2 (Display Port) Input Jack**

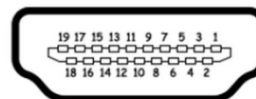

Pin No.	Symbol	Description
1	LANE3-	Component Signal for Main Link 3
3	LANE3+	True Signal for Main Link 3
4	LANE2-	Component Signal for Main Link 2
6	LANE2+	True Signal for Main Link 2
7	LANE1-	Component Signal for Main Link 1
9	LANE1+	True Signal for Main Link 1
10	LANE0-	Component Signal for Main Link 0
12	LANE0+	True Signal for Main Link 0
13	CA DET	No Connection
14	DP DET+	No Connection
15	AUX CH+	True Signal for Auxiliary Channel
17	AUX CH-	Component Signal for Auxiliary Channel
18	+5V Power	Identify the presence of a monitor
19	RETURN	No Connection
20	PWR OUT	No Connection
16	GND	Ground

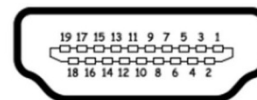
**3.4 HDMI2: HDMI 2.0 Input Jack**

Pin No.	Symbol	Description
1	TMDS DATA2+	TMDS DATA2 Differential Positive Signal
2	GND	Ground
3	TMDS DATA2-	TMDS DATA2 Differential Negative Signal
4	TMDS DATA1+	TMDS DATA1 Differential Positive Signal
5	GND	Ground
6	TMDS DATA1-	TMDS DATA1 Differential Negative Signal
7	TMDS DATA0+	TMDS DATA0 Differential Positive Signal
8	GND	Ground
9	TMDS DATA0-	TMDS DATA0 Differential Negative Signal
10	TMDS CLOCK+	TMDS CLOCK Differential Positive Signal
11	GND	Ground
12	TMDS CLOCK-	TMDS CLOCK Differential Negative Signal
13	CEC	CEC Function
14, 17	NC	No Connection
15	DDC Clock	DDC Clock Signal
16	DDC data	DDC Data Signal
18	+5V Power	+5V Power
19	HPD	Hot Plug Detection

**3.5 HDMI1: HDMI 2.0 Input Jack**

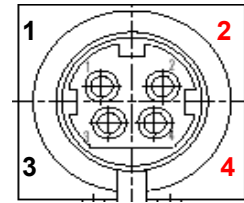
Pin No.	Symbol	Description
1	TMDS DATA2+	TMDS DATA2 Differential Positive Signal
2	GND	Ground
3	TMDS DATA2-	TMDS DATA2 Differential Negative Signal
4	TMDS DATA1+	TMDS DATA1 Differential Positive Signal
5	GND	Ground
6	TMDS DATA1-	TMDS DATA1 Differential Negative Signal
7	TMDS DATA0+	TMDS DATA0 Differential Positive Signal
8	GND	Ground
9	TMDS DATA0-	TMDS DATA0 Differential Negative Signal
10	TMDS CLOCK+	TMDS CLOCK Differential Positive Signal
11	GND	Ground
12	TMDS CLOCK-	TMDS CLOCK Differential Negative Signal
13	CEC	CEC Function
14, 17	NC	No Connection
15	DDC Clock	DDC Clock Signal
16	DDC data	DDC Data Signal
18	+5V Power	+5V Power
19	HPD	Hot Plug Detection

**3.6 J6: 24V Power Input Jack (Optional)**

Pin No.	Symbol	Description
1,3	GND	Ground
2,4	VCC	24VDC

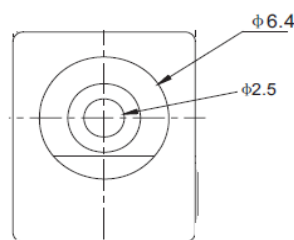
**3.7 J9 : 12V Power Input Jack (Optional)**

Pin No.	Symbol	Description
-	GND	Ground
+	VCC	12VDC

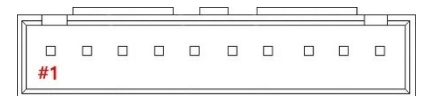
**3.8 J13: Main Power / SMPS Power Connector**

Pin No.	Symbol	Description
1, 2, 3, 4, 5	VCC	24VDC
6, 7, 8, 9,10	GND	Ground

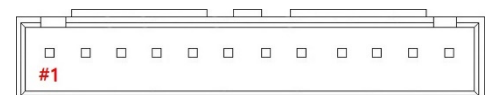
**3.9 J12: Backlight Inverter Connector**

Pin No.	Symbol	Description
1, 2, 3, 4, 5	VCC	24VDC
6, 7, 8, 9,10	GND	Ground
11	INVERTER ON/OFF	Inverter On(3.3V) / Off(0V) Signal
12	DIM-ADJUST	DIM-adjustment analog dimming control signal. * make sure inverter specification

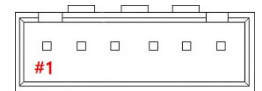
**3.10 J14: 12VDC / 5VDC External Power Output Connector**

Pin No.	Symbol	Description
1, 2, 3	+12V	12VDC Output
4	+5V	5VDC Output
5,6	GND	Ground

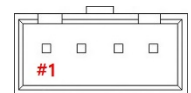
**3.11 J16: Panel Power Output Connector**

Pin No.	Symbol	Description
1, 2	PANEL_VDD	12VDC Output for Panel or FRC Power
3, 4	GND	Ground

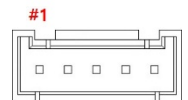
**3.12 J8: Auto-Dimming / RS232 Connector**

Pin No.	Symbol	Description
1	VCC	+5V Power for RS232
2	CDS	Light Sensor Input
3	TXD	RX232 TX
4	RXD	RX232 RX
5	GND	Ground

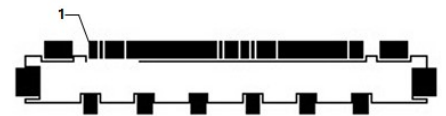
**3.13 CNF3: V By One Output (8Lane) Connector**

Pin No.	Symbol	Description
1	GND	Ground
2	VTX_TX7P	VTX_TX7P
3	VTX_TX7N	VTX_TX7N
4	GND	Ground
5	VTX_TX6P	VTX_TX6P
6	VTX_TX6N	VTX_TX6N
7	GND	Ground
8	VTX_TX5P	VTX_TX5P
9	VTX_TX5N	VTX_TX5N

10	GND	Ground
11	VTX_TX4P	VTX_TX4P
12	VTX_TX4N	VTX_TX4N
13	GND	Ground
14	VTX_TX3P	VTX_TX3P
15	VTX_TX3N	VTX_TX3N
16	GND	Ground
17	VTX_TX2P	VTX_TX2P
18	VTX_TX2N	VTX_TX2N
19	GND	Ground
20	VTX_TX1P	VTX_TX1P
21	VTX_TX1N	VTX_TX1N
22	GND	Ground
23	VTX_TX0P	VTX_TX0P
24	VTX_TX0N	VTX_TX0N
25	GND	Ground
26	VTX_PLL_Lock	VTX_PLL_Lock
27	VTX_HPD	V-by-One Hot Plug Detect
28	GND	Ground
29	V-by-one Bit Select	V-by-One 8bit/10bit Select
30	NC	LED Enable(Optional)
31	GND	No Connection
32	SDA	V-by-One IICSDA
33	SCL	V-by-One IIC SCL
34	NC	No Connection
35	AUX_CH_P2	AUX_CH_P2
36	AUX_CH_N2	AUX_CH_N2
37	GND	Ground
38	AUX_CH_P1	AUX_CH_P1
39	AUX_CH_N1	AUX_CH_N1
40, 41, 42	GND	Ground
43	NC	No Connection
44, 45, 46, 47, 48, 49, 50, 51	PANEL_VDD	12VDC Output for Panel

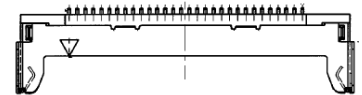
**3.14 J17: eDP Output(4Lane/8Lane) Connector**

Pin No.	Symbol	Description
1, 2, 3	PANE_VDD	12VDC Output for Panel
4	NC	No Connection
5,6,7	GND	Ground
8, 9, 10	NC	No Connection
11	eDP1_HPDP	TX HPD1
12	2 <sup>nd</sup> _AUXP	2 <sup>nd</sup> TX_AUX_P
13	2 <sup>nd</sup> _AUXN	2 <sup>nd</sup> TX_AUX_N
14	GND	Ground
15	DPTX_L7P	DPTX_L7P
16	DPTX_L7N	DPTX_L7N
17	GND	Ground
18	DPTX_L6P	DPTX_L6P
19	DPTX_L6N	DPTX_L6N
20	GND	Ground
21	DPTX_L5P	DPTX_L5P
22	DPTX_L5N	DPTX_L5N
23	GND	Ground
24	DPTX_L4P	DPTX_L4P
25	DPTX_L4N	DPTX_L4N
26	eDP0_HPDP	TX HPD0
27	1 <sup>st</sup> _AUXP	1 <sup>st</sup> TX_AUX_P
28	1 <sup>st</sup> _AUXN	1 <sup>st</sup> TX_AUX_N
29	GND	Ground
30	DPTX_L3P	DPTX_L3P
31	DPTX_L3N	DPTX_L3N
32	GND	Ground
33	DPTX_L2P	DPTX_L2P
34	DPTX_L2N	DPTX_L2N
35	GND	Ground
36	DPTX_L1P	DPTX_L1P
37	DPTX_L1N	DPTX_L1N
38	GND	Ground
39	DPTX_L0P	DPTX_L0P
40	DPTX_L0N	DPTX_L0N

**3.15 J15: OSD Controller Connector**

Pin No.	Symbol	Description
1	VCC	+5V Power for IR sensor
2	IRQ	Infrared rays signal line.
3	LED1	Green LED
4	LED2	Red LED
5	GND	Ground
6	ADC-IN0	Menu, Up
7	ADC-IN1	Power, Down, Up

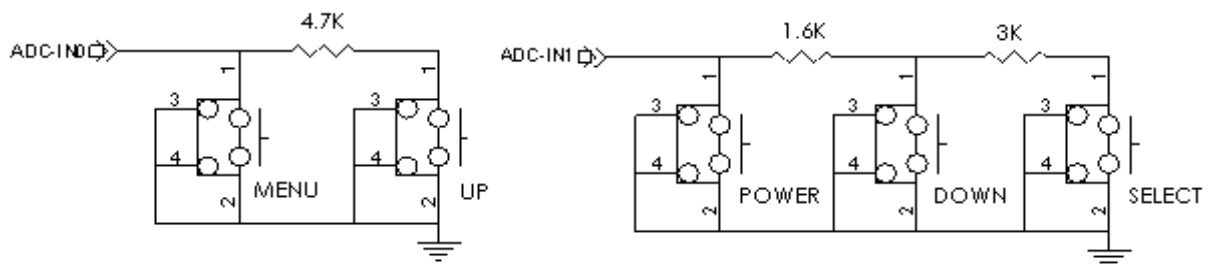



## 4. Standard Display Modes

Spec Mode	Pixel Freq. MHz	Horizontal Timing				Vertical Timing			
		Sync Polar	Freq. KHz	Total Pixel	Active Pixel	SP	Freq. Hz	Total Line	Active Lind
	720*400@70Hz	28.287	N	31.430	900	720	P	70.000	449
640*480@60Hz	28.175	N	31.469	800	640	N	59.940	525	480
640*480@72Hz	31.500	N	37.861	832	640	N	72.809	520	480
640*480@75Hz	31.500	N	37.500	840	640	N	75.000	500	480
800*600@60Hz	40.000	P	37.879	1056	800	P	60.317	628	600
800*600@72Hz	50.000	P	48.077	1040	800	P	72.188	666	600
800*600@75Hz	49.500	P	46.875	1056	800	P	75.000	625	600
1024*768@60Hz	65.000	N	48.363	1344	1024	N	60.005	806	768
1024*768@70Hz	75.000	N	56.476	1328	1024	P	70.070	806	768
1024*768@75Hz	78.750	P	60.023	1312	1024	P	75.030	800	768
1280*720@60Hz	74.500	P	44.772	1664	1280	P	59.855	748	720
1366*768@60Hz	84.75	P	47.72	1776	1366	P	59.799	798	768
1280*1024@60Hz	108.000	P	63.981	1688	1280	P	60.020	1066	1024
1280*1024@75Hz	135.000	P	79.976	1688	1280	P	75.035	1066	1024
1600*900@60Hz	97.750	P	55.540	1760	1600	N	59.948	926	900
1680*1050@60Hz	119.125	P	64.742	1840	1680	N	59.946	1080	1050
1920*1080@60Hz	138.625	P	66.647	2080	1920	N	59.988	1111	1080
1920*1200@60Hz	154.125	P	74.099	2080	1920	N	59.999	1235	1200
2560*1600@60Hz	268.500	P	98.713	2720	2560	N	60.010	1641	1600
3840*2160@60Hz	585.980	P	129.600	4480	3840		60.000	2180	2160

## 5. LED Backlight Driver Board Specification

### 5.1 Electrical Specification

Parameter		Symbol	Values			Unit	Remark	
			Min	Typ	Max			
Power Supply Input Voltage		VBL	21.6	24.0	26.4	Vdc		
Power Supply Input Current		IBL	-	-	7	A		
Power Supply Input Current (In-rush)		In-rush	-	-	10	A		
Power Consumption		PBL	-	-	152	W		
Input Voltage For Control System Signals	On/Off	On	V on	2.5	-	5.25	Vdc	HIGH : On duty LOW : Off duty
		Off	V off	-0.3	-	0.8	Vdc	
	Brightness Adjust	ExtVBR-B	10	-	100	%	On Duty	
	Pulse Duty Level (PWM)	High Level		2.5	-	5.25	Vdc	
		Low Level		0.0	-	0.7	Vdc	
		PWM Freq.		100		240	Hz	
		Duty		10	-	100	%	

### 5.2 Interface

#### 5.2.1 CN100 Connector: 20010WR-14 (YeonHo) or EQ

Pin	Symbol	Remarks
1,2,3,4,5	Vin	Input Voltage 24VDC
6,7,8,9,10	GND	GND
11	NC	No Connection
12	On/Off	Backlight On/Off (5V:On, 0V : Off)
14	PDIM	External PWM

#### 5.2.1 CN101 Connector: 20010WR-12 (YeonHo) or EQ

Pin	Symbol	Remarks
1,2,3,4,5	Vin	Input Voltage 24VDC
6,7,8,9,10	GND	GND
11	NC	No Connection
12	NC	No Connection

## 6. Board Dimensions

### 6.1 AD Board (INB3000 V2) Dimension (140mm x 140mm x 21.6mm)

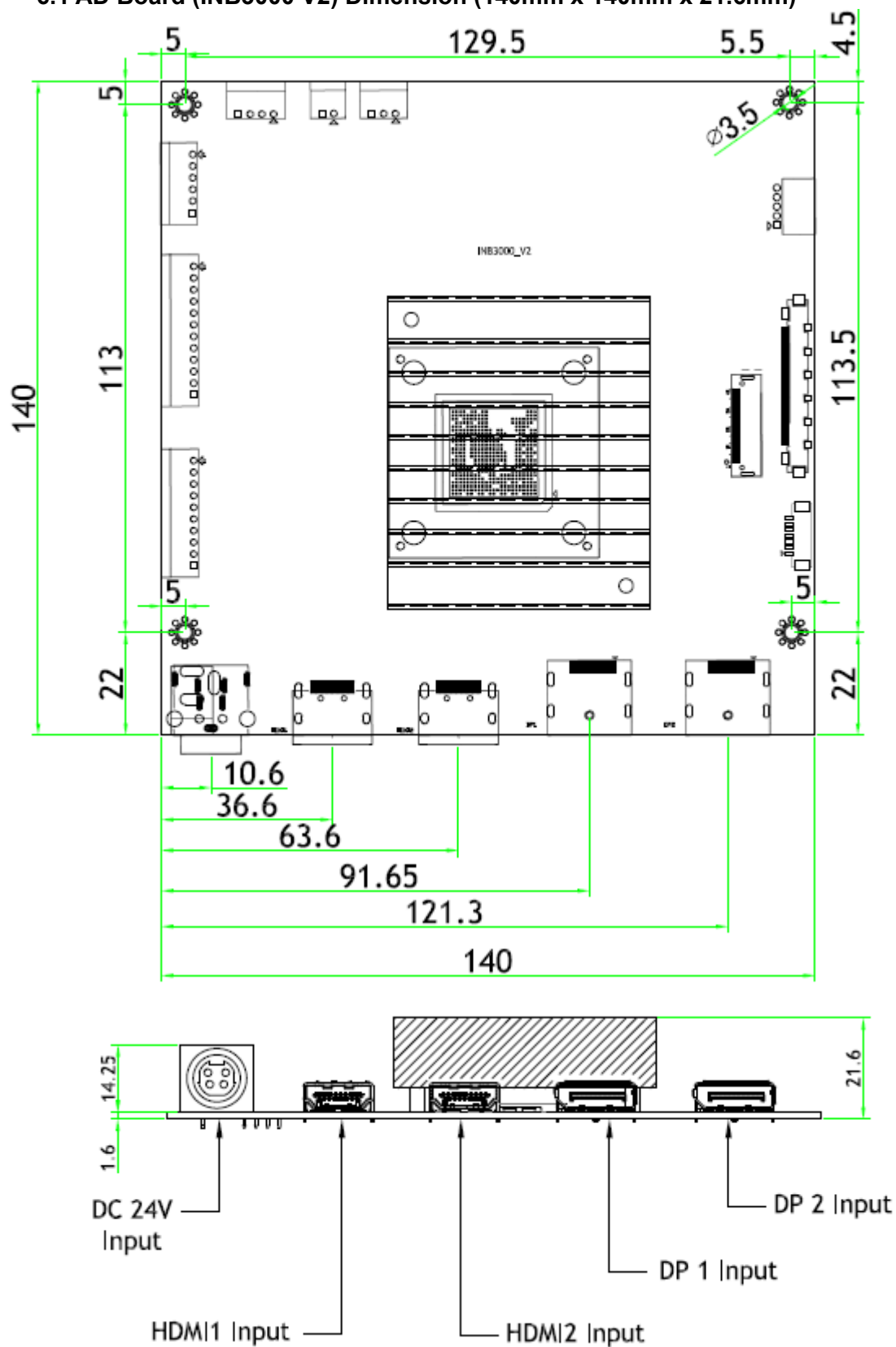

6.2 OSD Board (K002) Dimension (115mm x 20mm x 8.7mm)

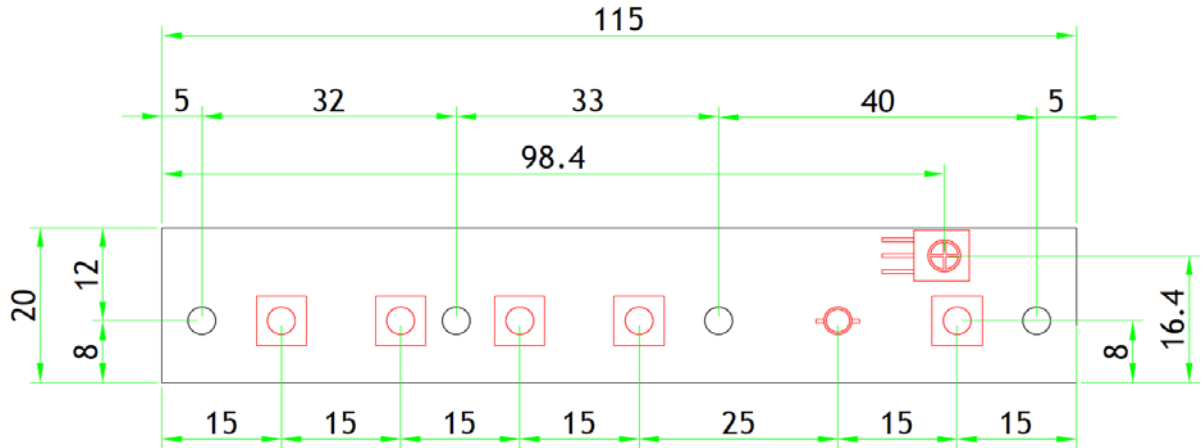

6.3 LED Driver Board (GP-1520LD) Dimension (158.0mm x 120mm x 15.0mm)

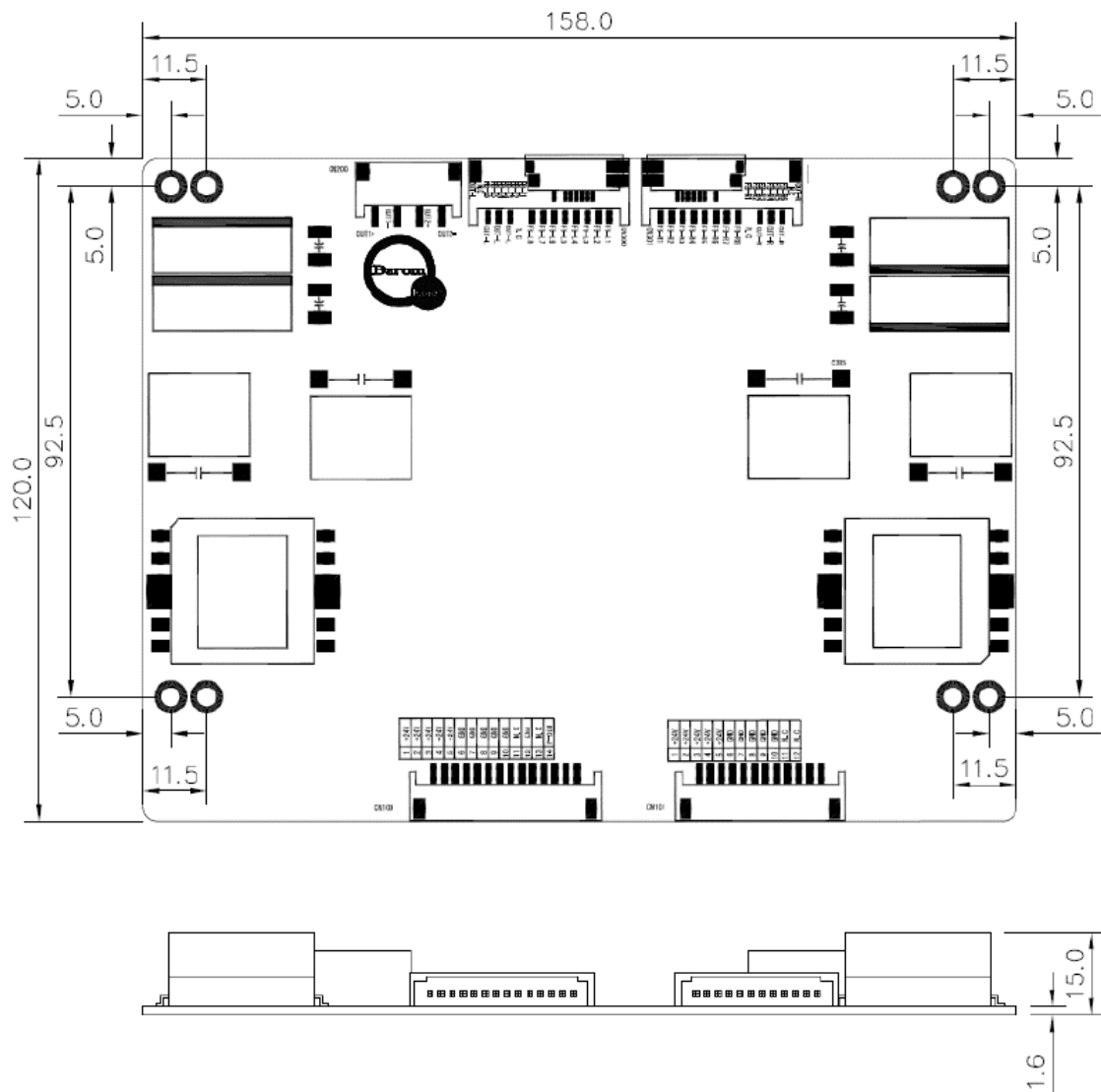

## 7. P-CAP Touchscreen Specification

### 7.1 Touch Controller Specification

Items	Description	Note
Operating Voltage	+5V	DC (Serial: External)
Response Time	<10ms	
Channels	Max.Tx:66 Rx:116 channels	Up to 65"
Interface Type	USB 2.0(VID:2575, PID:8761) - PID: Changeable	HID/Mouse Mode
	RS232(Driver: 3M MT7)	3M Compatible
Accuracy	99%	
Support Point	10 points	Serial:1-Point
Special Function	Water/Palm/Object rejection Basic(Water/Palm)	Advanced Tuning
F/W Version	TBD	
Power consumption(mA)	Active Mode: < 180mA	
Diagnostic function	Supports with LED	F-Version
Recovery function	Watchdog(P-soc)	F-Version
Operating Temperature	-20 to 80 °C	
Storage Temperature	-40 to 85 °C	

## 7.2 Features

- a. Maximum 182 Channels with Tx66 and Rx116 for Projected Capacitive Touchscreen Panel
- b. External power source(serial only): +5V(DC)
- c. OS: Windows XP/7/8/10, Android, Linux
- d. Supports High Voltage Driving & Sensing Channels
- e. The BTC-B(F-Ver) supports interface with USB and UART
- f. The BTC-B(F-Ver) supports recovery function with watchdog
- g. Advanced Water & Palm Rejection Functions Support
- h. Diagnostic Function(Intuitive diagnostic function with LED)
- i. Supports F/W Upgrade & Inspection Tool

## 7.3 Touch Control Board Dimension (130.0mm x 50.0mm)

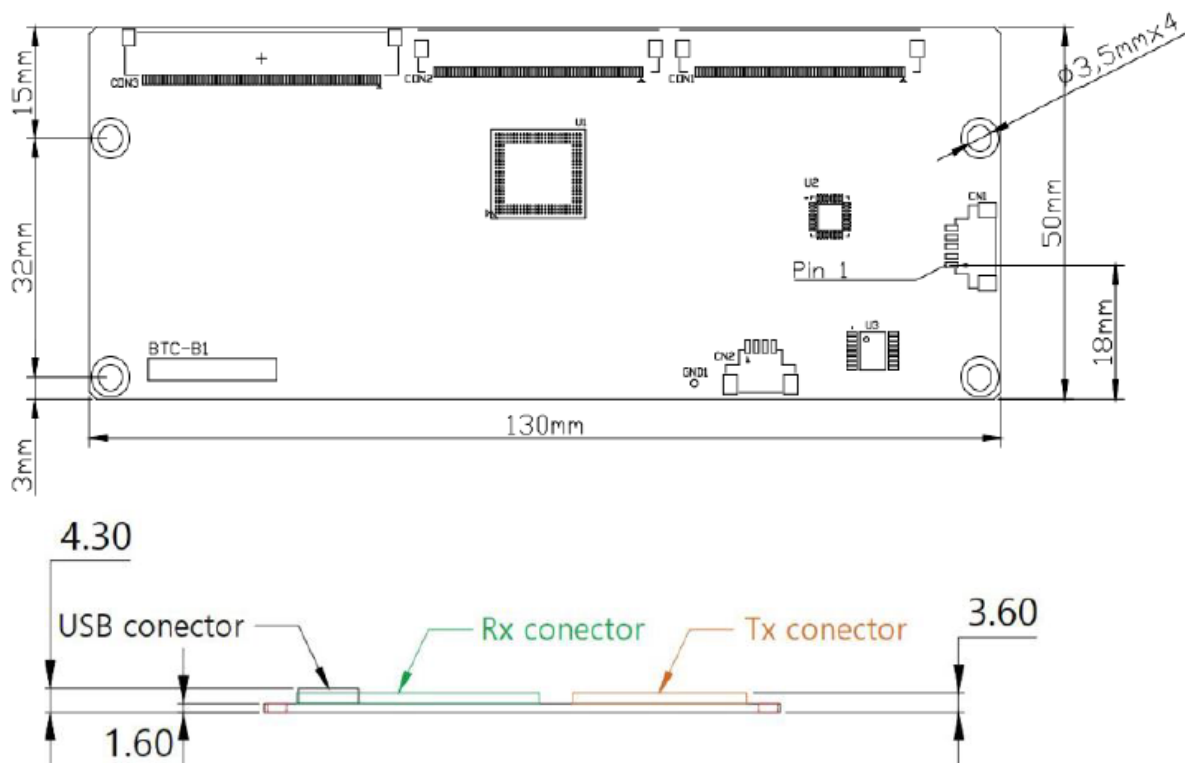

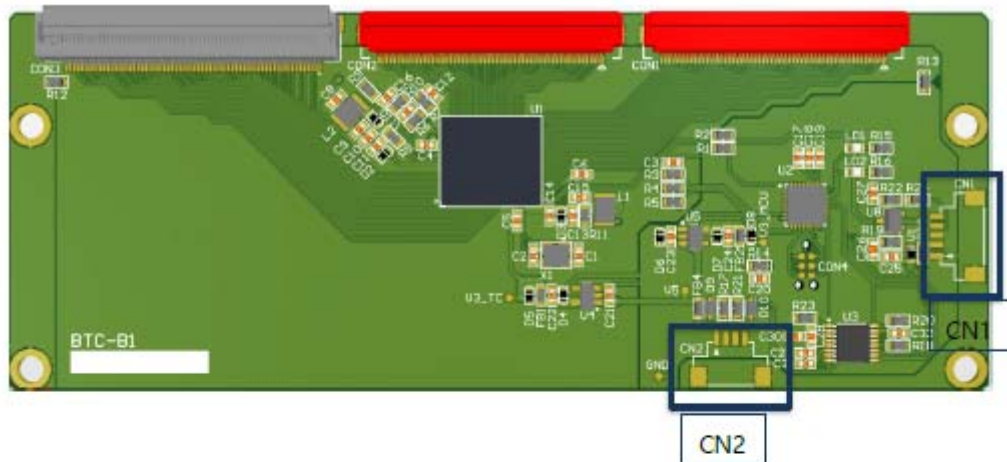
**7.3.1 Touch Controller USB Interface**

CN2 = Serial(F-Version) 12507WR 04L(YEONHO)	
PIN No.	Description
1	VDD(5V)
2	TXD
3	RXD
4	GND

CN1 = USB 12507WR-05L (YEONHO)	
PIN No.	Description
1	GND(Frame)
2	VDD(5V)
3	GND
4	D+
5	D-

**7.4. USB Connector (USB 2.0, Type “B”)**

Number	Signal Name
1	+5V
2	D-
3	D+
4	GND

**7.5 Touch Screen Dimension (751.4mm x 1260.84mm x 4.5mm)**

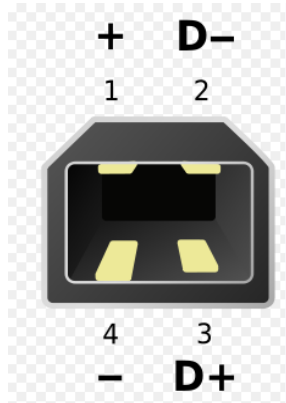
**7.6 USB Interface Port**

## 8. Packing Information

Item	Q'ty	Dimension (W x H x D)	Weight(Kg)	Remark
Open Frame	1Pcs	751.4mm x 1260.84mm x 203.43mm	TBD	
Box Packing			TBD	
Pallet Size			TBD	
Pallet Packing			TBD	

## 9. Mechanical structure