

The logo for SUZOHAPP, featuring a stylized icon of three horizontal bars on the left and the word "SUZOHAPP" in a clean, white, sans-serif font to its right.

SUZOHAPP

A man and a woman are shown in profile, looking at a large digital display. The man is pointing at the screen, and the woman is also pointing. They are both smiling. The background is a blurred office environment. The entire image has a blue color overlay.

Your Trusted Hardware Partner!

**G2E 2023**

[suzohapp.com](http://suzohapp.com)

# Who We Are

SUZOHAPP has served the gaming, amusement, and sports betting industries as a trusted hardware provider for over 60 years. SUZOHAPP is a worldwide company with operations in over 19 countries, with local contacts on each continent, local knowledge, engineering, offices, warehouses, and production sites.

We are experts in manufacturing, sourcing, specifying, and supplying hardware for the sports betting, gaming, and amusements industries with years of industry experience.

Full range of sports betting terminals and a portfolio of over 50,000 components to maximize the user experience and keep operations running smoothly.

Complete design and delivery service to help OEM's and platform developers bring new sports betting concepts to life.

Over 100 licenses for manufacturing and distribution in the states and tribal regions with more in the works.

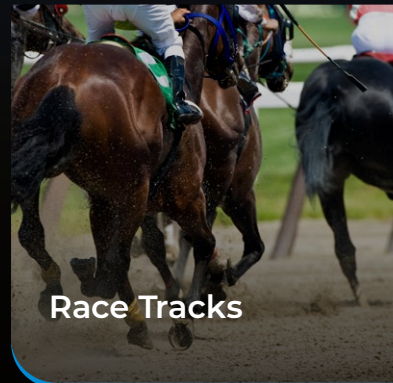



# Where We Came From

SUZOHAPP has grown rapidly to meet the needs of the markets and customers we serve, expanding the breadth of our product offering and service capability.

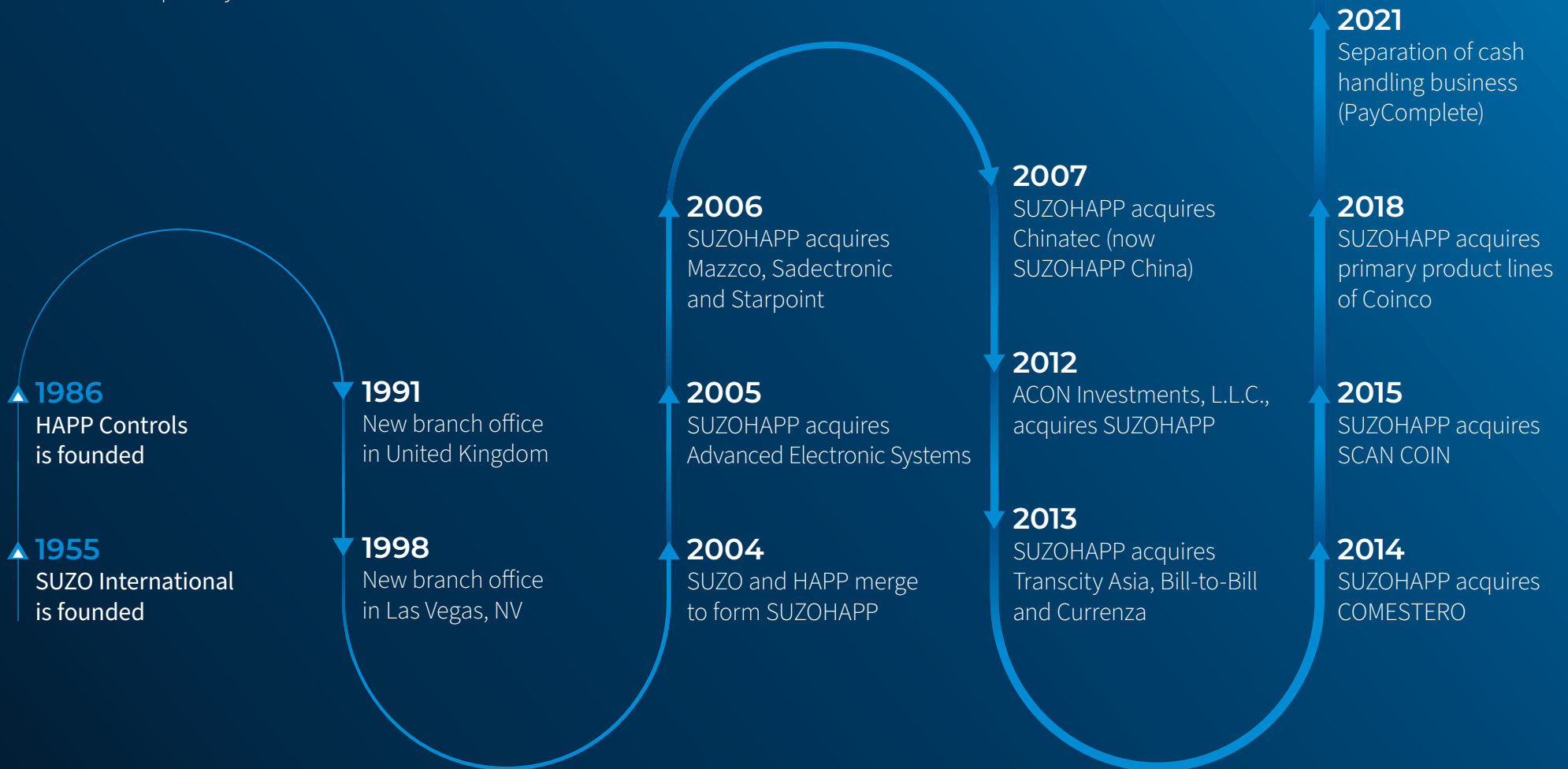

# Why Choose Us



## Industry Experts

We have successfully supported the Gaming and Sports Betting industries for decades by creating custom designs and supplying quality, proven components. We are a knowledgeable partner eager to help you succeed, so let us ease the burden of hardware so you can focus on your platform.

## Network & Inventory



Our global network of partners supplies us with industry-proven components that have great reputations within the market. Inventory of these products allow us to outfit your operation with best-in-the-industry hardware that will help lower your total cost of ownership.

      ... and many more!



## Fast & Flexible

We are uniquely able to quickly customize to suit your needs. We are platform agnostic with an established supply chain allowing us to source components quickly. Our facilities are strategically located to ensure ease of access to markets and quality without sacrificing on price or expedient delivery.

## Certifications & Experience



We have been supporting the European sports betting industry for nearly 10 years so have a thorough understanding of the market and have over 126 licenses and counting already in place allowing us to easily execute wherever your business is. We are competent at conforming to and certifying hardware to the following standards: CE, FCC, UKCA, CB, UL, GLI, and can assist in expediting the process to get your product to market quickly.

**SUZOHAPP — The Single Source For All Your Hardware Needs!**



# A Complete Sports Betting Experience

Whether at the bar, behind the counter, or on the sports book floor, your customers can place their bets how they want, where they want.



If you're looking for a customized solution, leverage our experience and let us guide you through the decision-making process and enable you to make informed choices from the industry experts, removing the burden of designing your retail solution.

**Regardless Of Venue, We Can Design A Solution For You!**

# From Concept to Delivery

We provide end-to-end service by determining the best solution for your customers, designing, prototyping, manufacturing, installing, and maintaining the terminal so that your concentration can stay where it should — on your game.



## Legislative Requirements And Safety

We are competent at conforming to and certifying hardware to the following standards:



## Our Design Process

- 1 Evaluate your venue and end customer
- 2 Design options based on your needs
- 3 Review designs and provide high-quality component options
- 4 Design and manufacture a prototype
- 5 Review prototype and integrate software
- 6 Submit prototype for certification
- 7 Manufacture and install units
- 8 Maintain and update as needed



# R&D Capabilities

Investment in research and development is a top priority. Global product management teams meet continuously to develop new products and custom solutions for customers' ever-changing needs.

Dedicated industrial, mechanical, and electrical engineering teams provide complete design, as well as component selection. SUZOHAPP utilizes contemporary modelling technology to produce accurate designs with competitive costs and short lead times.



# Our Manufacturing

With many years of industry experience and production excellence, SUZOHAPP has developed innovative customer-centric engineering and manufacturing processes.

With manufacturing centers in the United States (Chicago and Las Vegas), Poland, and China, we can provide appropriately localized products from the place where quality and value meet.



## Maintenance

**Our extensive array of components, given the nature of our business, allows us to help you succeed.**

- All designs are made with longevity and prolonged use in mind
- Distribution centres all over the world allow for quick and fast delivery, minimizing downtime and keeping your customers happy
- We offer advanced parts replacement, ready to dispatch as needed
- Simple designs make service easy

We are happy to design a service plan to suit your specific needs if desired.

# SBT

## SPORTS BETTING ECOSYSTEM

- ▶ SBT-1000
- ▶ SBT-2000
- ▶ SBT-500
- ▶ SBT-500+
- ▶ SBT-OTC
- ▶ CashIO Self-Service  
Payment Terminals (CRT's)





# SBT1000

## Sports Betting Terminal

- ▶ Intel 4-Core i3-8100T, 8GB RAM, 128GB SSD (expandable to 64GB/256GB)
- ▶ Dual Elo Touch 21.5" PCAP LCDs
- ▶ CUSTOM MODUS3 thermal roll printer w/ cutter, anti-jam technology
- ▶ Choice of Bill Validators:
  - JCM UBA PRO (500 note cashbox)
  - MEI SC Advance (SCNxx 600 note cashbox)
  - ITL NV200 Spectral (500 note cashbox)
- ▶ Newland FM430 scanner
- ▶ Optional RM5 HD Coin Acceptor
- ▶ Optional Magtek MT-215 Insertion Card Reader

### Features

- RGB LEDs – 7 colors selectable through switches
- Super-durable baked-on powder coatings
- Custom colors/backlighted logo
- Soft power up/down key switch
- Software-accessible low paper sensor
- Printer and peripheral power-saving features
- Universal power supply, localized power cable
- UL, CE, international EMC and safety certifications
- GLI-20 certified cabinet, designed to pass GLI-33 with platform software

Other peripherals and customization options are all possible

Customisable illuminated logo



**The modularity of the SBT-1000** enables you to choose from two different display options. You can have it set up as a **single-screen** or **dual screen** version.

## Security with Keyed-Different Access Levels

- Printer paper door sensor
- Note/coin unjamming door sensor
- Cashbox door sensor
- Additional cashbox security strap
- Computer access door sensor
- Soft power on/off keyed-switch
- Service mode keyed-switch

## Design and Production Quality

- Welded seams
- Quality harnessing
- ISO 9001, UL-Certified production sites

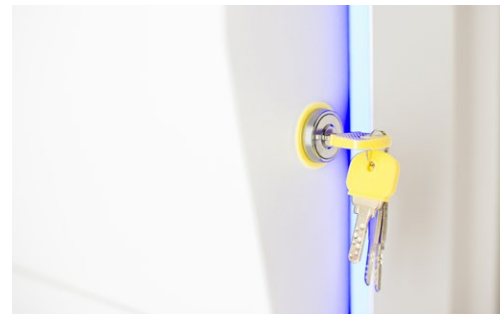
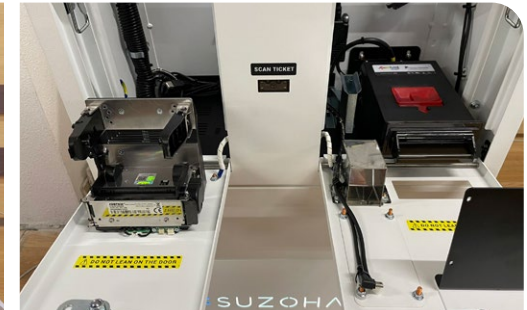

## Dimensional Drawing

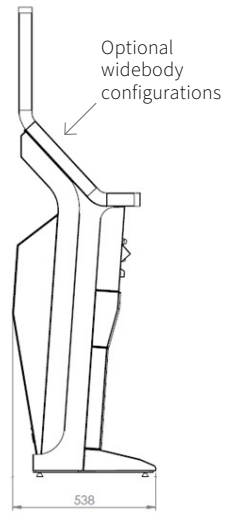
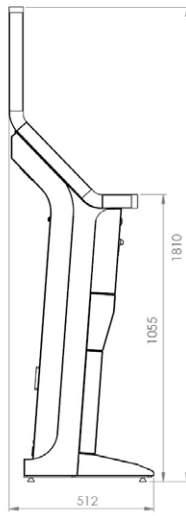
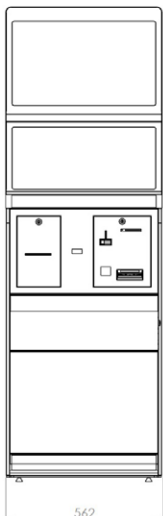



NEW!

# SBT2000

## Seated Sports Betting Terminal

- ▶ Intel 4-Core i3-8100T, 8GB RAM, 128GB SSD (expandable to 64GB/256GB)
- ▶ Dual Elo Touch 27" PCAP LCDs (Single screen option available)
- ▶ CUSTOM VKP80III Printer with 150mm paper roll
  - TransAct Epic Edge TITO printer optional as dual printer
- ▶ Choice of Bill Validators:
  - JCM UBA PRO (500 note cashbox)
  - MEI SC Advance (SCNxx 600 note cashbox)
  - ITL NV200 Spectral (500 note cashbox)
- ▶ Newland FM3080 scanner for phone or ticket
- ▶ Optional RM5 HD Coin Acceptor
- ▶ Optional Magtek MT-215 Insertion Card Reader

### Features

- Software-controllable full spectrum RGB LEDs
- Super-durable baked-on powder coatings
- Soft power up/down key switch
- Keyed-different printer, cash, and computer door locks with sensors
- Universal power supply, localized power cable
- Designed to be ADA Accessible
- Designed to meet GLI 33, UL, and CE specifications

Other peripherals and customization options are all possible

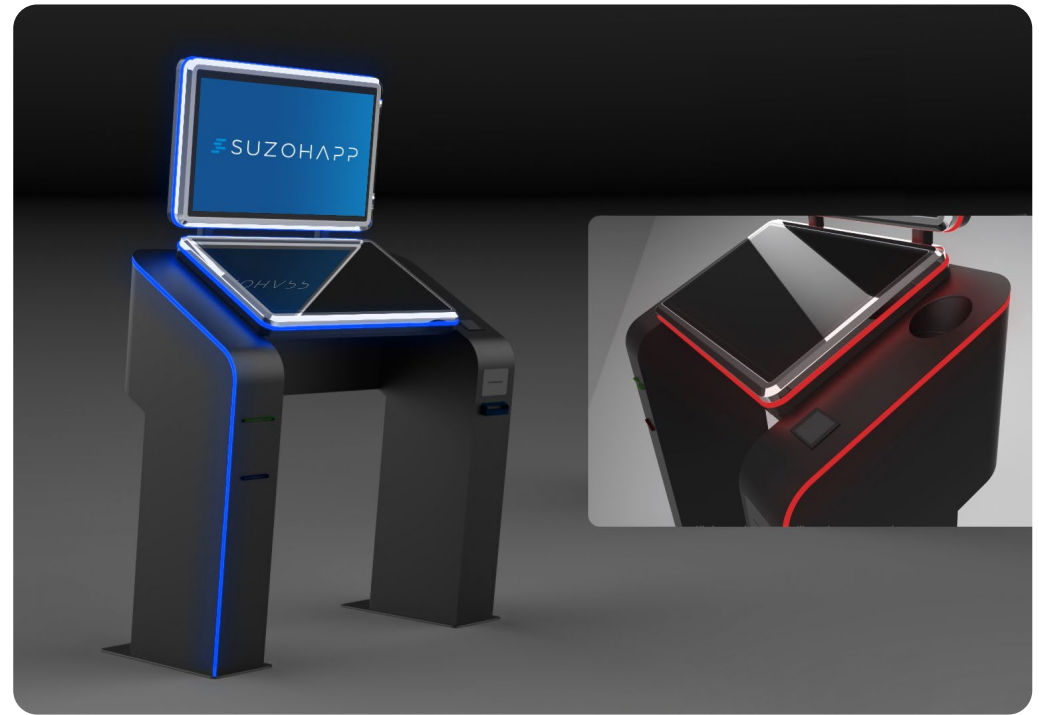

### Dimensional Drawing

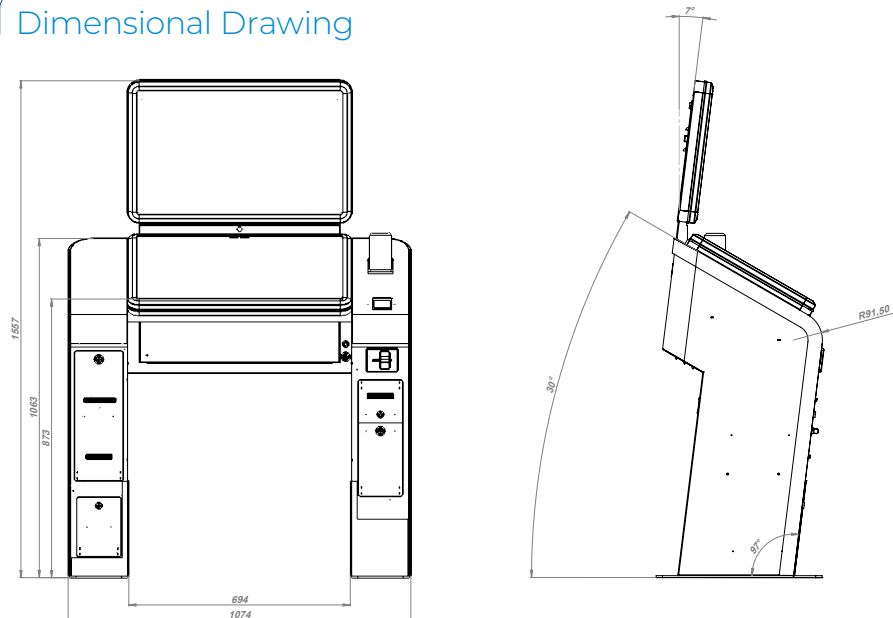

# SBT 500

## Cashless Sports Betting Terminal

- ▶ Intel 4-Core i3-8100T, 8GB RAM, 128GB SSD (expandable to 64GB/256GB)
- ▶ Elo Touch 15.6" widescreen PCAP LCD
- ▶ CUSTOM MODUS3 80mm thermal roll printer w/ cutter, anti-jam technology
- ▶ Newland FM3080 scanner for phone or ticket
- ▶ Optional Magtek Mini 3-Stripe MSR

### Features

- Software-controllable full spectrum RGB LEDs
- Software-accessible low paper sensor
- Keyed-different printer and computer door locks with sensors
- Service mode key switch
- Soft power up/down key switch
- Super-durable baked-on powder coatings
- Secure table mounting — cables exit through rear or base
- Printer and peripheral power-saving features
- Universal power supply, localized power cable
- UL, CE, international EMC, and safety certifications
- GLI-33 certified terminal



Optional Card Reader



Sealed Spill-Proof Design  
9° Slant – No Drink Placement

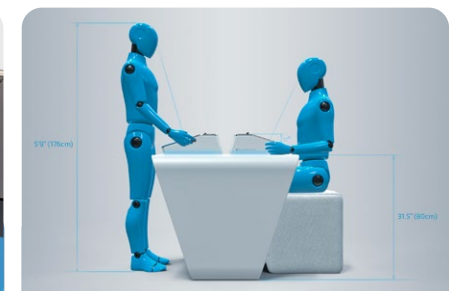

Engineered for Various  
Viewing Angles



### Security with Keyed-Different Access Levels

- Printer paper door sensor
- Computer access door sensor
- Soft power on/off keyed-switch
- Service mode keyed-switch

### Design and Production Quality

- Welded seams
- Quality harnessing
- Fingerprint-resistant chrome and paint
- Durable steel alloy internal locking mechanisms
- ISO 9001, UL-Certified production sites



### Dimensional Drawing

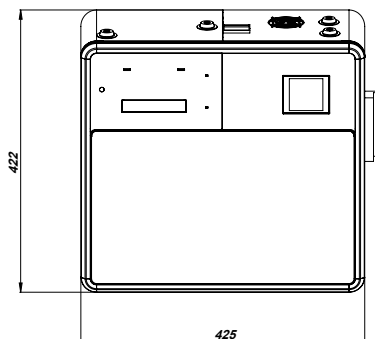
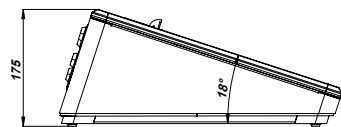
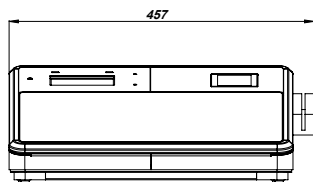

**NEW!**

# SBT 500+

## Bartop Sports Betting Terminal with Bill Validator

- ▶ Intel 4-Core i3-8100T, 8GB RAM, 128GB SSD (expandable to 64GB/256GB)
- ▶ Elo Touch 15.6" widescreen PCAP LCD
- ▶ CUSTOM MODUS3 80mm thermal roll printer w/ cutter, anti-jam technology
- ▶ Newland FM3080 scanner for phone or ticket
- ▶ Choice of Bill Validators:
  - JCM UBA PRO (500 note cashbox)
  - MEI SC Advance (SCNxx 600 note cashbox)
  - ITL NV200 Spectral (500 note cashbox)
- ▶ Optional Magtek Mini 3-Stripe MSR

### Features

- Designed to fit within bartop and undercounter footprint of popular bartop poker terminals
- Software-controllable full spectrum RGB LEDs
- Software-accessible low paper sensor
- Keyed-different printer, cash, and computer door locks with sensors
- Service mode key switch
- Soft power up/down key switch
- Super-durable baked-on powder coatings
- Printer and peripheral power-saving features
- Universal power supply, localized power cable
- International EMC and safety certifications
- Designed to pass GLI-33 with platform software



Encourage In-Play Bets



Sealed Spill-Proof Design  
9° Slant – No Drink Placement

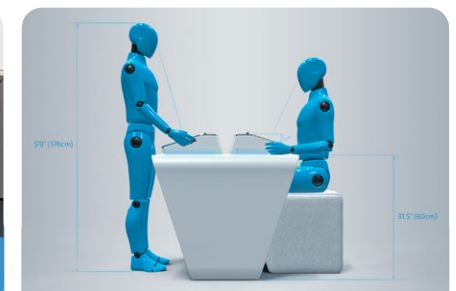

Engineered for Various  
Viewing Angles

# SBT OTC

## Over-the-Counter Sports Betting Terminal

For your more traditional customer, or in an area where you need controlled betting, allow your cashier to manage all the bets. The SUZOHAPP OTC offering is modern and modular, utilizing the same core component engines as SUZOHAPP's kiosk SBTs to ease the software development, performance, and certification across form factors.

### Standard Configuration and Accessories

Consists of an Intel i3 processor, 15" display, and optional 10" customer facing display via a single cable USB-C connection. The I/O hub includes 7 USB ports (including powered USB), 2 serial ports, and a cash drawer port. Additionally up to 4 integrated peripherals can be added to the display edges (i.e. MSR, RFID reader, EMV cradle, webcam, fingerprint scanner, status light).

### Flexibility / Options

Options include choice of processor (Celeron, i3, i5) with RAM and storage expansion, main display size (15", 15" wide, 17", 21.5"), secondary display (10.1" or 13.3" with or without touch), in countertop or wall mount configuration. Other printers and scanners when required.

- ▶ Intel 4-Core i3, 8GB RAM (up to 64GB), 128GB SSD
- ▶ 15" PCAP touchmonitor
- ▶ CUSTOM P3 thermal roll printer w/ cutter
- ▶ Newland HR3280 scanner
- ▶ 3-year global warranty on the computer, 5 years on the scanner
- ▶ Global certifications

### Different Form Factor with Ease of Integration

- Same computer platform for front and back of house units
- Same manufacturer of scanners, printers, and card readers

### Options

- Computer performance and storage
- Card readers, webcam
- Various display sizes
- Rear facing customer displays with or without touch
- Other printers and scanners when required



Shown with optional 13.3" customer display and MSR





# CashIO Self-Service Payment Terminals (CRT's)

## Allow customers an easy cash-out or continuation of play experience

- ▶ CashIO is a versatile system with all the features needed to support casino operators at every level.
- ▶ Since the CashIO automates cashier operations, it not only reduces cash handling costs but also offers players improved service.
- ▶ Allows the simultaneous use of banknotes, coins, and cashless media such as tickets and cards (TITO–ticket-in / ticket-out).
- ▶ CashIO Gold (far right) and CashIO Silver (right) both have small footprints to provide maximum floorspace to your terminals. Differences include ATM capabilities (Gold only) and bill storage capacities.
- ▶ 2Pay is the gaming industry's smallest form factor self-service kiosk for Point Of Sale (POS) Debit card to TITO ticket transactions.

The gaming machine issues players a ticket representing customers' winnings. With the ticket, they can either move on to another slot machine or go to the CashIO terminals, where they can collect their winnings without standing in line at the cashier's cage. CashIO is able to print tickets for the coin change during redemption transactions.

### TICKET REDEMPTION

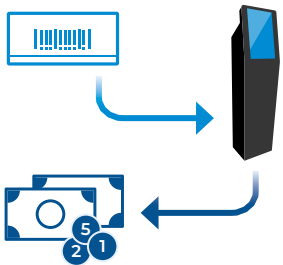

### CARD MANAGEMENT: Pay out of winnings or credits on the player card

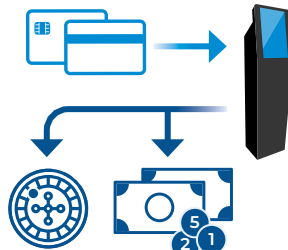

### BILL BREAKER

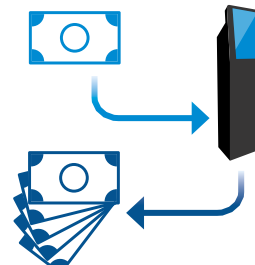

### All-in-One Cashless redemption and issuing payment terminal:

- Multi-medium interfaces
- Redeems and prints TITO/2D/QR tickets
- Card issuing, recharge, and redemption for Mag. stripe/Chip/ RFID/NFC cards
- Pays out card balances down to the cent with banknotes and coins
- Mobile bank transfers
- Multi-platforms payment (casino, route gaming, VLT, sports betting, bingo, pull-tab, lottery, etc.)

### Operational efficiency and cost saving features:

- Coinless options: Change donation, Ticket redemption rounding, Ticket as change
- Ticket purchase with POS Debit transaction to optimize cashflow
- Face recognition and biometric login
- User instructions provided via touchscreen with multiple language/multiple currencies
- Breaks large denomination banknotes into several smaller ones (configurable)



### Technical Specifications

	Gold Edition	Silver Edition
Number of note cassettes	3-4	4
Capacity of note cassettes	1500 each	500 each
Note acceptor capacity	1000	1000
Coin denominations	Up to 4	Up to 4
Recommended transactions per day	500	250
Touch screens	24" or 32"	10" or 21"
Receipt printer	Ticker printer	Ticker printer
Available options	Pin Pad; Dip Card Reader; Motorized Card Reader; Ticket Redemption; Ticket Issuing; Card Redemption/Charge; Card Issuing; Jackpot Payout; POS, ATM, Cash-N-Go; Biometric Sensor; Electronic Lock For Safe Door; Advertising; Multi Currency	Camera; Dip Card Reader; Motorized Card Reader; Ticket Redemption; Ticket Issuing; Card Redemption/ Charge; Card Issuing; Advertisement; Multi Currency

# COMPONENTS FOR GAMING MANUFACTURERS

- ▶ Monitors
- ▶ Signage & Computing Power
- ▶ Printers & Scanners
- ▶ Toppers
- ▶ Mechanical Devices
- ▶ Coin Validators & Hoppers
- ▶ Bill Validators & Ticket Dispenser
- ▶ Locks
- ▶ Spare Parts





# UPGRADE your GAME

with our **NEW MONITORS LINE!**

**COMPATIBILITY  
WITH ALL POPULAR  
VERTICAL GAMES!**

» **43"**  
**TOUCHSCREEN LCD  
WITH LED LIGHTS  
CURVED DESIGN**



This monitor can be mounted horizontally or vertically. It has a curve design to add extra wow to your game cabinet. LEDs are arranged around the monitor for a seamless look integrating it with the front glass. The LED lights can be set to different modes and colors to achieve desired combinations.

### Features

- Front facing LED lights
- Serial & USB touchscreen connections
- VGA and HDMI video inputs
- Total dimensions: 40" tall x 24" wide
- LCD inner display dimensions: 36 3/4" tall x 20 3/4" wide
- Displays bright & vibrant colors
- Includes VGA, Serial & USB cables for video & touchscreen hook-ups
- Monitors have a high-definition native resolution of 1920 x 1080 @60hz
- Monitors are capable of 4k resolution
- 3 year warranty
- No external controller needed

## » 43" TOUCHSCREEN LCD WITH LED LIGHTS



This monitor can be mounted horizontally or vertically. LEDs are arranged around the monitor for a seamless look integrating it with the front glass. The LED lights can be set to different modes and colors to achieve desired combinations.

### Features

- LED display
- Front facing LED lights
- Serial & USB touchscreen connections
- VGA, DVI and HDMI video inputs
- Total dimensions: 39 7/8" tall x 23 5/8" wide
- LCD inner display dimensions: 37" tall x 20 3/4" wide
- Displays bright & vibrant colors
- Includes VGA, Serial & USB cables for video & touchscreen hook-ups
- Monitors have a high-definition native resolution of 1920 x 1080 @60hz
- Monitors are capable of 4k resolution
- 3 year warranty
- No external controller needed

## » 32" TOUCHSCREEN LCD WITH LED LIGHTS



This monitor can be mounted horizontally or vertically. LEDs are arranged around the monitor for a seamless look integrating it with the front glass. The LED lights can be set to different modes and colors to achieve desired combinations.

### Features

- LED display
- Front facing LED lights
- Serial & USB touchscreen connections
- VGA, DVI and HDMI video inputs
- Total dimensions: 31 3/4" tall x 19 5/8" wide
- LCD inner display dimensions: 27 1/2" tall x 15 1/4" wide
- Displays bright & vibrant colors
- Includes VGA, Serial & USB cables for video & touchscreen hook-ups
- Includes LCD power supply & power cord
- Monitors have a high-definition native resolution of 1920 x 1080 @60hz
- 3 year warranty
- No external controller needed



HIGH QUALITY LCDS FOR GAMING, AMUSMENT, SPORTS BETTING, LOTTERY AND BINGO

# elo Touch Solutions

World-Class Quality, Global Approvals and Support  
Distributed globally by SUZOHAPP

Elo is the world leader in commercial touch with over 20 million installations, half a million units per year, nearly 2,000 units per day. And SUZOHAPP is the world's largest distributor of this premium open frame product line.

Engineered and designed specifically for the demanding requirements of the gaming industry, the 90-Series open-frame displays feature integrated touch technology rather than glued-on additions. Select from a wide range of sizes from 10" to 27" to fit in any gaming environment. Elo products extend the range to 65".

- ▶ Next generation Projected Capacitive (PCAP) 2GS technology (2 glass solution)
- ▶ Highest optical quality and longevity as no plastic films, no metal mesh
- ▶ 10-touch true-flat solution
- ▶ Thru-glass mode which operates through up to 6 mm customer-supplied glass
- ▶ Common mechanical and electrical components across the line for easy design-in, compliance testing, service, and transition between sizes
- ▶ HDMI, DisplayPort, VGA inputs, with common port design across all units
- ▶ Built-in watertight edge seal
- ▶ Magnetic tethered OSD control box
- ▶ Unique field-replaceable touchscreen glass design
- ▶ Global agency approvals: United States UL, FCC; Europe CE TÜV; Australia RCM; Canada cUL, IC; China CCC; Japan VCCI; Korea KCC; Mexico CoC; Taiwan BSMI; International CB; RoHS
- ▶ Passes UL and IK07 Ball Drop tests
- ▶ 50,000 hour demonstrated MTBF
- ▶ 3-year standard global warranty



## 10" to 27" Desktop Touchmonitors, All-in-Ones and Interactive Digital Signage from 10" to 65"

SUZOHAPP also distributes the complete line of Elo Touch Solution products — seen in cashier cages, sports betting outlets, and on the gaming floors in top casinos around the world. Monitors and All-in-Ones for front/back office, interactive digital signage, bingo, lottery, sports betting, player tracking, loyalty systems and pos.





## HIGH QUALITY LCDS FOR GAMING, AMUSMENT, SPORTS BETTING, LOTTERY AND BINGO

# VisionPro™

## High Quality LCDs

VisionPro™ is SUZOHAPP's premium line of LCDs using top panel brands and high-quality boards.

**Fast customization** is available for both OEMs and upgrades: 6.2" to 90", specialized panels and integration, customized metal, oversized glass, touchscreens and inputs. Send us your requirements, and we can design/build to match.



## Touch and Non-Touch

- ▶ Standard sizes from 15" to 43", smaller and larger sizes available with fast customization
- ▶ Up to 4K resolution
- ▶ Choice of:
  - 10+ touch Projected Capacitive (PCAP), true-flat, seamless edge-to-edge glass with thru-glass capability
  - 3M Surface Capacitive (SCAP) touch technology
  - Protective Glass
- ▶ Standard and wide viewing angle units available
- ▶ Common footprint for touch and non-touch variations
- ▶ DVI, VGA, HDMI and DisplayPort input options
- ▶ Economically priced
- ▶ Models also available with LEDs surrounding the display with colour

## LED-Framed Monitors

- ▶ Rigid high-quality PCB-mounted LEDs, no adhesive strips, no hotspots, no dark corners
- ▶ True-flat, black closed-frame designs
- ▶ **21.5"/ 23.8"**: 250 cd/m<sup>2</sup>, 1000:1 - **27"**: 300 cd/m<sup>2</sup>, 3000:1  
**32"**: 400 cd/m<sup>2</sup>, 1200:1 - **32" (P)**: 500cd/m<sup>2</sup>, 3000:1  
**43"**: 450 cd/m<sup>2</sup>, 1100:1 - **43" 4K UHD**: 500 cd/m<sup>2</sup>, 4000:1
- ▶ FHD 1920x1080, WVA 178°x 178° for landscape or portrait usage (43" 4K UHD 3840x2160)
- ▶ 10-touch PCAP for Windows 7 or later, Linux 4.4 or later
- ▶ Dual-line LEDs in Addressable versions
- ▶ VGA + DVI standard, HDMI and DisplayPort available (4K UHD: HDMI/DP only)
- ▶ 12VDC (24VDC for 32", 43"), optional 100-240V AC brick
- ▶ Operating temperature: 0-50°C (32-122° F)
- ▶ FCC, CE, RoHS
- ▶ Drawings and CAD files available on request
- ▶ Customization possible

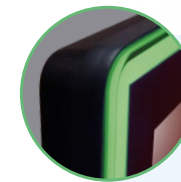

### FRONT DESIGN

For mounting monitor flush inside your cabinet.

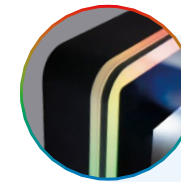

### EDGE DESIGN

For front and edge illumination, external use.



### HALO DESIGN

For floating monitor outside your cabinet. Surround colour in front, side, rear for a halo effect.

# Interactive Digital Signage

## Create Immersive Interactive Experiences

Elo is the world leader in commercial touch with over 20 million installations, half a million units per year, nearly 2,000 units per day. SUZOHAPP globally distributes the complete line of Elo Touch Solution products seen in cashier cages, sports betting outlets, and on the gaming floors in top casinos around the world.

- PCAP 40 Touch with Palm Rejection and Touch Thru capability
- Supports up to 6mm glass/3mm plastic with up to 2 touches. Supports gloves up to 1.4mm
- 2x HDCP-capable HDMI on Type A connector; DisplayPort 1.2 connector; USB-C connector
- 50,000 hour demonstrated MTBF
- 3-year standard global warranty
- Regulatory approvals and declarations: UL 62368-1; FCC (US); cUL, IC (Canada); CB (International safety); (IEC/EN60950-1+IEC/EN62368-1); CE (Europe); VCCI (Japan); RCM (Australia); CCC, China RoHS (China); EAC (Russia); NOM (Mexico)
- Passes UL and IK07 Ball Drop tests
- Sleek, slim design



From 32- to 65-inches, choose the interactive display size that fits each space perfectly!

## Add Windows Computing Power with Ease

The commercial-grade computer module transforms the touchscreen monitors into powerful, all-in-one, touch computer platforms with compatibility with most content-management servers.



## Add Android Computing to Elo Touchscreens

Powered by EloView®, content delivery and remote management of your entire network has never been easier. The low-power, solid-state, fanless computing solution offers everything needed in an affordable, compact design.



# BluMax™

## Sports Betting / Kiosk PC Platform



BluMax™ industrial PC platform, ideal for Sports Betting Terminals and other kiosks. The BluMax™ features a 10th generation 8-core Intel® i3 processor packaged in a compact chassis of only 200 x 200 x 36 mm.

BluMax has a long lifecycle — 7+ years no changes — separating it from frequently changing consumer PCs that require mechanical changes, product re-qualifications, governmental and jurisdictional re-certifications, and compatible field replacement units.

Features include LED lighting for an impressive demonstration of your kiosk internals, easy/secure mounting bracket, and a practical header that allows the power button to be relocated anywhere in the kiosk, including an external key-switch. Windows and Linux compatible.

Customization options including other processors, RAM/storage, and enclosure options.

### Technical Specifications

<b>Processor</b>	Intel® Core™ 10th generation i3-10100TE processor 2.30GHz (4 core/8 threads, up to 3.6GHz, 6M cache)
<b>Chipset</b>	Intel® H420E
<b>Socket</b>	LGA1200 for Intel® Core™ i7/i5/i3/Celeron®, up to 65W
<b>Graphics</b>	Intel® UHD Graphics 630, 4K support
<b>Video Output</b>	1x HDMI 1.4a and 1x DP++ 1.2 -or- 2x DP++ (passive/straight-through cable adapters available to single-link HDMI or DVI monitors) DP resolution up to 4096 x 2304 @ 60Hz HDMI resolution up to 3840 x 2160 @ 24Hz
<b>Memory (RAM)</b>	8GB, expandable to 16 GB (1 of 2 260-pin DDR4 SO-DIMM sockets) Data transfer rates up to 2400/2666/2933 MT/s 64 GB* Intel® Core i3/Pentium®/Celeron® CPUs support up to 32 GB (16 GB per DIMM) *Intel® Core i5/i7/i9 CPUs support up to 64 GB (32 GB per DIMM) Vertical type memory socket (low profile)
<b>Storage</b>	128GB SSD (2242/M.2 SATA)
<b>TPM</b>	TPM2.0 SPI interface Infineon SLB9670VQ2.0 / Nuvoton NPCT750 (option)
<b>USB Ports</b>	6x USB 3.2 Gen1
<b>COM Ports</b>	1x DB9 COM port
<b>LAN</b>	1x Intel® Gigabit Ethernet PHY I219LM -or- 1x Realtek GLAN RTL-8119I-CG (depending on chip availability)
<b>Audio</b>	Line-out / Mic-in 3.5mm combo audio jack Realtek® ALC897 HD codec (colay ALC888S)
<b>Power</b>	12V/120W (power supply not included) DC Jack-3.5x2.5mm w/ locking connector
<b>Dimensions (WxDxH)</b>	200 x 200 x 36 mm / 7.9" x 7.9" x 1.5"
<b>Case</b>	Aluminum chassis painted black with mounting plate and internal blue LEDs
<b>Power Button</b>	Header for remote (key-switch) power button
<b>Temperature</b>	Operating: 0~40°C / Storage: -20~60°C
<b>Humidity</b>	Operating: 10%~90%
<b>Weight</b>	1.9 kg (unpacked)
<b>Warranty</b>	2 years
<b>Lifecycle</b>	7 years minimum ("Comet Lake", launched in 2020)
<b>Certifications</b>	CE, FCC, UKCA (pending)



# Kiosk / Self-Service Printers

**CUSTOM**<sup>®</sup>



## MODUS3

54-82.5 mm Small Footprint Kiosk Printer

This ultra-compact thermal printer meets the needs of slim-line kiosks without sacrificing features or functionality. The MODUS3 combines all the benefits of a self-service printer in a compact package (116Lx50Dx62H mm).

**NEW** New Options

- Paper roll support up to 150 mm (6")
- Presenter supporting a 30 cm ticket loop at 200 mm/s. The printer remains ultra compact with an overall depth of 85 mm



## TG02H

Extremely Compact and Versatile 57 mm Ticket Printer

Designed for easy installation and panel mounting, the TG02H is an extremely compact (129Lx120Hx100W mm) and versatile ticket printer and includes a patented anti-jamming system.



## TG2460HIII

60 mm Ticket / Receipt Printer

60 mm receipt and ticket printer with a metal frame and paper mouth that includes a blocking system to prevent insertion of items. Available in cutter and tear-off versions, 12V version (TG1260), and with illuminated plastic bezel.



## TG2480HIII

80 mm Ticket / Receipt Printer

80 mm receipt and ticket printer with a metal frame, static presenter, and an exclusive patented anti-jamming system.



## VKP80III

50-82.5 mm Ticket / Receipt Printer

The worldwide best seller in the kiosk industry! Compact 50 to 82.5 mm ticket and receipt printer (143,5Lx76,4Hx116W mm) with fast printing and low TCO (Total Cost of Ownership). Available with shutter for outdoor use to prevent introduction of objects.

# Lottery & Sports Betting

**CUSTOM**<sup>®</sup>



## KUBE II LOTTERY

Printer for Lottery, Gaming and Betting

KUBE II LOTTERY is a high-performance thermal printer suitable for applications in the lottery and betting sectors. It features high-quality printing combined with sturdiness and reliability, along with stacking capabilities.

## KUBE II SCANNER

Printer for Lottery, Gaming and Betting

KUBE II SCANNER is the combination of a high-performance scanner for cards and betting slips, and a high-speed thermal printer with a stacker unit. This printer features embedded OMR and barcode reading capabilities for coupons and betting slips and also includes a ticket void feature. A complete solution all in one product!

## K3 LOTTERY

Printer for Lottery, Gaming and Betting

K3 LOTTERY is the new Custom printing solution designed for the lottery, gaming and betting sectors, with an 80 to 82.5 mm paper width and 203 mm roll diameter to ensure exceptional functionality. It features a motorized stacker with a capacity of up to 100 tickets and includes our patented anti-jamming and auto-recovery system.

## A6 SCANNER

A6 Document and Check Color Scanner

Front/back A6 color scanner guarantees high performance (400 mm/s) with a resolution up to 300 dpi, along with the option of integrating with third-party applications. It is supported by an MICR head for scanning CMC7 magnetic strips on international checks and it has the smallest footprint in its class (115Lx76.1Hx166.5W mm), which enables it to be used for access control systems.

# Epic Edge

## TITO Printer

**TRANSACT®**

Featuring an unmatched 300 DPI print quality, a high-speed firmware uploading solution and a single interface board for all games, there is no question about it. Have an “Edge” over the rest with the most innovated printer on the market.

The Epic Edge is built on the reliability of the Epic 950, which is so dependable that less than .03 percent of casinos have reported any sort of failure with the printer during the initial warranty period. We expect that number to decrease even more with the “Edge.”

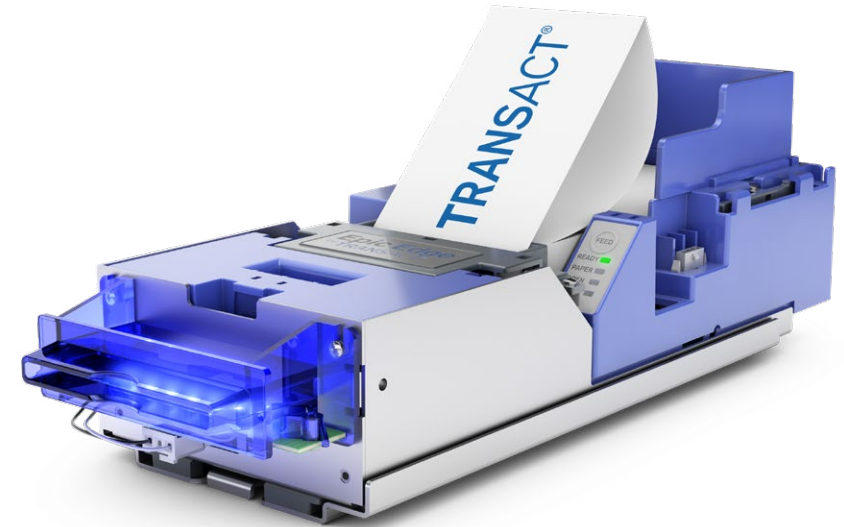

### 300 DPI

Featuring an unmatched 300 DPI print resolution, the Epic Edge improves ticket readability and acceptance by bill validators, all while enabling casino operators to print eye-catching promotional coupons and bonus tickets with Epicentral.



### Speedy Firmware Uploading

Faster than ever, the printer has two additional high-speed interfaces to simplify firmware updates and graphic downloads. A micro SD card updates the printer with no need to carry a laptop or turn off the slot machine.

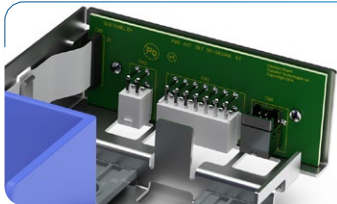

### One Printer for All Games

The Epic Edge is fully equipped with serial and USB interfaces that are all conveniently built into a single board. This means you only need to inventory a single printer, for any game.

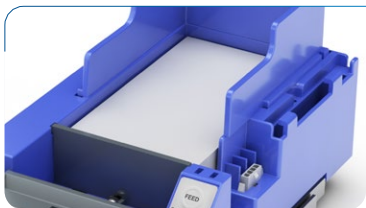

### Eco-friendly Tickets

The “Edge” contains an adjustable ticket bucket that allows operators to use smaller, paper-saving tickets to work with ecological programs being implemented in casinos.

## Technical Specifications

<b>Scan Resolution</b>	300 dpi
<b>Print Width</b>	2.44 in / 62 mm
<b>Print Speed</b>	5 inches per second, 125 mm per second
<b>Dimensions</b>	4.46W x 11.25D x 2.66H (inches) 113.3W x 285.75D x 67.6H (mm)
<b>Weight</b>	3.8 lbs / 1.7 kg
<b>Interface</b>	Single Board: USB, Serial, Netplex™
<b>Power Supply</b>	24 VDC: 2.2 Amps Maximum
<b>Operating Temperature</b>	41 to 140 F at 10 to 90% RH 5 to 60 C at 10 to 90% RH
<b>Storage &amp; Shipping Temperature</b>	14 to 122 F at 5 to 90% RH -10 to 50 C at 5 to 90% RH
<b>Print Head Life</b>	43.45 miles / 70km
<b>Reliability</b>	Less than .03% failures (3 per 10,000)
<b>Memory Capacity</b>	8MB RAM and 4MB Flash for printer operation



# Stationary Scanners



## FM3080

Impressive short-range scanning capabilities combined with customization

Prepared for integration in your kiosk or counter, the FM3080 Hind combines performance and customization. The large scan window is optimized for short range reading of barcodes from a mobile phone or paper, even placed directly on the glass. With 4 color options available, the FM3080 Hind can be easily programmed to indicate a successful read or to match your brand.

## FM3051/FM3056 Grouper II

Plug-and-play simplicity enhancing your experience right from the start

With its snappy barcode reading of virtually any 1D or 2D barcode, the FM30 Grouper II Series is the perfect response to the trend of barcodes moving from paper to the screen. Built to read from contemporary LCD widescreen devices, the fixed scanner is ideal for mobile phone applications like loyalty programs and ticket validation. The form factor and small footprint of the FM30 Grouper II Series makes it easy to integrate into a kiosk. Also available in flush mount: the FM3056 Grouper II.

## FM430 Barracuda

Read barcodes from short or long range with this compact scanner for when less space is available

The new FM430 Barracuda is Newland's most aggressive and efficient fixed mount scanner to date, making it a strong all-around solution. It's equipped with a megapixel camera that scans virtually any 1D and 2D barcode with impressive speed and ease. On top of that, its programming, IR sensor and light sensor help keep users moving, even in low light conditions. The combination of these features makes the device a leader in its class.



Newland scanners are supported by *EasySet* – a software tool for configuration, cloning setup for fast deployments, firmware upgrades, imaging functions, and includes a barcode generator.

# Stationary Scanners



## FM100

Reading performance reaches and exceeds global standards, advanced CCD scan engine

Designed for OEM applications, this high-performance fixed scan engine can easily be integrated into various solutions such as kiosks, ticketing machines, (reverse) vending machines and many more. CCD technology means no laser, mirror or moving parts for increased durability.



## FR27

Latest technology, compact design, CPU-based scanner

Armed with Newland's latest-generation UIMG® technology, the FR27 can decode poor quality soiled or wrinkled barcodes with ease, even on a screen covered with protective film. Its exceptional motion tolerance and large FOV enhance the user experience. Fits on a narrow desk or shelf when space is at a premium.



## FR21 Neon

Ideal desktop scanner for mobile payment, customer loyalty and ticket verification

The FR21 Neon was built to create an optimal customer experience at the POS. It scans quickly and easily, even for the most inexperienced user, making it an ideal solution for applications like mobile payment, customer loyalty, cashback, and ticket verification. "Scan here" circle customizable with any sticker.



Newland scanners are supported by *EasySet* – a software tool for configuration, cloning setup for fast deployments, firmware upgrades, imaging functions, and includes a barcode generator.

# SH1950 Video Topper

## 19.5" Wide Viewing Angle LCD

The SH1950 Video Topper consists of a 19.5" wide viewing angle panel, VGA, DVI, DP, HDMI and 12V inputs, and is equipped with a black bezel. All 4 sides have RGB LED illumination, covered by an acrylic front plate. FHD input resolution is supported for compatibility with most media players.

The SH1950 Video Topper is manufactured in SUZOHAPP China, in accordance with the highest standards. Final assembly, as well as customizations, are done at our local production facilities in the USA and Poland. Various mounting options are available for popular slot machines, and others can be customized.

The SH1950 Video Topper is a great addition to every cabinet!

### Features

- Optional classic chrome mini tower light with 2 or 3 lamps
- RGB LED illumination, covered by an acrylic front plate
- Optional without LCD to be used as a light box
- RGB optional with or without controller
- VGA, DVI, DP or HDMI connection
- Black feet included
- Optional external media player available
- CE, FCC and UL Certified

Contact your sales representative for more options and customization possibilities

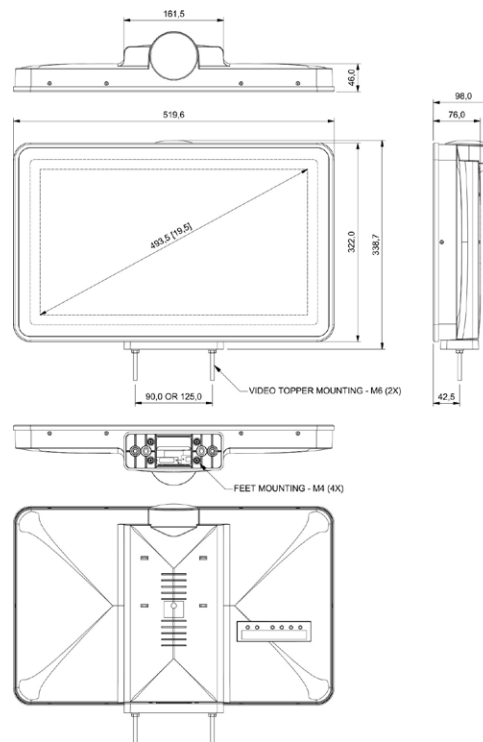

### Technical Specifications

Size (L x H x D)	519.6 x 338.7 x 98 mm
Screen Diagonal	19.5"
Native LCD Resolution	1600 x 900
Supported Resolutions	1024 x 768, 1280 x 720, 1366 x 768, 1600 x 900, FHD 1920 x 1080 (downscaled)
Operating Environment	0-50°C, 10-90% RH
Viewing Angle	89/89/89/89 (Typ.) (CR≥10)
Brightness	250 cd/m <sup>2</sup> (Typ.)
Contrast Ratio	1000:1 (Typ.) (TM)
Response Time	14 (Typ.) (G to G)
Colors	16.7M



# Compact RGB Handle Mechanism

## Features

- Ultra low-profile design allows for external mounting on cabinet and provides increased space inside of the cabinet
- 3 versions including Standard, USB and SPI, with RGB lighting or no lighting
- Variety of handle rod colors including; Black, Chrome, Black Chrome, Gold or White
- Selection of 2 shapes of handle rod, standard or straight
- Lock-out Solenoid coil, in choice of 12VDC or 24VDC, providing a lock that prevents handle being pulled
- 2 choices of mounting stud, Metric or US standard
- Standard version includes set LED patterns and colors, or no lighting
- USB version provides control of LED pattern options, intensity and pattern speed, via a simple command set, or no lighting
- SPI version provides host control of LED lighting, or no lighting
- Easily removed for improved serviceability
- Ruggedized die cast design to provide long-term performance
- RGB attract mode on handle mechanism cover and ball, to attract additional attention



# Reel Mechanisms

Custom Engineered Reel Mechanisms to Fit the Needs of Our Customers



# RM5 HD

## Electronic Coin Validator



The RM5 HD coin validator has set new reference standards in coin validation. Through 5 different sensors and 10 recognition parameters, it ensures a high level of recognition and discrimination of valid and counterfeit coins with an unprecedented speed of up to 6 coins per second.

- ▶ High-discrimination system based on 10 different parameters
- ▶ 5-sensor identification technology
- ▶ High acceptance speed: up to 6 coins per second
- ▶ Advanced electronic and mechanical anti-fraud system
- ▶ Indicator LED
- ▶ Accessories include front plates, sorters, and funnels
- ▶ Compatible with all solutions available in the market

# Veloce

## Hi-Speed Coin Acceptor



Fast and reliable coin acceptance.

- ▶ High acceptance speed: up to 10 coins per second
- ▶ 16 programmable channels
- ▶ Precise measurement of the diameter thanks to the matrix system of 12 IR LEDs with interpolation of values
- ▶ Double digital magnetic sensor (hall)
- ▶ Large inductive sensor that allows uniform readings of the alloy as the coins pass through each position
- ▶ UV sensor for discrimination between coins with copper or nickel alloy
- ▶ Optical control of the coin collection and exit area
- ▶ Error diagnosis displayed by the 3 control LEDs
- ▶ Standard ccTalk interface
- ▶ Programming and updating via PC program (with Win7 to 11) with any USB-ccTalk interface

# Cube Hopper MK2

## The Ideal Coin or Token Dispensing Unit for Any Machines



Suitable for high payout speed dispensing (up to 400 coins per minute). Also available in the Dual Hopper version, which can payout 2 different types of coins.

- ▶ Standard 350 coins capacity (ø24 mm)
- ▶ Coin cup extensions available (optional) which increase capacity up to average 400 coins per extension (ø24 mm), maximum 2 extensions up to 25.6 mm
- ▶ High payout speed dispensing: up to 400 coins per minute
- ▶ A low-level detection integrated into connector as standard

# Flow Hopper

## Innovative Through-hole Hopper



### 3 DIFFERENT COIN BOWL SIZES

- ..... Medium Cup
- ..... Intermediate Cup
- ..... Large Cup

The Flow Hopper is a through-hole hopper suitable for various uses in gaming, vending, parking and change machines. The innovative electronics and high-resistance plastic materials ensure durability over time. Available in two versions: standard parallel and ccTalk.

- ▶ Compatible with other hoppers already on the market
- ▶ Available with three different coin bowls: medium, intermediate, large
- ▶ Integrated fall tube for simple dual hopper cabinet construction
- ▶ Parallel interface and 10-pin connector
- ▶ Low level sensor and anti-jam feature
- ▶ High payout speed of about 7 coins per second
- ▶ Reliable through-hole coin disk design - no external wires run for level sensors
- ▶ ccTalk version available in encrypted and non-encrypted mode
- ▶ 12-24V power supply

# Evolution Hopper

## High Dispensing Speed and Reliability

Based on a belt drive, Evolution Hopper is the result of an entirely new design, which represents a decisive improvement in terms of both performance and ease of maintenance. The combination of extremely wear-resistant plastic resins with state-of-the-art electronics has produced a device with low purchase and management costs.

This type of hopper can be used for 95% of coins and tokens worldwide, without needing adjustments. Evolution Hopper is completely interchangeable with the other models available on the market. Suitable for many applications including Vending, Parking, Retail, and Amusement.



- ▶ Board easily accessible from outside and extractable for facilitating maintenance
- ▶ Equipped with a built-in agitator to prevent coin jams, as well as with additional electronic anti-jam electronics
- ▶ Interfaces: standard, parallel or ccTalk serial. The latter guarantees excellent security and diagnostics management
- ▶ DC motor, driven by an electronic actuator, which reduces friction and noise
- ▶ The standard version can be easily transformed into the adjoining version by simply removing the cover, which is fastened by two screws, and moving the connector to the new position
- ▶ High quality materials for long trouble-free operations



## UBA<sup>®</sup> Pro

The Next-Generation  
Bill Validator



The all-new JCM UBA<sup>®</sup> Pro sets new standards in automated transactions across the kiosk, retail, and gaming industries.

Meticulously designed for modern business environments, the UBA Pro's improved design delivers better performance including faster note-to-note acceptance, low cost of ownership and reduced service and repair downtime.

- ▶ Longer life-cycle
- ▶ Dust and liquid resistant design
- ▶ Faster note-to-note speed
- ▶ 2 or 4 way barcode reader
- ▶ Centering mechanism
- ▶ New, superior sensor package
- ▶ Best, patented anti-stringing technology
- ▶ Accepts the world's currencies
- ▶ Service-friendly modular design

## SC Advance<sup>®</sup>

Advanced Note Acceptor  
Performance



MEI's SC Advance advanced recognition technology, great speed and the increased capacity to accept up to 100 different currencies and denominations make it the best choice in the market.

- ▶ High acceptance rate: 98% or greater
- ▶ New note transportation system
- ▶ Notes insertion: up to 100 notes, 4-way face up and down
- ▶ Cash-box constructed of a durable, high-impact plastic with a welded design
- ▶ Traffic light LEDs provide front-line at machine diagnostics
- ▶ Robust design for a better durability
- ▶ Easily updates through interface cards
- ▶ New recognition system
- ▶ Interfaces: multiple serial protocols and USB
- ▶ Flexibility in mounting options

## NV200

Exceptional Note Handling on  
Banknotes up to 85mm Wide



The NV200 is a secure, field-proven banknote validator. With a lockable, removable cashbox that can hold up to 1000 notes, it is ideal for global high-volume applications. The unit can accept notes at acute angles in all four ways as auto-centering technology straightens notes before reading.

- ▶ Takes more cash
- ▶ Lowest cost of ownership
- ▶ Future proof – quick & easy updates via USB, data flash card, PC, or handheld programmer
- ▶ Reduces operator collection costs
- ▶ Superior note handling – maximizes cash efficiency
- ▶ One product suitable for most global applications

# Bill-to-Bill™

## Intelligent Cash Recycling



Bill-to-Bill™ “true” modular design enables field upgrades and allows customers to pay for what they “use”

**To Upgrade to Next Variant**  
 + Recycling Cassette  
 + Software Update



Experience the unparalleled excellence of our Bill-to-Bill™ - trusted by over 45,000 businesses worldwide. Elevate your change machine to new heights with the most outstanding and high-performing banknote recycler in the market.

- ▶ Design Scalability
- ▶ Field Proven Reliability
- ▶ Higher Dispensing Capacity
- ▶ Outstanding Product Design
- ▶ Low Jam Rate (MCBJ 1:20,000)
- ▶ Full Remote Control  
*NDEG licence (optional) to remotely update firmware and datasets*
- ▶ Certified European Central Bank

# Scratch Ticket Dispensers

## Instant Lottery Ticket Dispenser ccTalk Interface



To properly dispense the perforated lottery ticket, the exact ticket length must be set in the dispenser. You can predefine the exact length (mm) of the ticket and regulate the frequency of ticket cuts.

The dispenser has four length parameters in its NVRAM (from 1 to 4). Each parameter holds one length in mm. This length can vary from 10 to 300 mm.

Only one parameter length at a time is selected and active. This selection is held in NVRAM. The ccTalk HEADER 255 is used to read and set these parameters.

# ASSA®

## Desmo Casino Locks



The Assa Desmo is a patented lock construction based on direct drive pins (no spring operation) making it particularly suitable for many operations in dirty and hostile environments. False cuts on the pins provide resistance to any currently known method of picking.

- 8-pin lock combined with two strong side bars
- Large key made of nickel silver for lasting durability and comfortable operation
- Standard 90 degrees operation and key removable in locked position
- Various collars available to adjust any mounting depth
- Standard supplied with 32 mm cam, other sizes and models available
- Key-different locks are supplied with 2 keys per lock

# VENIA®

## Locks & Keys

### Venia Security Switchlocks DPST

- 14 pin system, 10 pins on the flat key side and 2 side pins on each side
- Brass housing with high quality spindle and bright chrome finish
- A security collar is included with every Venia lock to prevent any attempts to turn the lock with tools
- Key made of nickel silver assures longer lifetime and trouble-free operation
- Only available as key different
- Connection by 4 solder terminals
- 2 different switch configurations: pos. 1-3 on/off, pos. 2-4 off/on



### Venia Security Switchlocks

- 14 pin system, 10 pins on the flat key side and 2 side pins on each side
- Brass housing with high quality spindle and bright chrome finish
- A security collar is included with every Venia lock to prevent any attempts to turn the lock with tools
- Key made of nickel silver assures longer lifetime and trouble-free operation
- Venia switchlocks are available with and without automatic key return



### Venia Security Camlocks

- 14pin system, 10 pins on the flat key side and 2 side pins on each side
- Brass housing with high quality spindle and bright chrome finish
- A security collar is included with every Venia lock to prevent any attempts to turn the lock with tools
- Key made of nickel silver assures longer lifetime and trouble-free operation
- Camlocks are available in 3 different lengths: 16 mm (5/8"), 22.3 mm (7/8") and 28.6 mm (1-1/8")
- Standard 2 position 32 mm cam included



### Venia Keys

- Venia keys can only be ordered through SUZOHAPP
- Key made of nickel silver assures longer lifetime and trouble-free operation
- These keys can be cut to your specific key code







MONITORS



PRINTERS & SCANNERS



PCs



CLEANING SUPPLIES

We supply a complete range of component replacements and upgrades for all types of games and operations



BANKNOTE VALIDATORS & RECYCLERS



LOCK SETS (TRANSPORT OR HIGH-SECURITY)



TITO TICKETS & PRINTER ROLLS



**SUZOHAPP America**

601 Dempster Street,  
Mount Prospect, IL 60056  
Toll Free: +1 888-289-4277  
info@suzohapp.com

**SUZOHAPP America**

1385 Pama Lane Unit 100,  
Las Vegas, NV 89119  
Toll Free: +1 888-289-4277  
info@suzohapp.com

**SUZOHAPP Netherlands B.V.**

Laurens Jzn. Costerstraat 13c,  
3261 LH Oud-Beijerland  
The Netherlands  
Phone: +31 (0)613-847-313  
sales.eu@suzohapp.com

**SUZOHAPP UK Ltd**

Unit D2 Longmead Business Park,  
Felstead Rd, Epsom, Surrey - KT19 9QG,  
United Kingdom  
Phone: (+44) 208-391-7700  
sales.uk@suzohapp.com

**SUZOHAPP Polska Sp. z o.o**

Składowa 1B, Koninko  
62-023 Gądko k. Poznań  
Phone: +48 61 271 6060  
sales.eu@suzohapp.com

**SUZOHAPP Asia Limited, Macau**

Avenida Venceslau de Morais no. 157  
Kek Seng Industrial Building,  
Phase 2, 2nd Floor-L, Macau  
Phone: +853 2895 6289  
sales.asia.mo@suzohapp.com

© 2023 SUZOHAPP All rights reserved. Specifications subject to change.

Trademarks owned by their respective holders.

No part of this catalogue may be reproduced in any form by print, photoprint or any other means, without written permission from the publisher. Technical data, text and pictures are subject to error and modifications. The catalogue can be subject to further developments.