

Rev	AMEND	DATE	CHECK	APPR.
P1	Proto	2019.12.13	H.I.Woo	H.Y.Sohn
P2	Changed Glass Monitor Wall Mount Hole M6 300mm x 200mm	2019.12.17	H.I.Woo	H.Y.Sohn
P3				
P4				

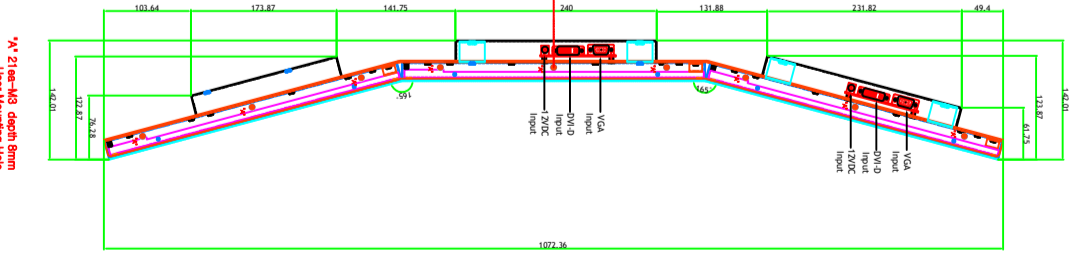
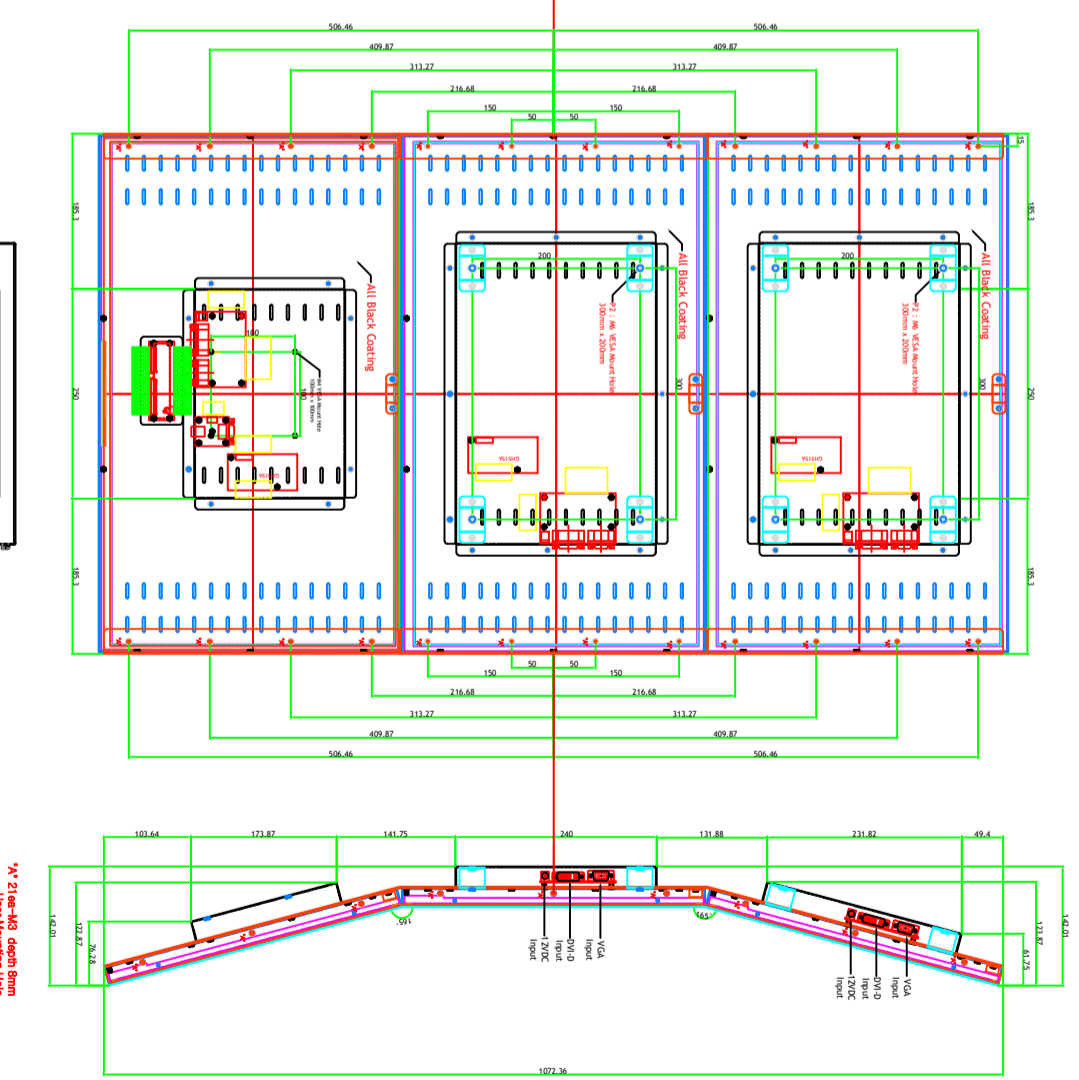
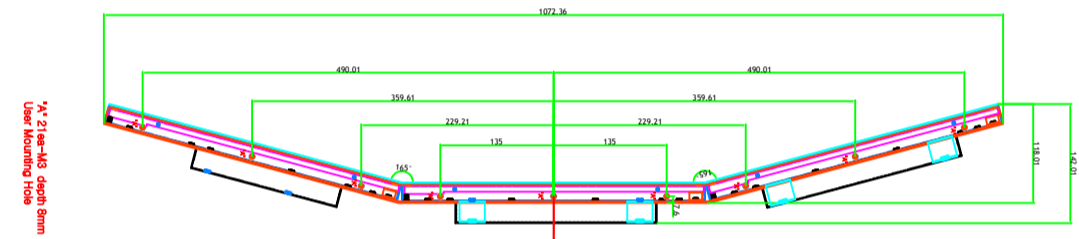
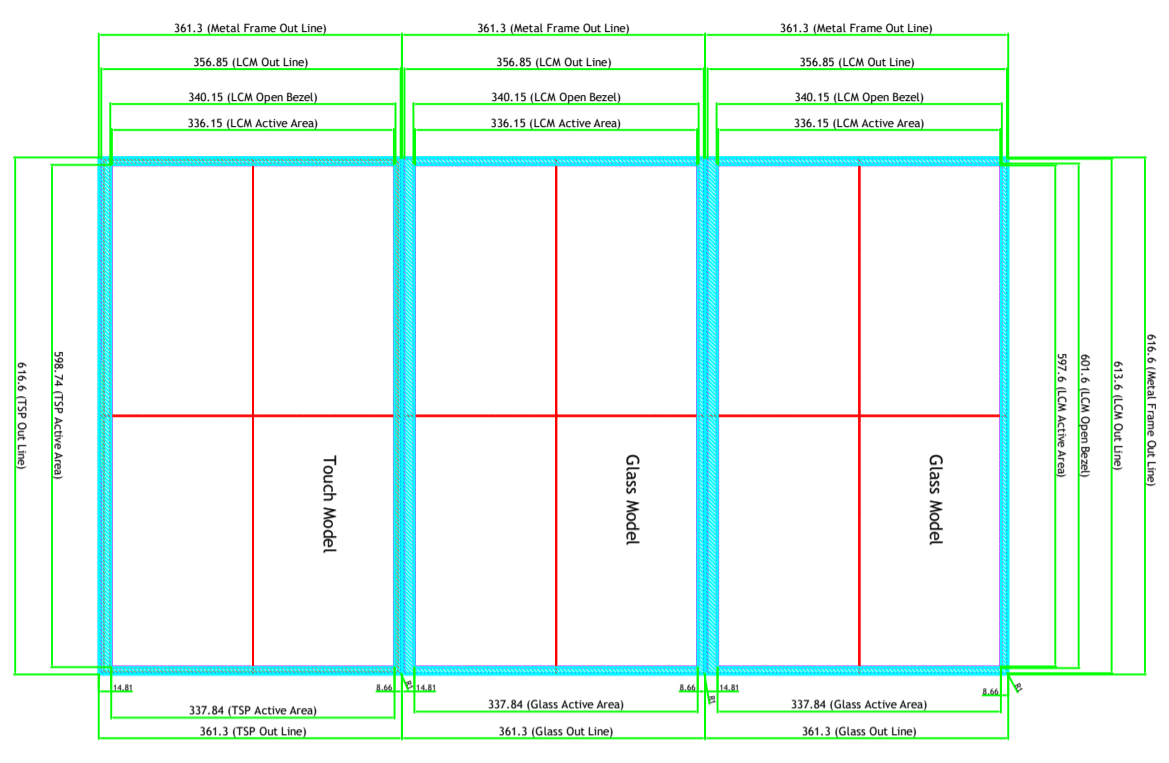
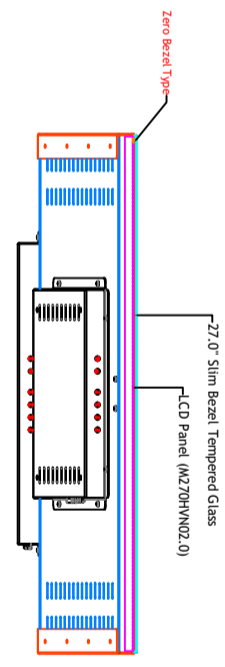

27.0" Triple Curved Monitor

Main Frame EGI = 1.0T Black Coating
Rear Cover EGI = 1.0T Black Coating

		MODEL NO	INC-2703FHPNTPC-U	VIEW :		UNIT : mm
		NAME	27" Closed Frame	Qty	1	REV.
DRAWN	CHECKED	APPROVED	DWG. NO	SCALE	1 / 1	
H.I.Woo		H.Y.Sohn	4M2703058-00	DATE	2019.12.17	
MATERIAL / FINISH		EG1 T=1.0				

Rev	AMEND	DATE	CHECK	APPR.
P1	Proto	2019.08.13	H.I.Woo	H.Y.Sohn
P2	Added Triple Monitor Mounting Hole	2019.12.13	H.I.Woo	H.Y.Sohn
P3				

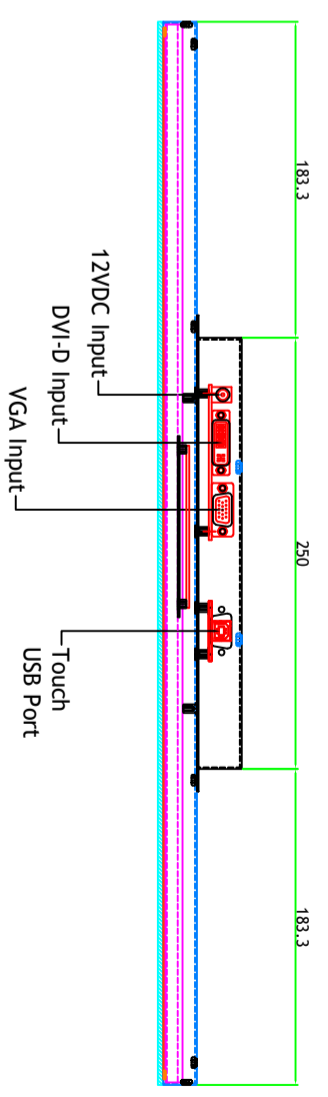
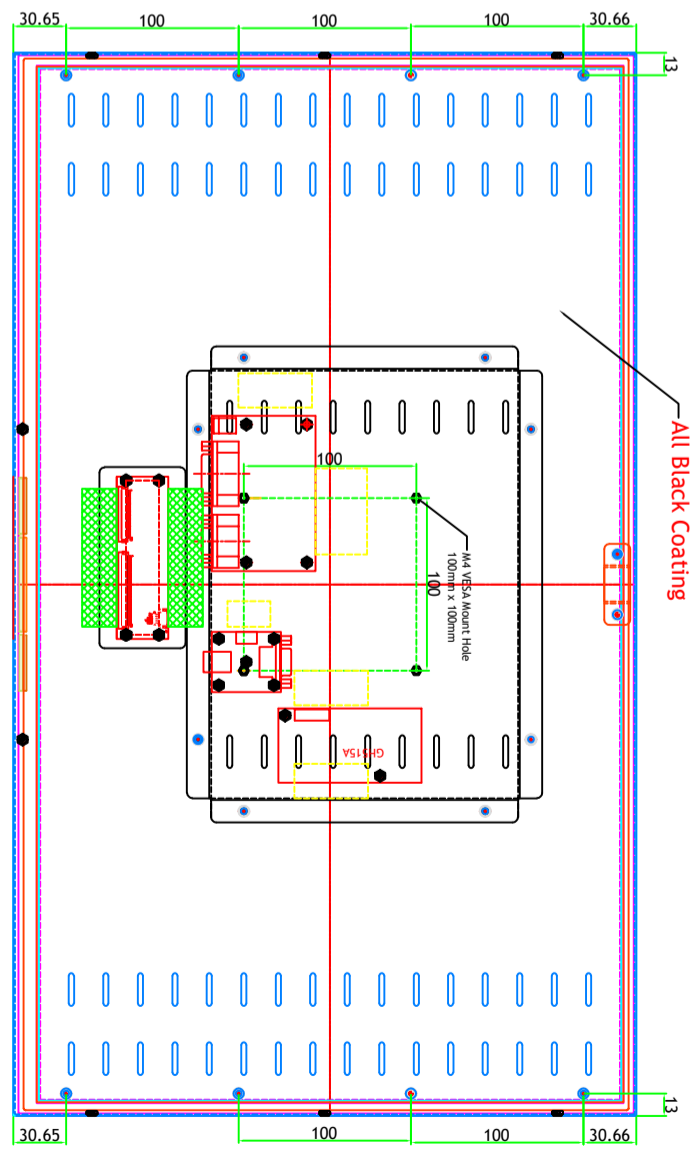
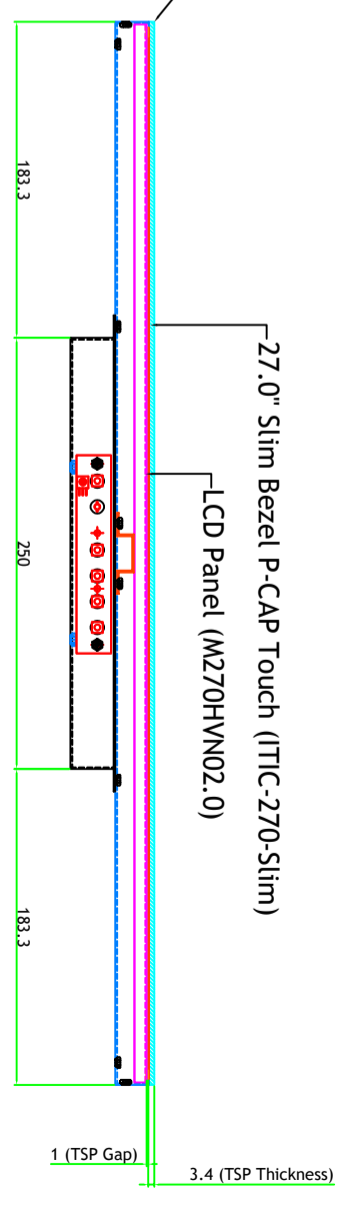
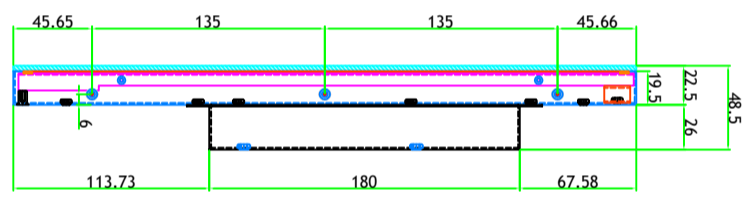
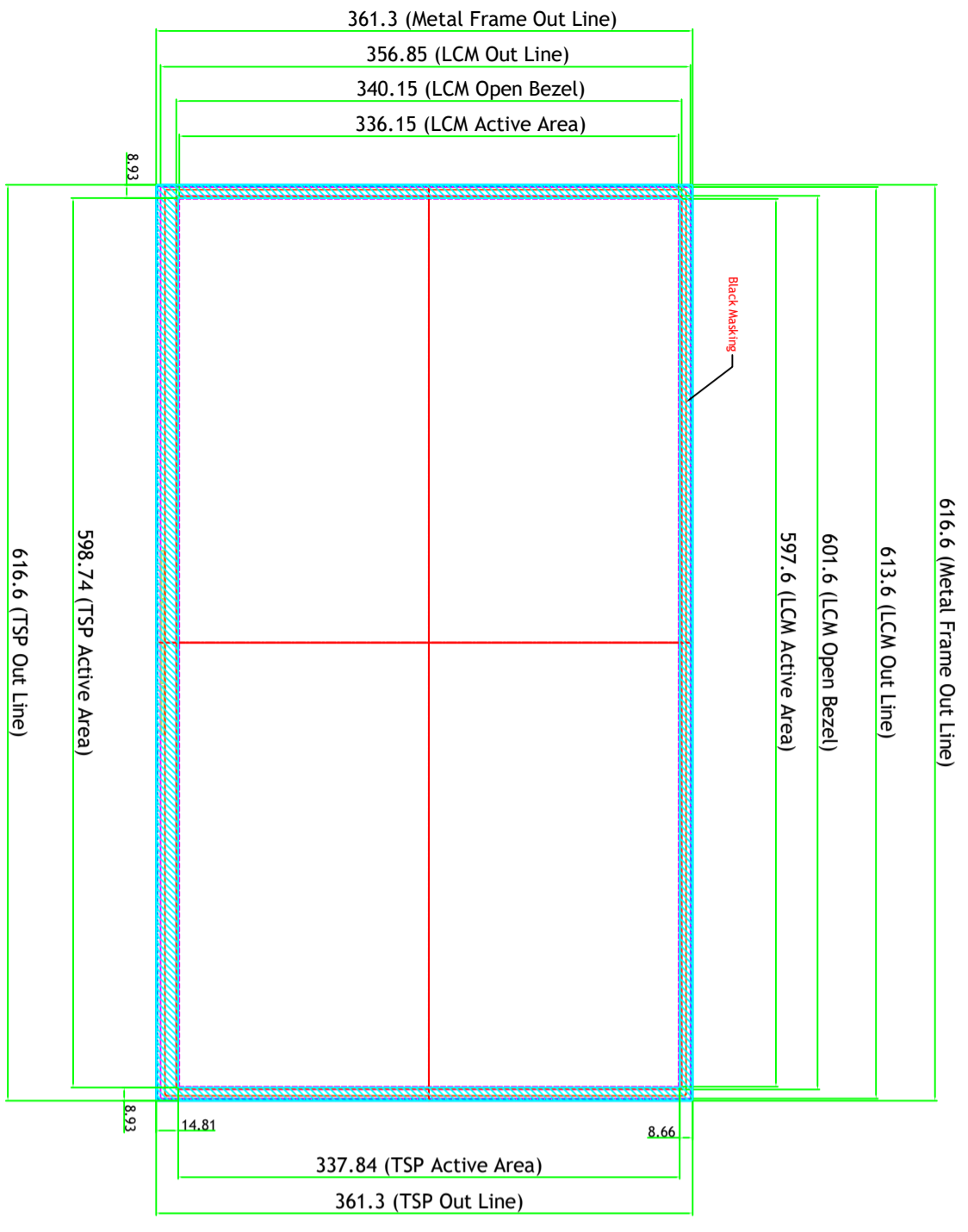

		MODEL NO	INC-2703FHPNIPC-U		VIEW :			UNIT :	mm	
		NAME	27.0" Closed Frame		Qty	1		REV.	P2	
DRAWN	CHECKED	APPROVED	DWG. NO	4M2703046-01		SCALE	1 / 1			
H.I.Woo		H.Y.Sohn	MATERIAL / FINISH	EGI T=1.0		DATE	2019.12.17			

Rev	AMEND	DATE	CHECK	APPR.
P1	Proto	2019.08.13	H.I.Woo	H.Y.Sohn
P2	Added Triple Monitor Mounting Hole	2019.12.13	H.I.Woo	H.Y.Sohn
P3				

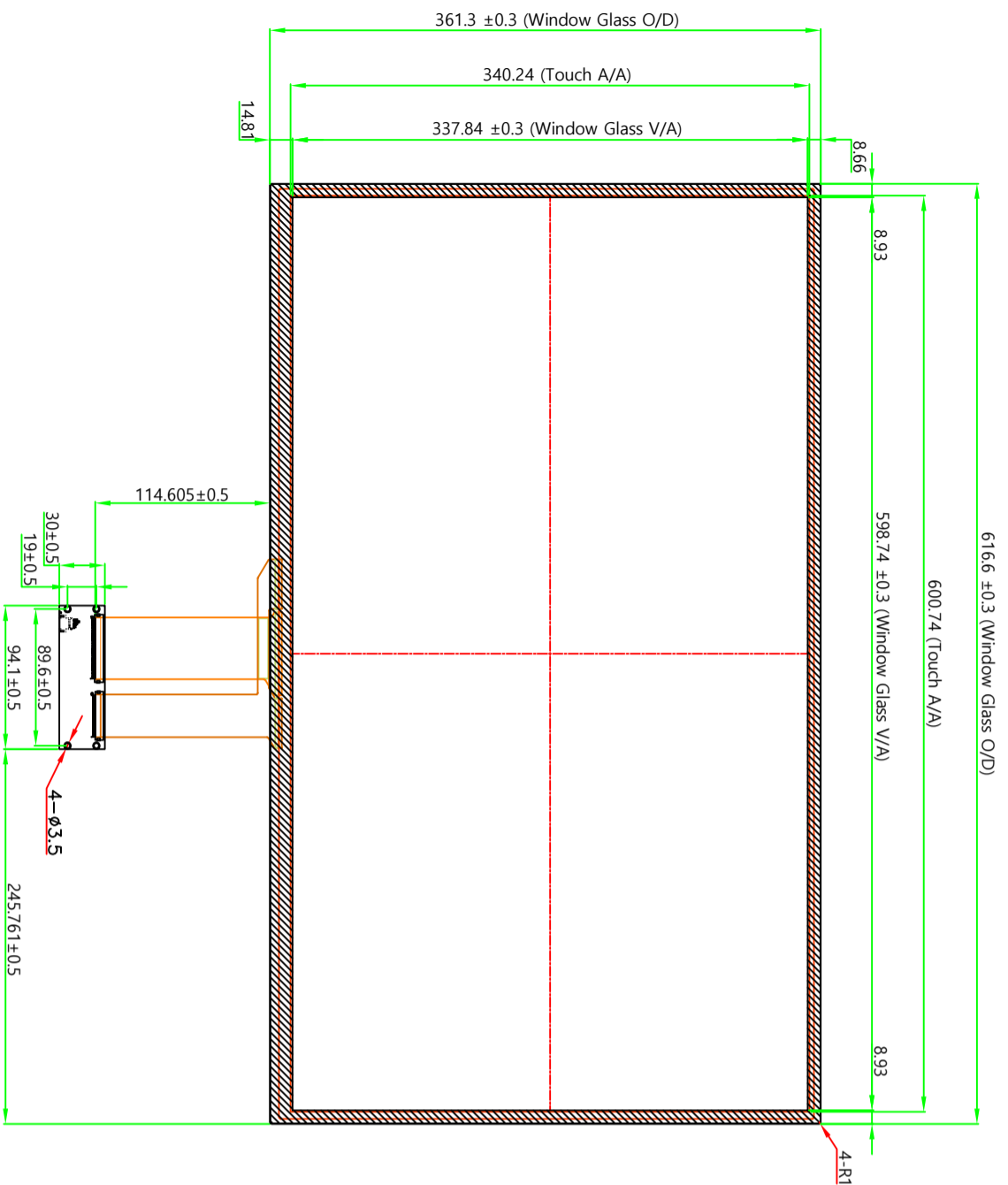
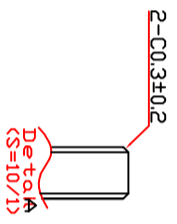

- TOP VIEW (Touch Module) -

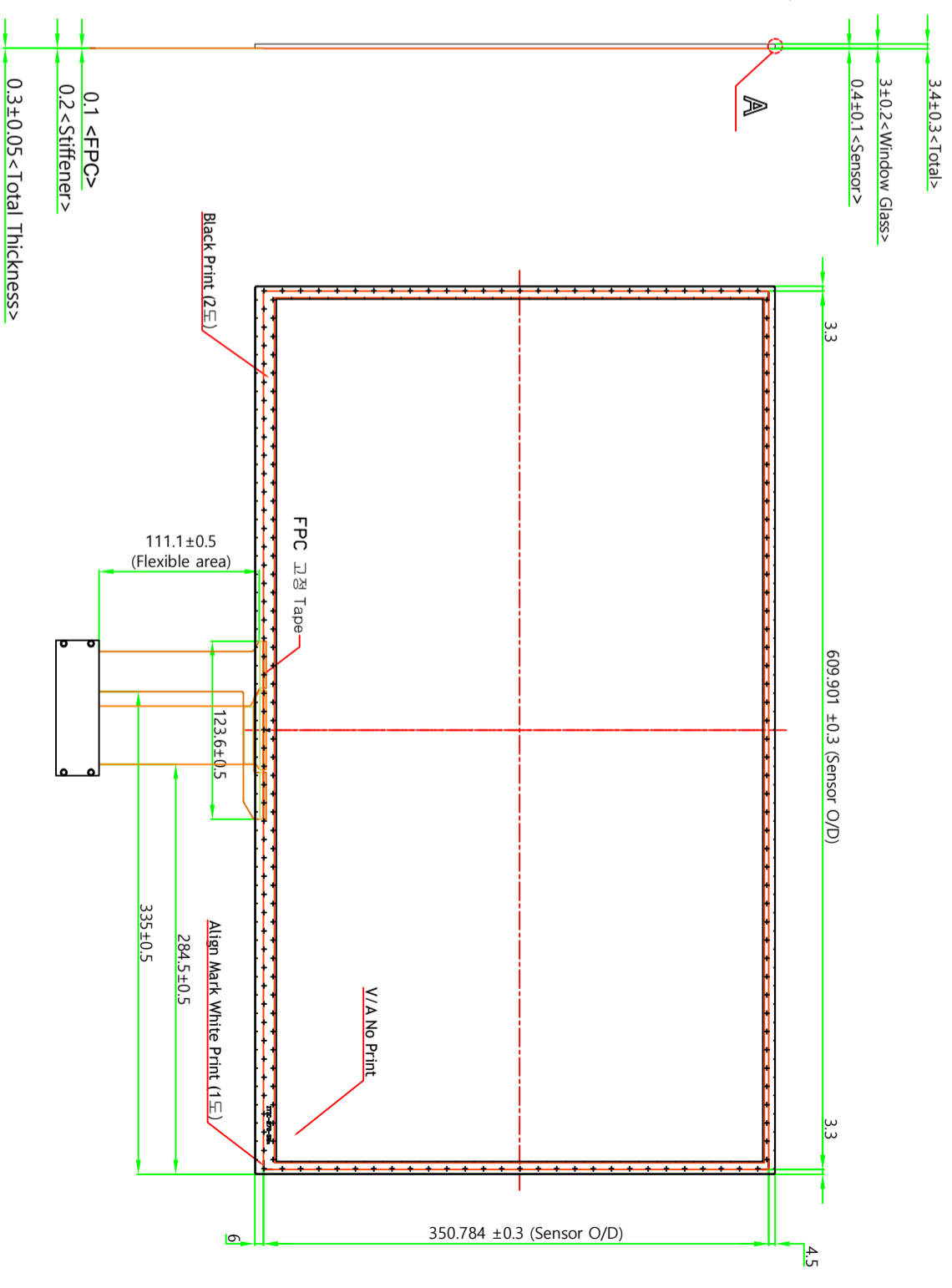

- RIGHT VIEW -

- BOT VIEW -

NOTES

1. Type: GFF Capacitive Touch Panel
2. Cover Window: Tempered Soda Lime 3.0T
3. Touch Performance: 10 Point, 15 ϕ
4. Interface : USB
5. Window Decoration Color : Black Color Printing
6. Transmittance : 88%±3%
7. Surface Hardness : More than 6H
8. Control Board : Silicon Works

STACK UP & MATERIAL

Description	Material	Thickness
Cover Window	Tempered Soda Lime	3000um
Top OCA	LGH, OC9102D	100um
Top Film	ITO Film	100um
Mid OCA	LGH, OC9102D	100um
Bot Film	ITO Film	100um

		MODEL NO	INC-2703FHPNPC-U	VIEW :		UNIT :	mm
		NAME	27.0" Closed Frame	Qty	1	REV.	P1
DRAWN	CHECKED	APPROVED	DWG. NO	4M2703046-01	SCALE	1 / 1	
H.I.Woo		H.Y.Sohn	MATERIAL / FINISH	EGI T=1.0	DATE	2019.12.17	

Rev	AMEND	DATE	CHECK	APPR.
P1	Proto	2019.12.13	H.I.Woo	H.Y.Sohn
P2	Changed Wall Mount Hole M6 300mm x 200mm	2019.12.17	H.I.Woo	H.Y.Sohn
P3				

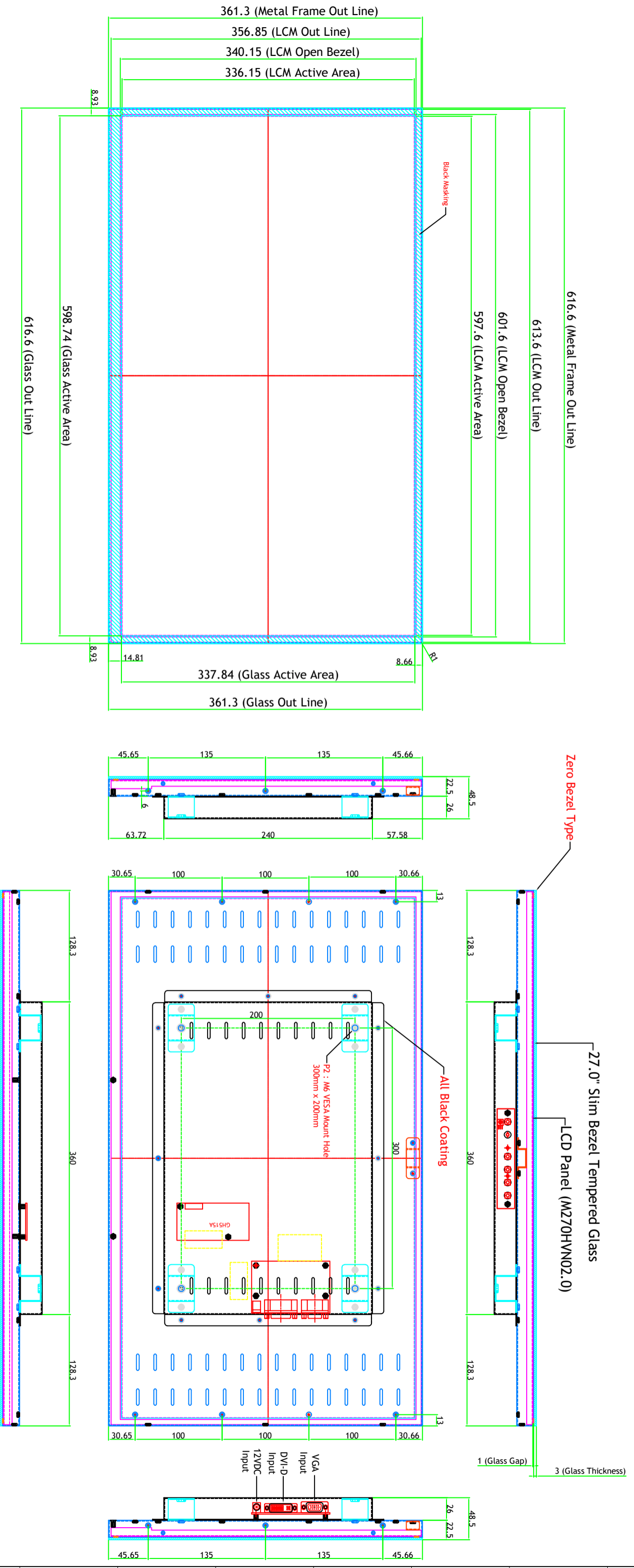

		MODEL NO	INC-2703FHPNIG	VIEW :		UNIT : mm
DRAWN	CHECKED	NAME	27.0" Closed Frame	Qty	1	REV.
H.I.Woo		DWG. NO	4M2703055-01	SCALE	1 / 1	P2
	APPROVED	MATERIAL / FINISH	EGI T=1.0	DATE	2019.12.17	
	H.Y.Sohn					

Rev	AMEND	DATE	CHECK	APPR.
P1	Proto	2019.12.13	H.I.Woo	H.Y.Sohn
P2				
P3				

Front View

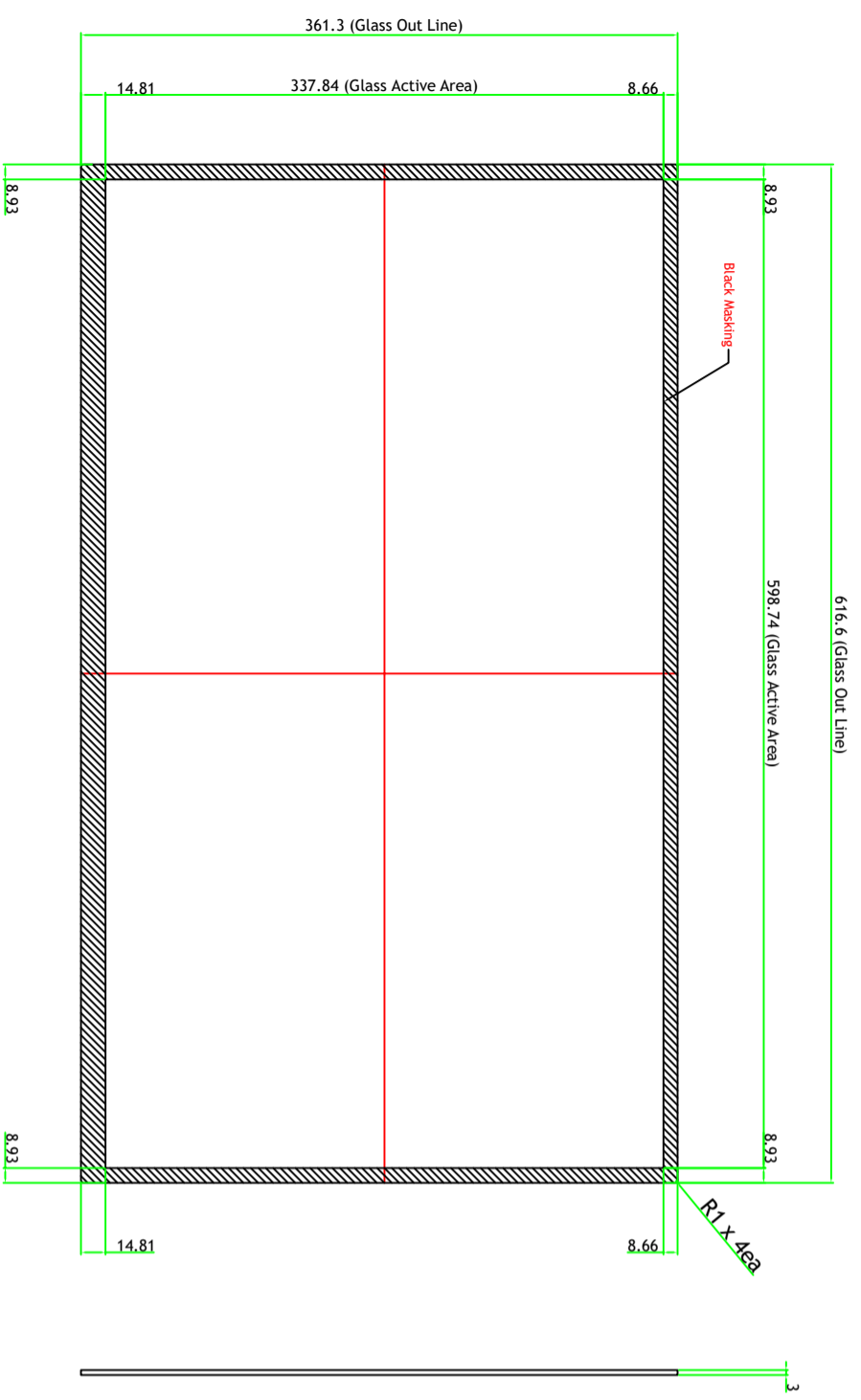

Rear View

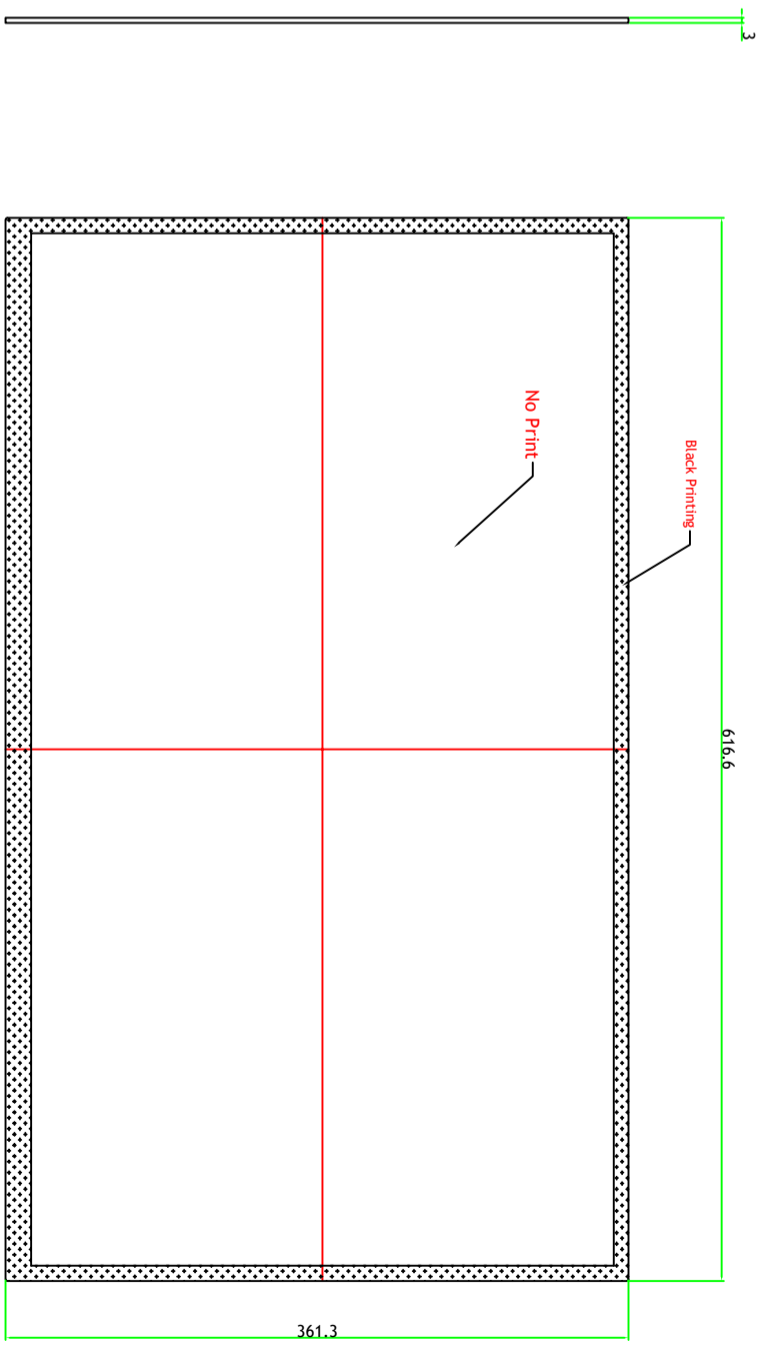

- Black Masking : 1 time

PGLSHT2703010 27.0" Slim Bezel Touch Glass Drawing
V1.0 2019.12.17

		MODEL NO	INC-2703FHPNIG	VIEW :	UNIT : mm
		NAME	27.0" Closed Frame	Qty	1
DRAWN	CHECKED	APPROVED	DWG. NO	SCALE	1 / 1
H.I.Woo		H.Y.Sohn	MATERIAL / FINISH	DATE	2019.12.17
			EGI T=1.0		

Rev	AMEND	DATE	CHECK	APPR.
P1	Proto	2019.12.12	H.I.Woo	H.Y.Sohn
P2				
P3				

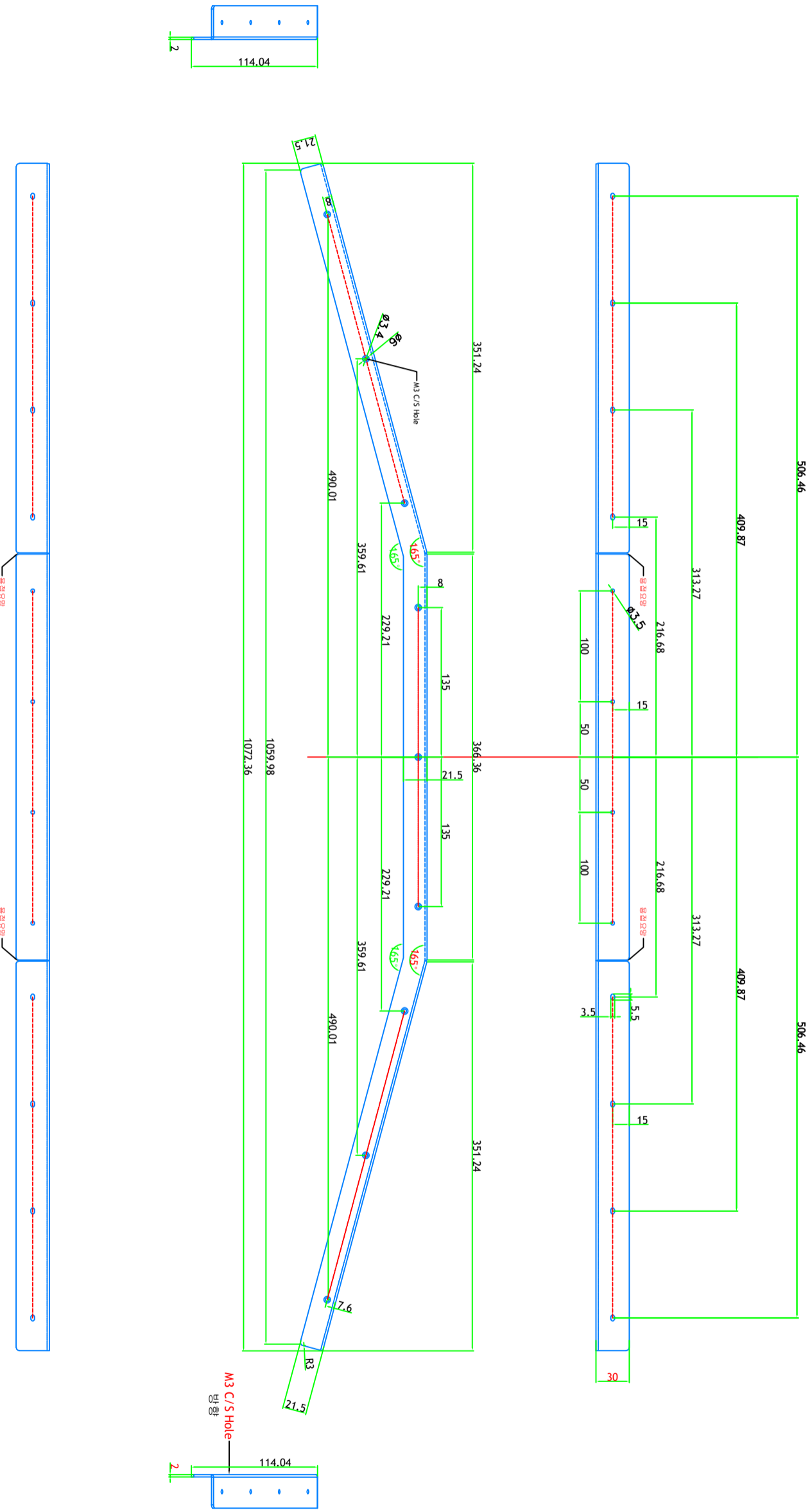

27.0" Triple Curved 고정 Bracket x 2ea
 EGI = 2.0T / Black Sandtone 도장

		MODEL NO	INC-2703FHPNTPC-U	VIEW :		UNIT : mm
		NAME	27.0" Closed Frame	Qty	1	REV.
DRAWN	CHECKED	APPROVED	DWG. NO	4M2703058-00	SCALE	1 / 1
H.I.Woo		H.Y.Sohn	MATERIAL / FINISH	EGI T=2.0	DATE	2019.12.17

1 2 3 4 5 6 7 8 9 10 11 12 13 14 15 16