

Rev	AMEND	DATE	CHECK	APPR.
P1	Proto	2017.12.07	H.I.Woo	H.Y.Sohn
P2	Changed Model Name INC-2153FHRNPC-U ---> 150LP2150	2018.01.02	H.I.Woo	H.Y.Sohn
P3	Changed Main Frame Size H : 545 ---> 542mm / V : 339.6 ---> 336.6mm	2018.02.01	H.I.Woo	H.Y.Sohn
P4	Changed Frame Total thickness 57.3mm ---> 51.0mm	2018.05.10	H.I.Woo	H.Y.Sohn
P5	Changed I/O Port Name RGB Input ---> VGA Input	2019.05.28	H.I.Woo	H.Y.Sohn

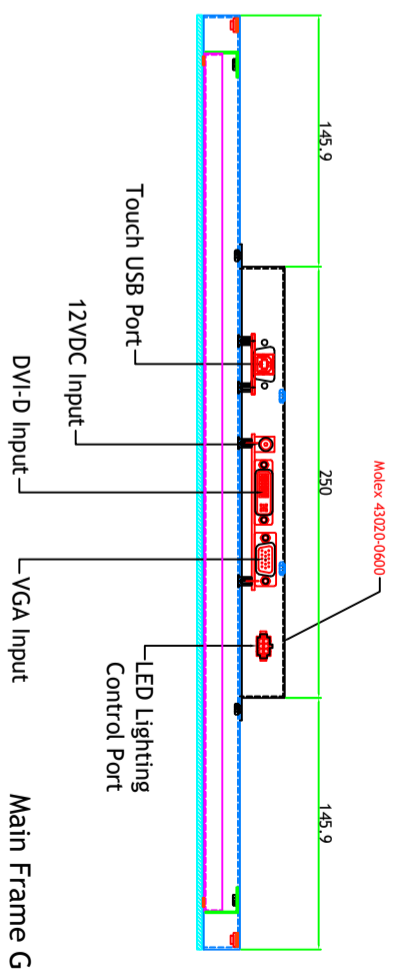
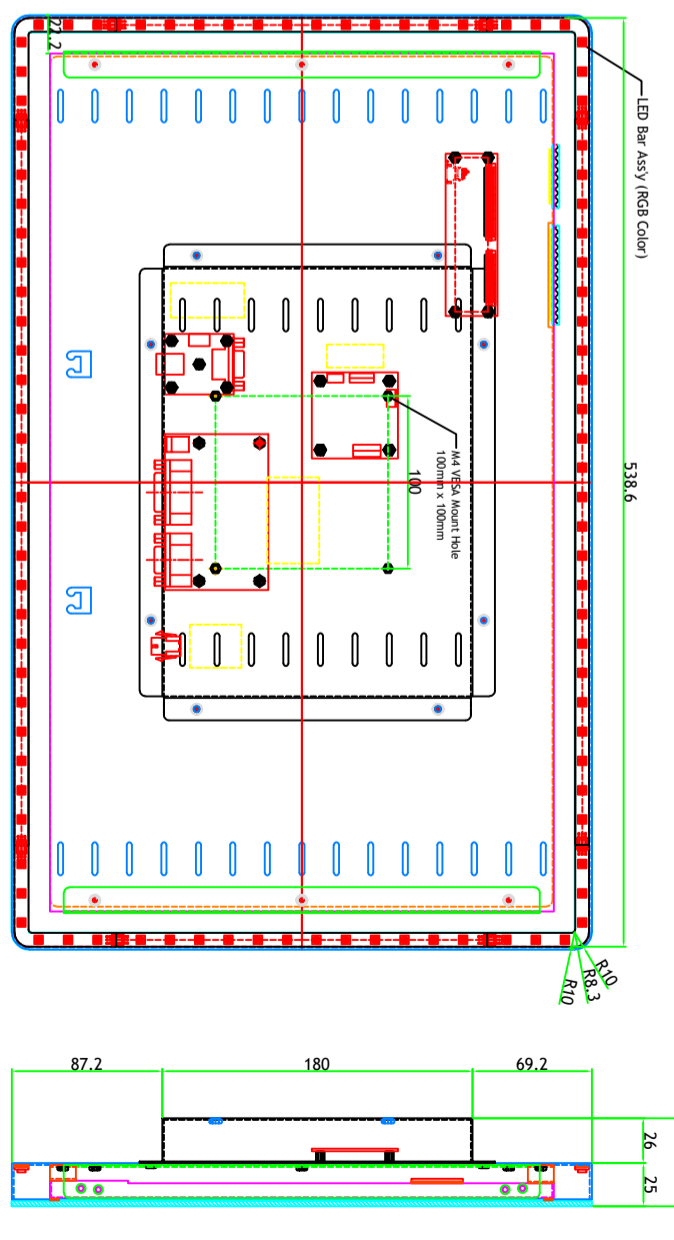
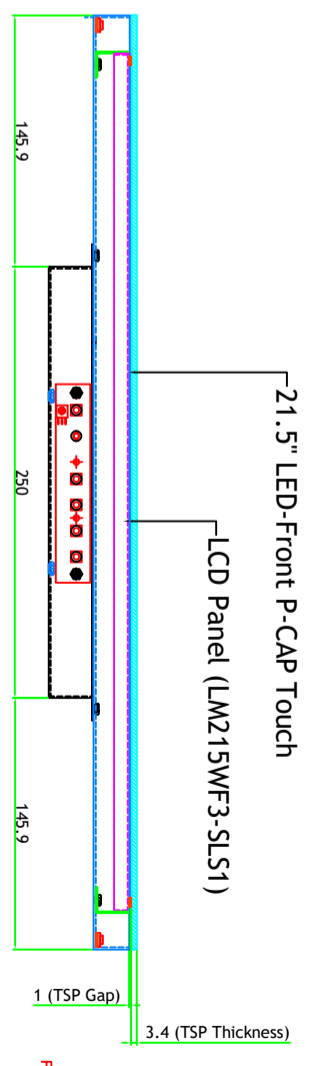
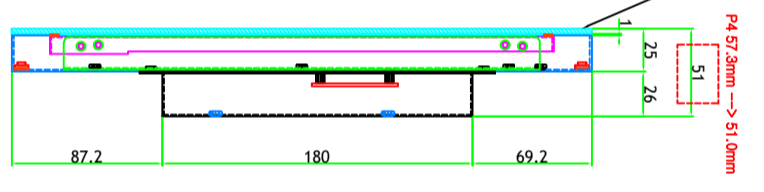
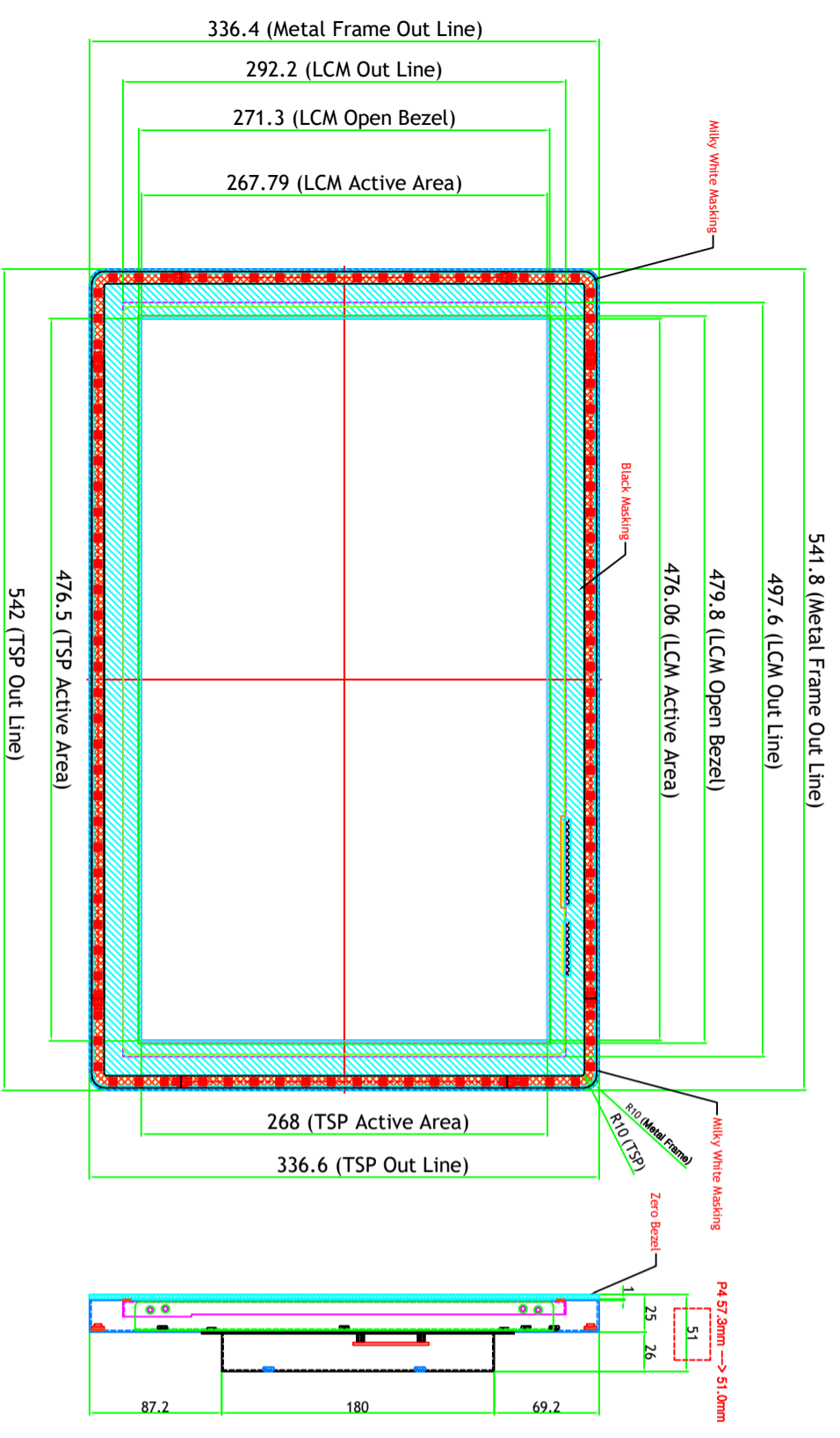

Main Frame GI = 1.2T Black Coating
Rear Cover GI = 1.0T Black Coating

LED Lighting Control Port Pin Map (w/o IC)

#1 : Red , #2 : Green , #3 : Blue
#4 : VCC 12V , #5 : GND , #6 NC

Molex 43020-0600

		MODEL NO	150LP2150		VIEW :			UNIT :	mm	
		NAME	21.5" Closed Frame		Qty	1		REV.	P5	
DRAWN	CHECKED	APPROVED	DWG. NO	4M2153053-04		SCALE	1 / 1			
H.I.Woo		H.Y.Sohn		MATERIAL / FINISH	EGI T=1.2		DATE	2019.05.28		

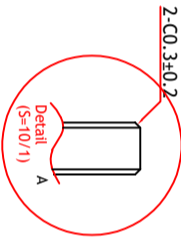

Rev	AMEND	DATE	CHECK	APPR.
P1	Proto	2017.12.07	H.I.Woo	H.Y.Sohn
P2	Changed Model Name INC-2153FHRNPC-U ----> 150LP2150	2018.01.02	H.I.Woo	H.Y.Sohn
P3	Changed Main Frame Size H : 545 --> 542mm / V : 339.6 --> 336.6mm	2018.02.01	H.I.Woo	H.Y.Sohn
P4	Changed Frame Total thickness 57.3mm --> 51.0mm	2018.05.10	H.I.Woo	H.Y.Sohn
P5	Changed I/O Port Name RGB Input ----> VGA Input	2019.05.28	H.I.Woo	H.Y.Sohn

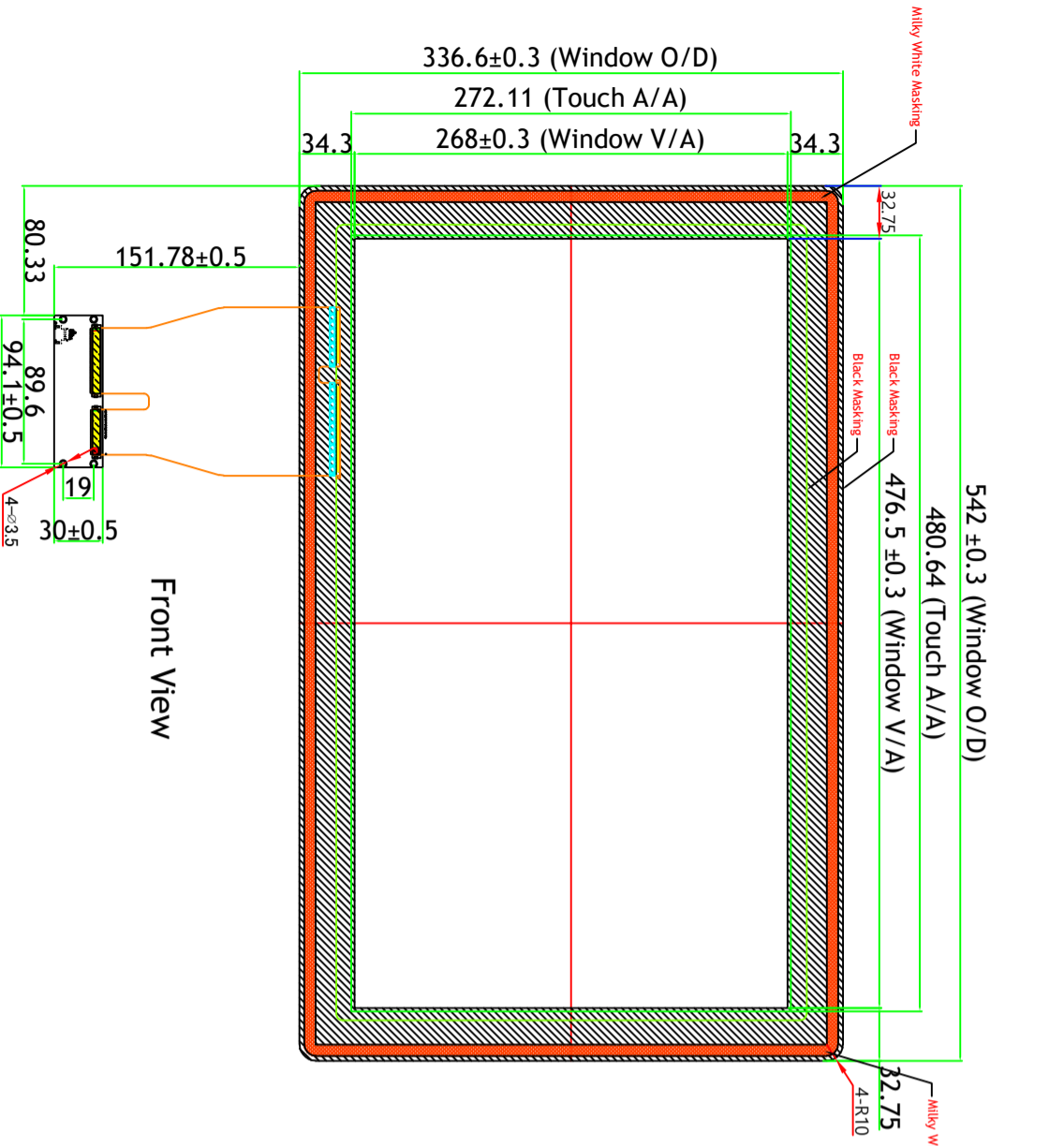

Front View

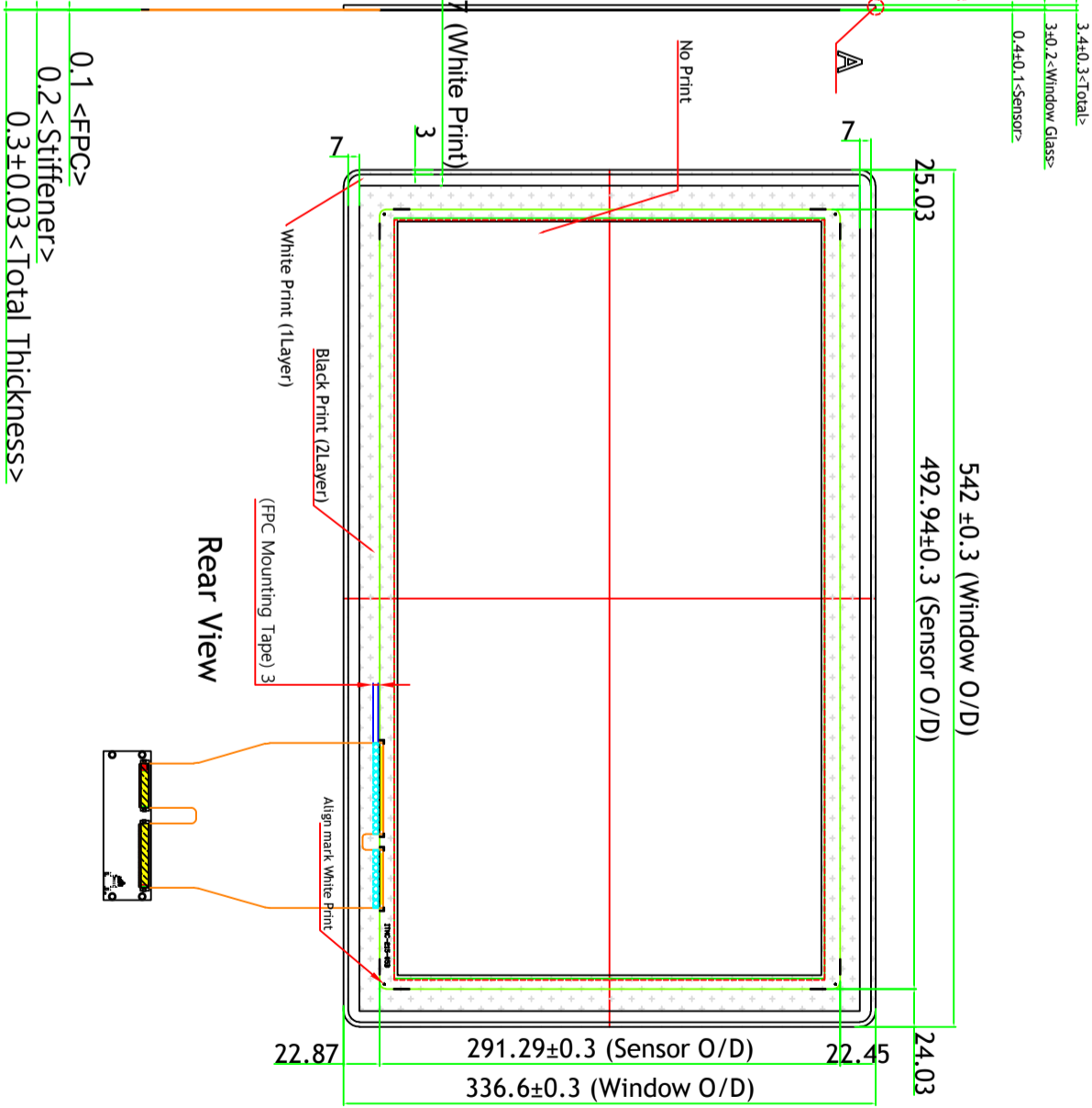

Rear View

- Black Masking : 2 time
- Milky White Masking : 2time
- Touch Align Mark : 1 time

21.5" LED-Front Lighting Model Touch Glass Drawing

NOTES

1. Type : GFF Type Capacitive Touch Panel
2. Touch Performance : 10Point, ø8
3. Interface : USB
4. Window Glass : Tempered Soda Lime 3T
5. Window Decoration Color : Black Color Printing
6. Transmittance : 85% ±3%
7. Surface Hardness : More than 6H
8. Control Board : Silicon Works
9. Sensor Material : Metal mesh

STACK UP & MATERIAL

Description	Material	Thickness
Cover	Window/Glass	3mm
Top DCA	LGH, DC9102D	100um
Top Film	Metal Mesh Film	100um
Mid DCA	LGH, DC9102D	100um
Bot Film	Metal Mesh Film	100um
Total Thickness - 3400um		

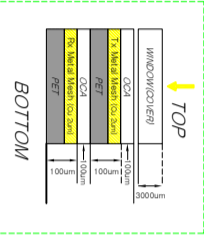

		MODEL NO	150LP2150		VIEW :			UNIT :	mm	
		NAME	21.5" Closed Frame		Qty	1		REV.	P5	
DRAWN	CHECKED	APPROVED	DWG. NO	4M2153053-04	SCALE	1 / 1		DATE	2019.05.28	
H.I.Woo		H.Y.Sohn		MATERIAL / FINISH	EGI T=1.2					