

Rev	AMEND	DATE	CHECK	APPR.
P1	Proto	2019.09.02	H.I.Woo	H.Y.Sohn
P2				
P3				

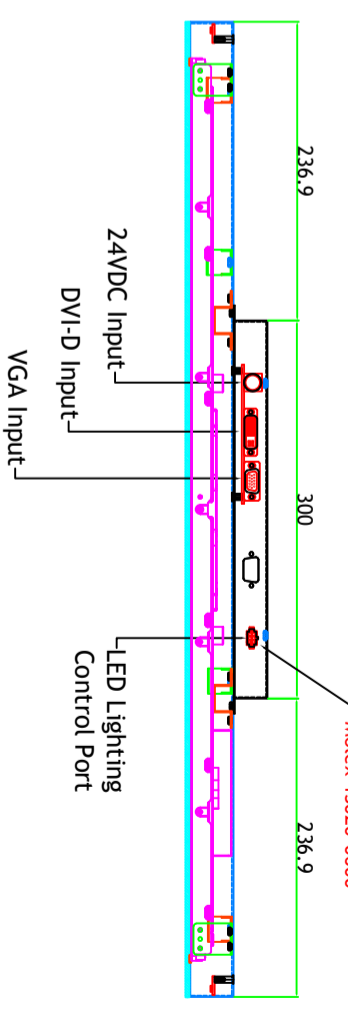
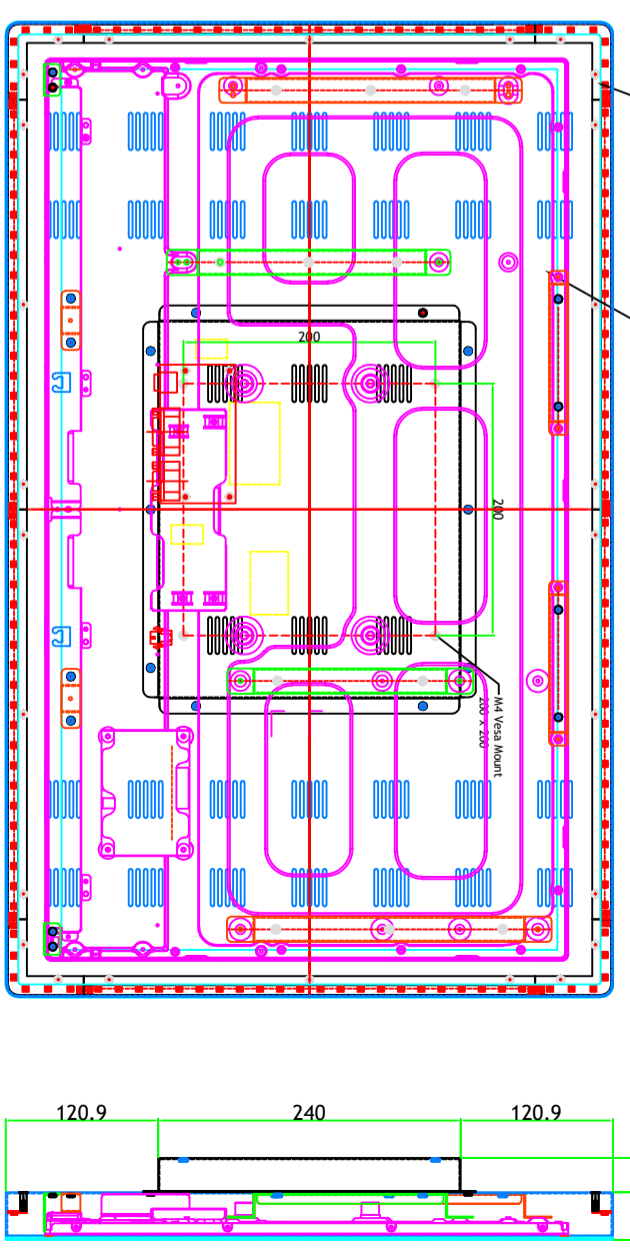
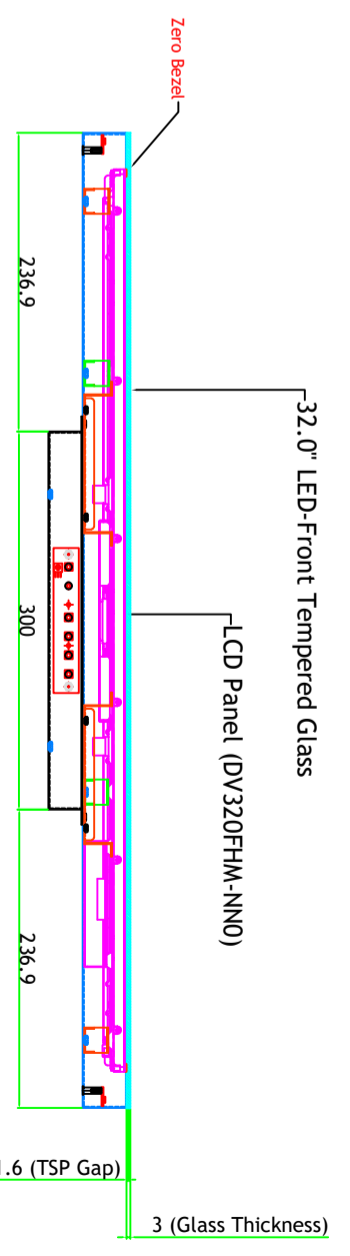
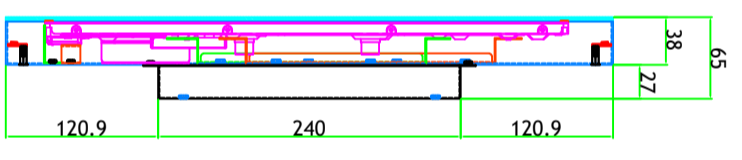
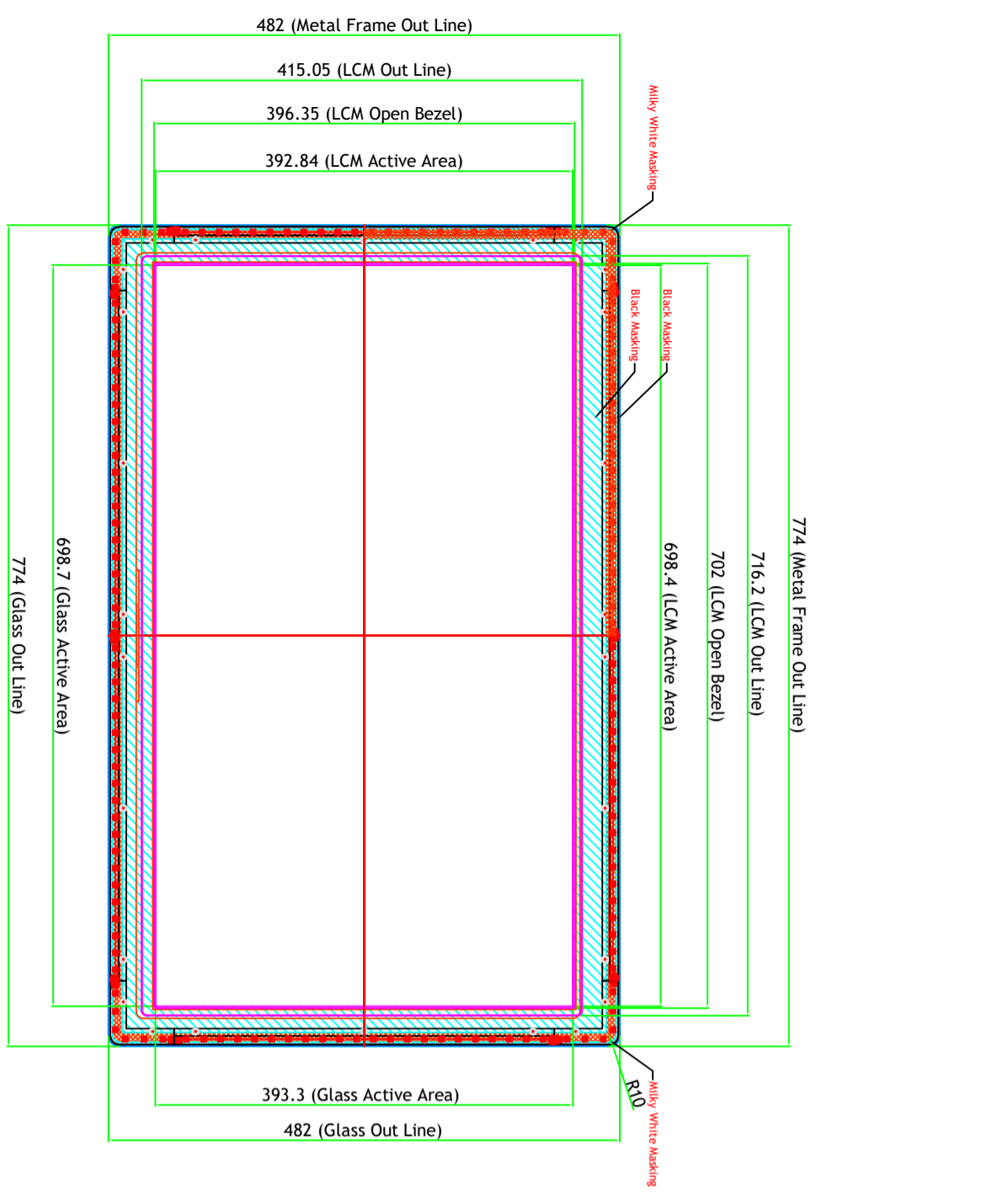

LED Lighting Control Port Pin Map (w/ IC)

#1 : 5V, #2 : CTL, #3 : GND
 #4 : 5V, #5 : NC, #6 : GND

Molex 43020-0600

SUZOHAPP		MODEL NO	150LG3202		VIEW	UNIT : mm
DRAWN	CHECKED	NAME	32" Closed Frame	QTY	1	REV. P1
H.I.Woo	H.Y.Sohn	DWG. NO	4M3203044-00	SCALE	1 / 1	DATE
		MATERIAL / FINISH	EGI T=1.2			2019.09.02

Main Frame GI = 1.2T Black Coating
 Rear Cover GI = 1.0T Black Coating

Rev	AMEND	DATE	CHECK	APPR.
P1	Proto	2019.09.02	H.I.Woo	H.Y.Sohn
P2				
P3				

Front View

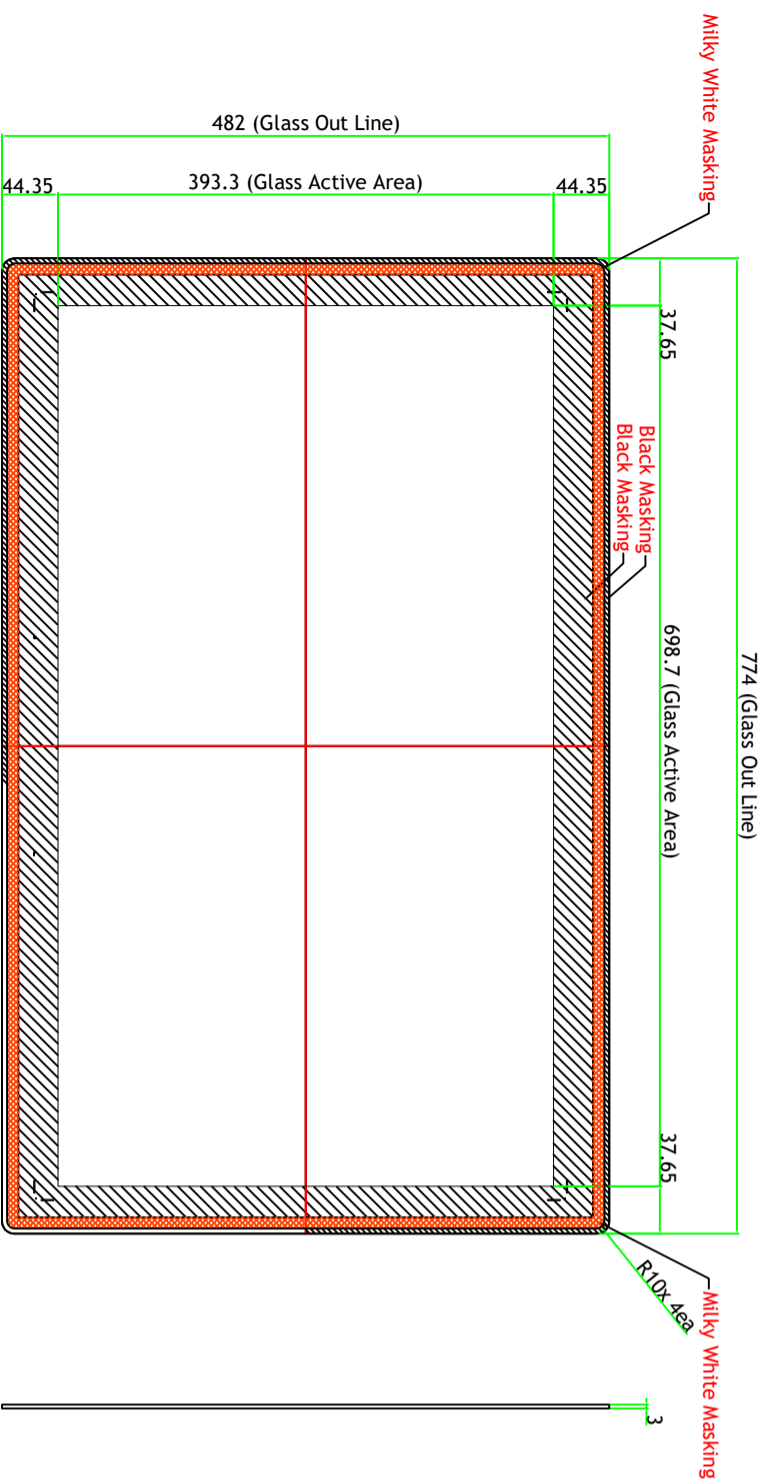

Rear View

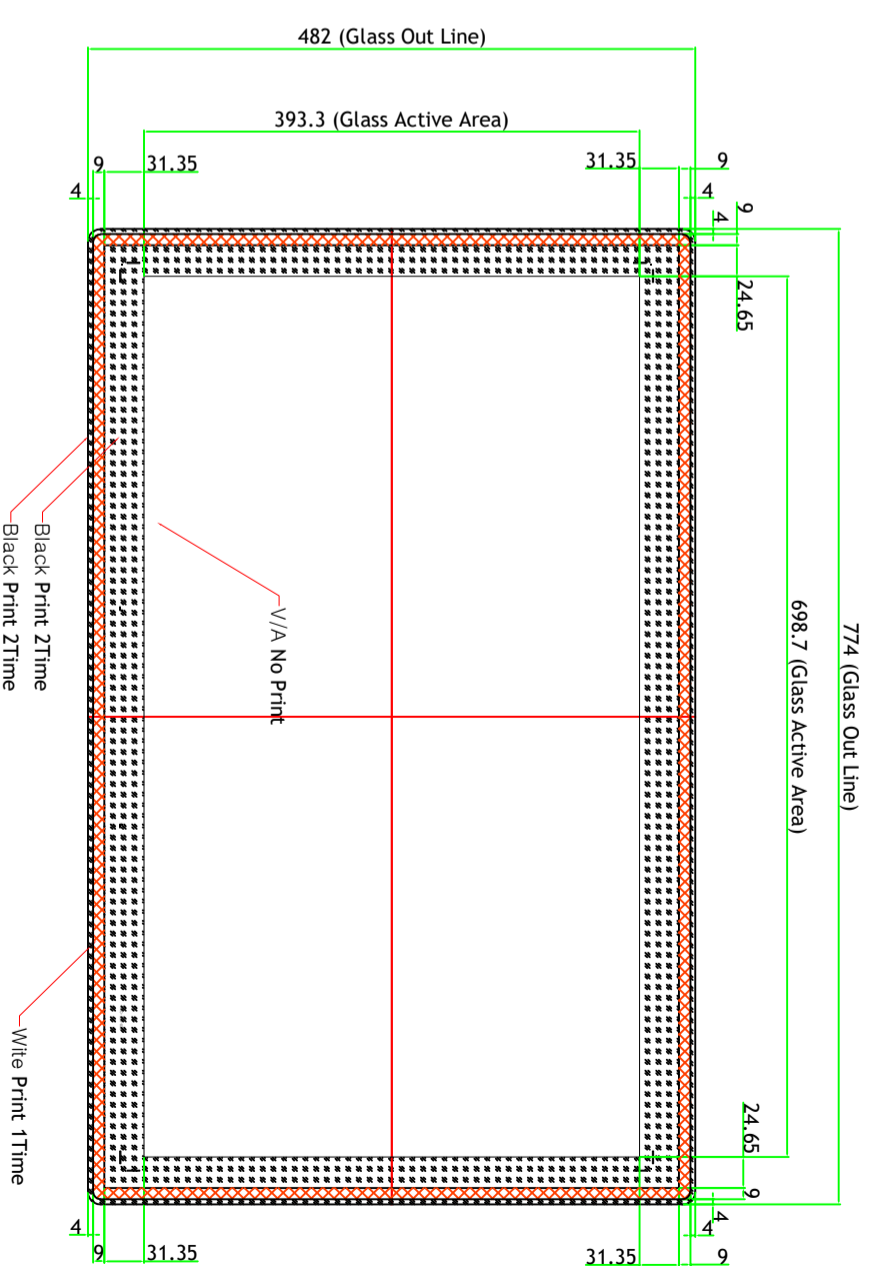

- Black Masking : 2time
- Milky White : 1time
- Touch Align Masking : 1time

PGLSHT3203001 32.0" LED-Front Model Glass Drawing

		MODEL NO	150LG3202		VIEW :			UNIT :	mm	
		NAME	32" Closed Frame		Qty	1		REV.	P1	
DRAWN	CHECKED	APPROVED	DWG. NO	4M3203044-00		SCALE	1 / 1			
H.I.Woo		H.Y.Sohn	MATERIAL / FINISH	EGI T=1.2		DATE	2019.09.02			