

MODEL : 150LG3200

Zero Bezel with Printed Tempered Glass
 LED Illumination on Front, 4 Sides
 12V RGB LEDs, w/o IC

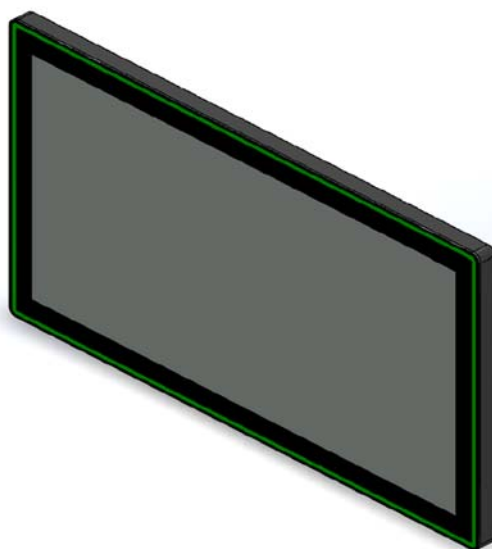

| Revision | Date | History |
|----------|------------|------------------|
| V0.1 | 2019.09.02 | Initial Release. |
| | | |
| | | |
| | | |
| | | |

Draft _____

Date : _____

Checked: _____

Date : _____

Approved : _____

Date : _____

Contents

1. General Description

- 1.1 Overview**
- 1.2 General Specifications**
- 1.3 Environmental and Reliability Specification**
- 1.4 Power Supply Rating**
- 1.5 Input/Output Port**

2. User Control & OSD

- 2.1 Key Control Board**
- 2.2 OSD Control Function**

3. Connector Description

- 3.1 Summary**
- 3.2 J6: 24VDC Power Input Connector**
- 3.3 J8: Auto Dimming/RS232 Connector**
- 3.4 J1: Backlight Inverter Connector**
- 3.5 J15: OSD Board Connector**
- 3.6 J2: 12VDC/5VDC External Output Connector**
- 3.7 J4: 24VDC Input Jack**
- 3.8 J11: DVI Input Connector**
- 3.9 J23: VGA Input Connector**
- 3.10 J14: LCD Interface Connector**

4. Standard Display Modes

5. LED Backlight Driver Board Specification

6. Board Dimensions

7. LED Lighting Control Specification

8. Packing Information

9. Mechanical Structure

1. General Description

1.1 Overview

- ◆ SUZOHAPP Closed-frame LCD Monitor 150LG3200 is a high performance TFT LCD monitor providing a high quality screen image.
- ◆ This monitor supports VGA and DVI input. Other input options are available.
- ◆ Wide input resolution range up to Full HD (1920 x 1080@60Hz).
- ◆ It is designed for industrial use with Auto power on, up scaling performance adequate for low-resolution applications and enhanced design margin for reliability.
- ◆ It is available in matching touch and non-touch designs.

1.2 General Specifications

| | | |
|-------------------------|-------------------------------------|--|
| LCD Panel | Size | 31.5" Diagonal |
| | Active Display Area | 698.4(H) x 392.85(V)mm |
| | Type No. | BOE DV320FHM-NN0 |
| | Number of Pixels | 1920 (H) x 1080 (V) |
| | Pixel Arrangement | RGB Vertical Stripe |
| | Pixel Pitch | 0.36375mm x 0.36375mm |
| | Color Depth | 16.7M True Colors |
| | Surface Treatments | Haze 1% |
| | Viewing Angle (CR>10) | R/L: 178 degree (89/89) U/D: 178 degree (89/89) |
| | Contrast Ratio | Typ. 1200 : 1 |
| | Response Time(Typ.) | 8.0ms |
| | Average Brightness | Typ. 400 cd/ m ² |
| | Frame Rate | Typ. 60Hz |
| | Backlight Unit | LED |
| Input Resolution | Prime | 1920 x 1080 @ 60 Hz |
| | Standard | 640x480 @60Hz/70Hz/75Hz 800x600 @56/60/72/75 Hz, 1024x768 @60/70/75 Hz, 1280x1024 @60/75 Hz, 1280x720@60Hz 1366x768@60Hz,1600x900@60Hz, 1680x1050@60Hz,1920x1080@60Hz |

| | | |
|--|------------|---|
| Input Signal Port | VGA | 15pin D-Sub x 1Port |
| | DVI-D | 24pin DVI-D x 1 Port |
| | Power Jack | Power Mini-Din 4P x 1 Port |
| Scanning Frequency | Horizontal | 31 ~ 80Khz |
| | Vertical | 55 ~75Hz |
| OSD Control | | Menu, Select, Up, Down, Power |
| Plug & Play | | VESA DDC 2B Ver1.3 |
| Safety Glass | | Tempered Glass 744.0mm x 482.0mm x 3.0T |
| LED Frame Illumination (Without Controller) | | Front Type, 4 sided |
| | | LED Type : w/o IC Type (AT556M1SE3) |
| | | Supports External 12V RGB-type LED Lighting Controller |
| | | Interface Port : Molex 43020-0600 |
| RoHS | | RoHS2 Compliance |
| Mounting Options | | 200 x 200mm M4 VESA Mounting Holes |
| Optional Accessories | | Cables, Power Supply <for Addressable style, also say LED Lighting Controller> |

Application Caution

- 1. Precautions for strong light exposure.**
Strong light exposure causes degradation of polarizer and color filter.

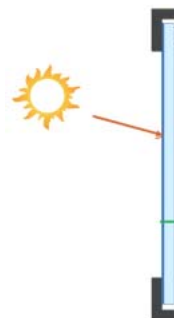

- 2. Using Conditions.**
- Temperature inside the cabinet should be controlled 'at room temp' (0 ~ 40°C) by cooler and fan.

1.3 Environmental and Reliability Specification

- This specification depends on the LCD panel characteristics. Please refer to the manufacturer's panel specification for details.

| Item | Symbol | Min | Max | Unit |
|-----------------------|--------|-----|-----|------|
| Operating Temperature | TOP | 0 | +50 | °C |
| Operating Humidity | HOP | 10 | 80 | % |
| Storage Temperature | TST | -20 | +60 | °C |
| Storage Humidity | HST | 10 | 80 | % |

1.4 Power Supply Rating

| | | | | |
|--|-------------------------|------|------|------|
| Optional PSU Input Voltage | AC 100 ~ 240VAC,50/60Hz | | | |
| Optional PSU Output Voltage | DC 24V/5.0A | | | |
| Monitor DC Input Voltage | 24VDC | | | |
| Power Consumption | 2.0A | | | |
| LED String Lighting Specification (w/o IC RGB 12V Type) | Min | Typ. | Max | Unit |
| Input Voltage | 11.4 | 12.0 | 12.6 | [V] |
| Input Current | | 1.8 | | [A] |
| Power Consumption | | 21.6 | | [W] |

- Conditions of Measurement
 - 1) LED pattern: LED Bar full white light, non-scrolling.
 - 2) Current consumption tolerance: + 10%.

1.5 Input/Output Port

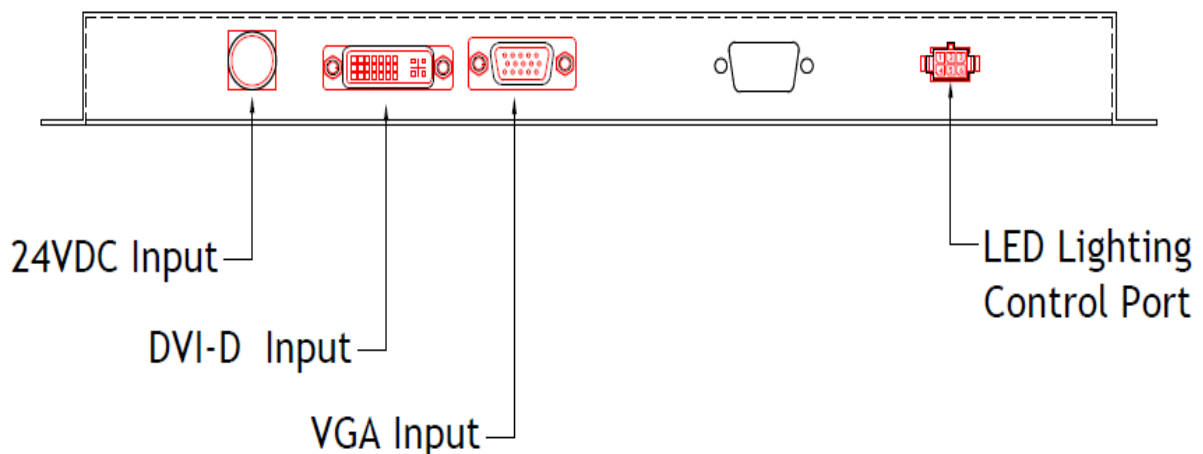

2. User Control & OSD

2.1 Key Control Board

K002

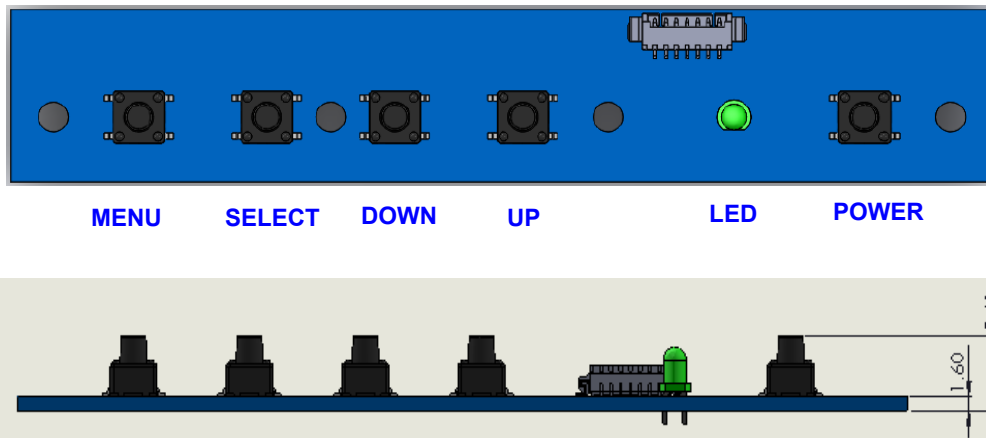

| Button | Function | Status | HOT Key |
|--------|---|--|---------------------------------------|
| LED | Indicates operation status | Green : Normal State Red : Off Mode Green Blinking : DPMS Mode | |
| POWER | Power on/off | | |
| MENU | Enable MENU Window Disable MENU Window Exit from Sub function | | |
| SELECT | Select function | | No OSD Window, Input Source Change |
| DOWN | Move to Down or Left | | No OSD Window, Auto Color |
| UP | Move to Up or Right | | No OSD Window, Auto Configuration |

2.2 OSD Control Function

The chosen OSD settings will be stored in memory. The OSD menu can be cleared from the screen by pressing the **MENU** button otherwise it will be automatically cleared after a few second of non-use.

2.2.1 OSD Main Menu

1) PICTURE

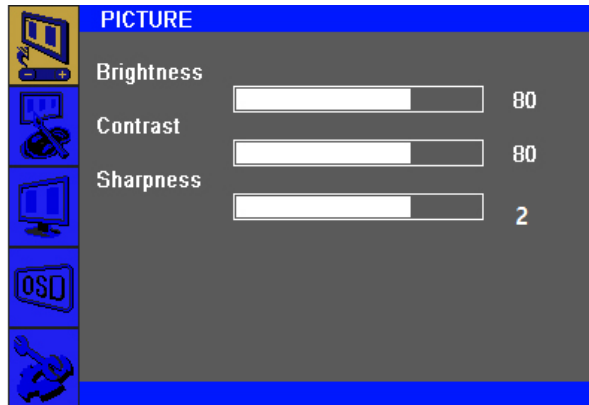

| | |
|----------------------|--|
| Brightness (0 ~ 100) | Increases/decreases monitor Brightness. Default: 100 |
| Contrast (0 ~ 100) | Increases/decreases monitor Contrast. Default: 100 |
| Sharpness (0 ~ 4) | Adjusts Sharpness of the displayed images. Default : 2 |

2) COLOR

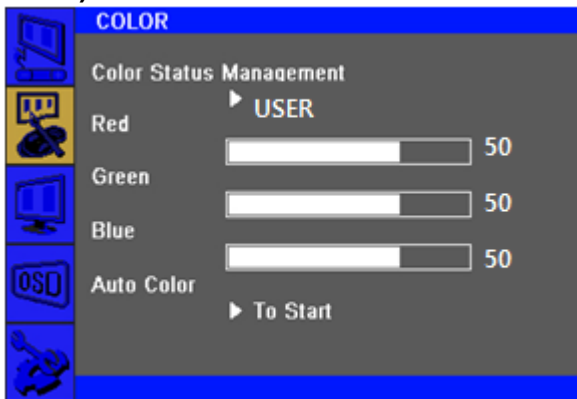

| | |
|-------------------------|--|
| Color Status Management | Selects the display's color temperature. The available color settings "Normal", "Warm", "Cool", "User", "Game" mode. Default : User |
| Red (0 ~ 100) | Increases/decreases Red Color Temperature. Default : 50 |
| Green (0 ~ 100) | Increases/decreases Green Color Temperature. Default : 50 |
| Blue (0 ~ 100) | Increases/decreases Blue Color Temperature. Default : 50 |
| Auto Color | Automatically adjusts the system color to the input VGA. |

3) SCREEN (VGA input only)

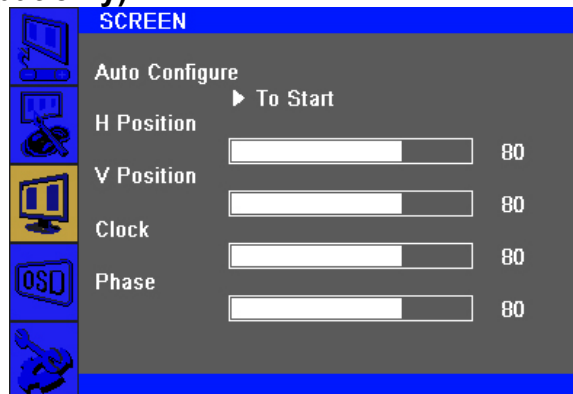

| | |
|----------------------|---|
| Auto Configure | Automatically adjusts the system clock to the input VGA. |
| H Position (0 ~ 100) | Moves the image horizontally on the display in single-pixel increments. Default : 50 |
| V Position (0 ~ 100) | Moves the image vertically on the display in single-pixel increments. Default : 50 |
| Clock (0 ~ 100) | Allows fine adjustments of the panel's pixel dot clock. Default : 50 |
| Phase (0 ~ 100) | Allows fine adjustments of the panel's pixel dot clock phase. Default : 50 |
| WXGA Mode | Selects WXGA Mode Off, 1024 x 768, 1280 x 768, 1360 x 768, 1366 x 768 Default : Off |

4) OSD

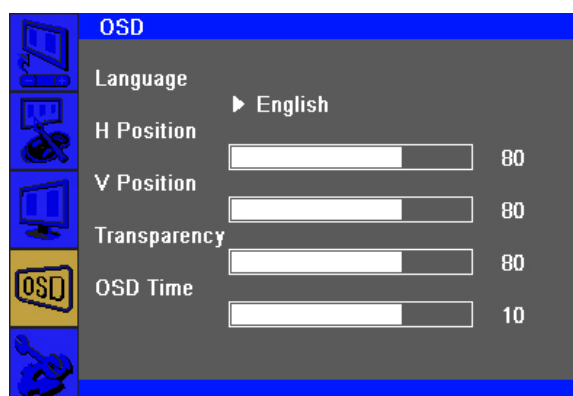

| | |
|----------------------|---|
| Language | Selects the OSD's display language. The available languages are English, Deutsch, Français, Italiano, Español, Korean. Default : English |
| H Position (0 ~ 100) | Adjusts the horizontal location of the OSD menus on the display. Default : 50 |

| | |
|-------------------------------|--|
| V Position (0 ~ 100) | Adjusts the vertical location of the OSD menus on the display. Default : 50 |
| Transparency (0 ~ 100) | Adjusts the transparency of the OSD menus on the display. Default : 33 |
| OSD Time (0 ~ 60) | Adjusts how long the touch monitor will wait without OSD button activity before closing the OSD. The adjustable range is between 0 and 60 seconds. Default : 10 |

5) SETUP

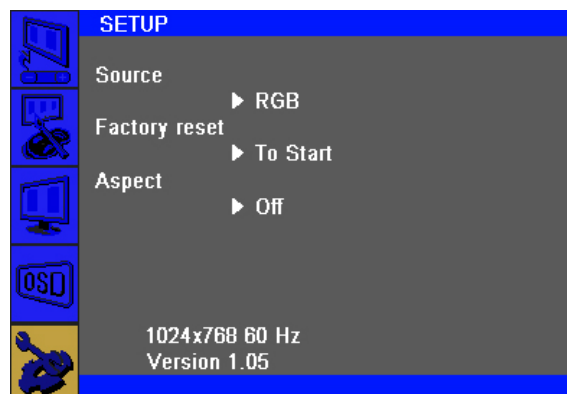

| | |
|----------------------|---|
| Source | Selects Input Source VGA (RGB), DVI. |
| Factory reset | Restores all factory default settings for OSD-adjustable parameters and for Preset Video Mode timings. |
| Aspect | Switches the scaling method between Full Scaling and Maintain Aspect Ratio. Default : Off |

3. Connector Description

3.1 Summary

| Reference | Item | Description | Type | Manufacture |
|-----------|-----------|--|-------------|-------------|
| J6 | Connector | External 24VDC Power Input Connector | 20010WS-04 | YEONHO |
| J8 | Connector | Auto-Dimming/RS232 Connector | SMW200-04 | YEONHO |
| J1 | Connector | Backlight Inverter Connector | SMAW200-8 | YEONHO |
| J15 | Connector | OSD Board Connector | SMAW200-07 | YEONHO |
| J2 | Connector | 12VDC/5VDC External Power Output Connector | SMAW200-6 | YEONHO |
| J4 | Jack | 24VDC Input Power Jack | Mini-Din 4P | - |
| J11 | Connector | DVI-D Input(TMDS) Connector | DVI-D24P | - |
| J23 | Connector | VGA Input Connector | 15P D-SUB | - |
| J14 | Connector | LCD Interface Connector(2Ch LVDS) | YDW200-30 | YEONHO |

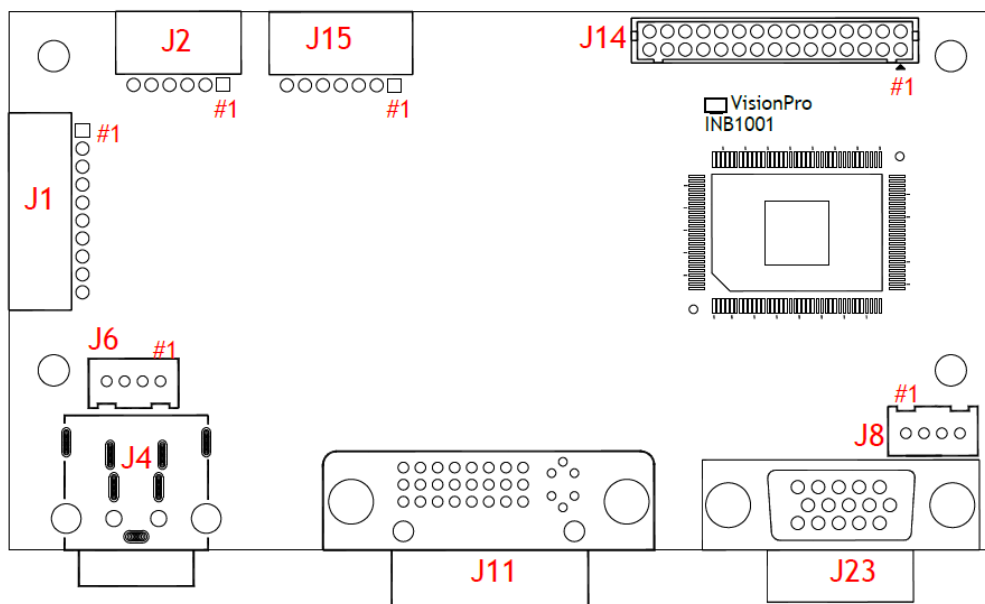

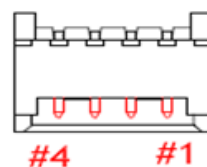

3.2 J6: 24VDC Power Input Connector

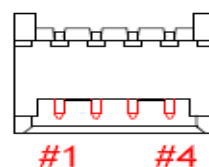
| Pin No. | Symbol | Description |
|---------|--------|-------------|
| 1 | VCC | 24VDC |
| 2 | VCC | 24VDC |
| 3 | GND | Ground |
| 4 | GND | Ground |

3.3 J8: Auto-Dimming / RS232 Connector

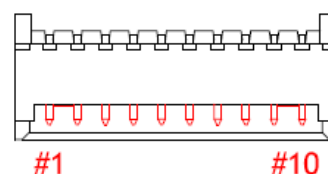
| Pin No. | Symbol | Description |
|---------|-----------------|--------------|
| 1 | RS232 RX | RS232 RX |
| 2 | RS232 TX | RS232 TX |
| 3 | Auto- Backlight | Auto-Dimming |
| 4 | GND | Ground |

3.4 J1: Backlight Inverter Connector

| Pin No. | Symbol | Description |
|----------|---------|---|
| 1 | DIM-ADJ | DIM-adjustment analog dimming control signal. * make sure inverter specification |
| 2 | ON/OFF | Inverter digital ON (3.3V)/OFF(0V) signal. |
| 3,4,5,6 | GND | Ground |
| 7,8,9,10 | VCC | 24VDC |

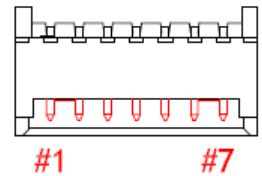
3.5 J15: OSD Board Connector

| Pin No. | Symbol | Description |
|---------|---------|----------------------------|
| 1 | VCC | +5V Power for IR sensor |
| 2 | IRQ | Infrared rays signal line. |
| 3 | LED1 | Green LED |
| 4 | LED2 | Red LED |
| 5 | GND | Ground |
| 6 | ADC-IN0 | Menu, Up |
| 7 | ADC-IN1 | Power, Down, Up |

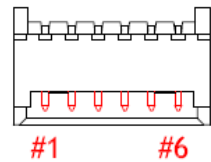
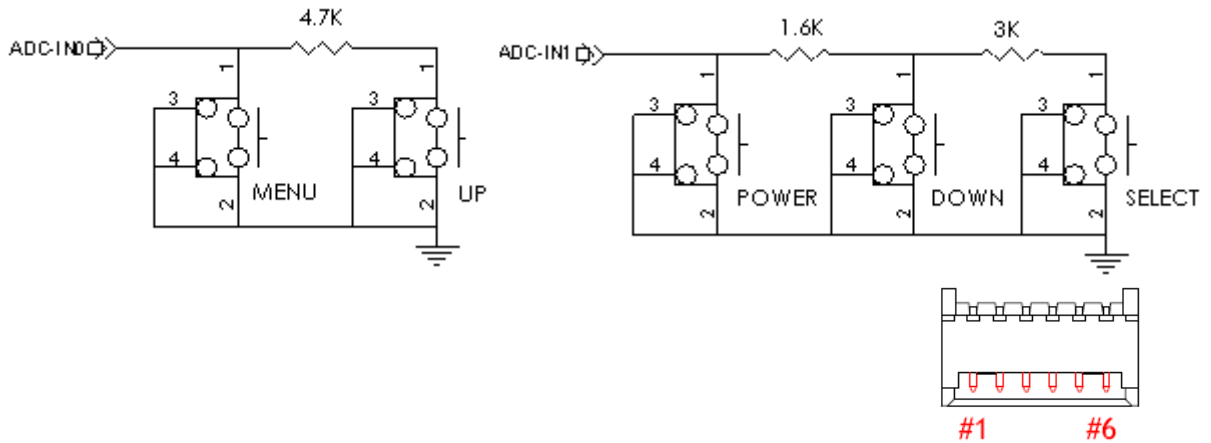
3.6 J2: 12VDC / 5VDC External Power Output Connector

| Pin No. | Symbol | Description |
|---------|--------|--------------|
| 1 | 12V | 12VDC Output |
| 2 | 12V | 12VDC Output |
| 3 | 5V | 5VDC Output |
| 4 | 5V | 5VDC Output |
| 5 | GND | Ground |
| 6 | GND | Ground |

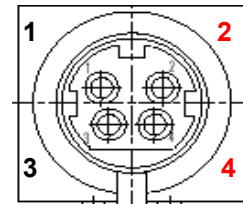
3.7 J4: 24VDC Power Input Jack

| Pin No. | Symbol | Description |
|---------|--------|-------------|
| 1,3 | GND | Ground |
| 2,4 | VCC | 24VDC |

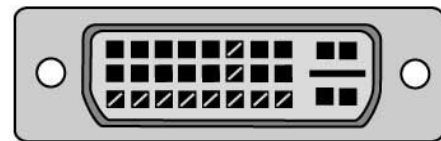
3.8 J11: DVI-D Input (TMDS) Connector

| Pin No. | Symbol | Description |
|---------|-------------------|--|
| 1 | TMDS DATA2- | TMDS DATA2 Differential Negative Signal |
| 2 | TMDS DATA2+ | TMDS DATA2 Differential Positive Signal |
| 3 | TMDS DATA2 Shield | Shield for TMDS Channel #2 |
| 4 | NC | No Connection |
| 5 | NC | No Connection |
| 6 | DDC Clock | The Data Line for the DDC Interface |
| 7 | DDC Data | The Clock Line for the DDC Interface |
| 8 | NC | No Connection |
| 9 | TMDS DATA1- | TMDS DATA1 Differential Negative Signal |
| 10 | TMDS DATA1+ | TMDS DATA1 Differential Positive Signal |
| 11 | TMDS DATA1 Shield | Shield for TMDS Channel #1 |
| 12 | NC | No Connection |
| 13 | NC | No Connection |
| 14 | +5V Power | +5 Volt signal for EDID (Un-powered Monitor) |
| 15 | GND(for +5V) | Ground for +5 Volt Power pin, Sync return |
| 16 | HPD | Identify the Presence of a Monitor |
| 17 | TMDS DATA0- | TMDS DATA0 Differential Negative Signal |
| 18 | TMDS DATA0+ | TMDS DATA0 Differential Positive Signal |
| 19 | TMDS DATA0 Shield | Shield for TMDS Channel #0 |
| 20 | NC | No Connection |
| 21 | NC | No Connection |
| 22 | TMDS CLOCK Shield | Shield for TMDS Clock Differential Pair |
| 23 | TMDS CLOCK+ | TMDS DATA0 Differential Positive Signal |
| 24 | TMDS CLOCK- | TMDS DATA0 Differential Negative Signal |

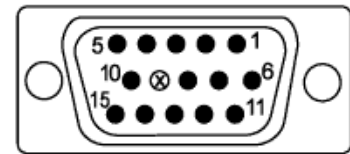
3.9 J23: VGA Input Connector

| Pin No. | Symbol | Description |
|---------|--------|--------------------|
| 1 | Red1 | Red Analog Input |
| 2 | Green1 | Green Analog Input |
| 3 | Blue1 | Blue Analog Input |
| 4 | GND | Ground |
| 5 | GND | Ground |
| 6 | GND | Ground |
| 7 | GND | Ground |
| 8 | GND | Ground |
| 9 | NC | No Connection |
| 10 | GND | Ground |
| 11 | GND | Ground |
| 12 | DSDA | DDC-SDA |
| 13 | HSYNC | Horizontal Sync |
| 14 | VSYNC | Vertical Sync |
| 15 | DSCL | Serial Clock Input |

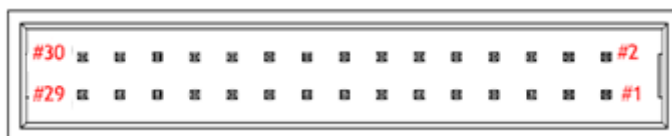
3.10 J14: LCD Interface Connector (8bit 2Ch LVDS)

| Pin No. | Symbol | Description |
|---------|----------|---|
| 1 | MOD_PWR | Panel Power (12V, 5V or 3.3V) |
| 2 | MOD_PWR | Panel Power (12V, 5V or 3.3V) |
| 3 | Option | High/Low for LCD Option |
| 4 | MOD_PWR | Panel Power (12V, 5V or 3.3V) |
| 5 | NC | No Connection |
| 6 | NC | No Connection |
| 7 | GND | Ground |
| 8 | GND | Ground |
| 9 | Y3N-EVEN | Negative(-) LVDS differential second 3 data |
| 10 | Y3P-EVEN | Positive(+) LVDS differential second 3 data |
| 11 | YCN-EVEN | Negative(-) LVDS differential second Clock |
| 12 | YCP-EVEN | Positive(+) LVDS differential second Clock |
| 13 | Y2N-EVEN | Negative(-) LVDS differential second 2 data |
| 14 | Y2P-EVEN | Positive(+) LVDS differential second 2 data |
| 15 | Y1N-EVEN | Negative(-) LVDS differential second 1 data |
| 16 | Y1P-EVEN | Positive(+) LVDS differential second 1 data |
| 17 | Y0N-EVEN | Negative(-) LVDS differential second 0 data |
| 18 | Y0P-EVEN | Positive(+) LVDS differential second 0 data |
| 19 | GND | Ground |
| 20 | GND | Ground |
| 21 | Y3N- ODD | Negative(-) LVDS differential first 3 data |
| 22 | Y3P-ODD | Positive(+) LVDS differential first 3 data |
| 23 | YCN- ODD | Negative(-) LVDS differential first Clock |
| 24 | YCP- ODD | Positive(+) LVDS differential first Clock |
| 25 | Y2N- ODD | Negative(-) LVDS differential first 2 data |
| 26 | Y2P- ODD | Positive(+) LVDS differential first 2 data |
| 27 | Y1N- ODD | Negative(-) LVDS differential first 1 data |
| 28 | Y1P- ODD | Positive(+) LVDS differential first 1 data |
| 29 | Y0N- ODD | Negative(-) LVDS differential first 0 data |
| 30 | Y0P- ODD | Positive(+) LVDS differential first 0 data |

4. Standard Display Modes

| ITEM | STD | Resolution | Pixel Frequency (MHz) | Vertical Frequency (Hz) | Horizontal Frequency (KHz) | Sync. Polarity (H/V) | Remark |
|------|------|------------------|-----------------------|-------------------------|----------------------------|----------------------|---------------|
| 1 | | 640*400 | 25.175 | 59.940 | 31.469 | | |
| 2 | | 640*480 | 25.175 | 59.940 | 31.469 | | VGA |
| 3 | VESA | 640*480 | 25.200 | 60.000 | 31.500 | | VGA |
| 4 | VESA | 640*480 | 31.500 | 72.809 | 37.861 | | VGA |
| 5 | VESA | 640*480 | 31.500 | 75.000 | 37.500 | | VGA |
| 6 | IBM | 720*400 | 28.322 | 70.087 | 31.469 | | |
| 7 | VESA | 800*600 | 36.000 | 56.250 | 35.156 | | SVGA |
| 8 | VESA | 800*600 | 40.000 | 60.317 | 37.879 | | SVGA |
| 9 | VESA | 800*600 | 50.000 | 72.188 | 48.077 | | SVGA |
| 10 | VESA | 800*600 | 49.500 | 75.000 | 46.875 | | SVGA |
| 11 | VESA | 1024*768 | 65.000 | 60.000 | 48.363 | | XGA |
| 12 | VESA | 1024*768 | 75.000 | 70.069 | 56.476 | | XGA |
| 13 | VESA | 1024*768 | 78.750 | 75.029 | 60.023 | | XGA |
| 14 | | 1152*864 | 94.500 | 70.012 | 63.851 | | |
| 15 | VESA | 1152*864 | 108.000 | 75.000 | 67.500 | | |
| 16 | | 1280*720 | 74.501 | 59.856 | 44.772 | | WXGA |
| 17 | | 1280*768 | 79.499 | 59.870 | 47.776 | | WXGA |
| 18 | VESA | 1280*960 | 108.000 | 60.000 | 60.000 | | WXGA |
| 19 | | 1360*768 | 72.000 | 59.960 | 47.368 | | WXGA |
| 20 | VESA | 1280*1024 | 108.000 | 60.020 | 63.981 | | SXGA |
| 21 | VESA | 1280*1024 | 135.000 | 75.025 | 79.976 | | |
| 22 | | 1680*1050 | 146.250 | 59.954 | 65.290 | | WSXGA+ |
| 23 | | 1600* 900 | 118.998 | 55.920 | 60.000 | | |
| 24 | | 1920*1080 | 138.500 | 59.934 | 66.587 | | |
| 25 | | 1920*1080 | 148.500 | 60.000 | 67.500 | | 1080P |
| 26 | | 1920*1080 | 148.352 | 59.940 | 67.433 | | 1080P |

5. LED Backlight Driver Board Specification

5.1 Electrical Specification

| Item | Symbol | Spec | Unit | Remarks |
|-----------------------|----------|------------|------|---------|
| Input Voltage 1 | Vin | 23.0 ~25.0 | V | |
| Input Voltage 2 | ON / OFF | 0 ~ 5.0 | V | |
| Operating Temperature | TOP | 0 ~ 50 | °C | |
| Storage Temperature | Tstg | -20 ~60 | °C | |
| Relative Humidity | RH | 80 | % | |

5.2 Control Signal

| Item | Symbol | Status | Action | Remarks |
|---------|--------|--------|---------|---------|
| CN1 #12 | ON/OFF | HIGH | LED-ON | 5.0V |
| | | LOW | LED-OFF | 0V |

5.3 Output Characteristics

| NO | Item | Symbol | Min | Type | Max | Unit |
|----|--------------------|---|-----------|------|----------|------|
| 1 | Input Voltage | Vin | 20.8 | 24 | 26 | V |
| 2 | Input Current | Iin | | 0.7 | 2 | A |
| 3 | Input Power | Pin | | 36 | 52 | W |
| 4 | Brightness Voltage | Vadj | 0(bright) | --- | 5 (dark) | V |
| 5 | Control Voltage | Enable Von=1.5---5.0V Disable Voff=0---0.5V | | | | |

| Item | Symbol | Test Conditions | Min | Type | Max | Unit |
|----------------------------|--------|--|-----|------|-------|------|
| Output Current (per group) | Iout | Vin=24.0V; Vout=57V; Ta=28°C | | 540 | 750 | mA |
| Output Voltage | Vout | Vin=24.0V; Ta=28°C | 30 | 66 | 85 | V |
| Efficiency | η | Vin=24.0V; Vout=57V; | | 92.5 | | % |
| Output total group | Ggp | | | 1 | | |
| The Total Output Current | R | According to the backlight parameters to adjust output current | | 540 | 750 | MA |
| output power | W out | Vin=24.0V; Vout=30-85V; | | 36 | 63.75 | W |

5.4 Interface

5.4.1 CN1 Connector: 20010WR-14 (YeonHo) or EQ

| Pin | Symbol | Remarks |
|------------|--------|------------------------------------|
| 1,2,3,4,5 | Vin | Input Voltage 24VDC |
| 6,7,8,9,10 | GND | GND |
| 12 | On/Off | Backlight On/Off (5V:On, 0V : Off) |
| 13 | PDIM | External PWM |
| 14,11 | NC | No Connection |

6. Board Dimensions

6.1 AD Board (INB1001) Dimension (110mm x 60mm x 14.5mm)

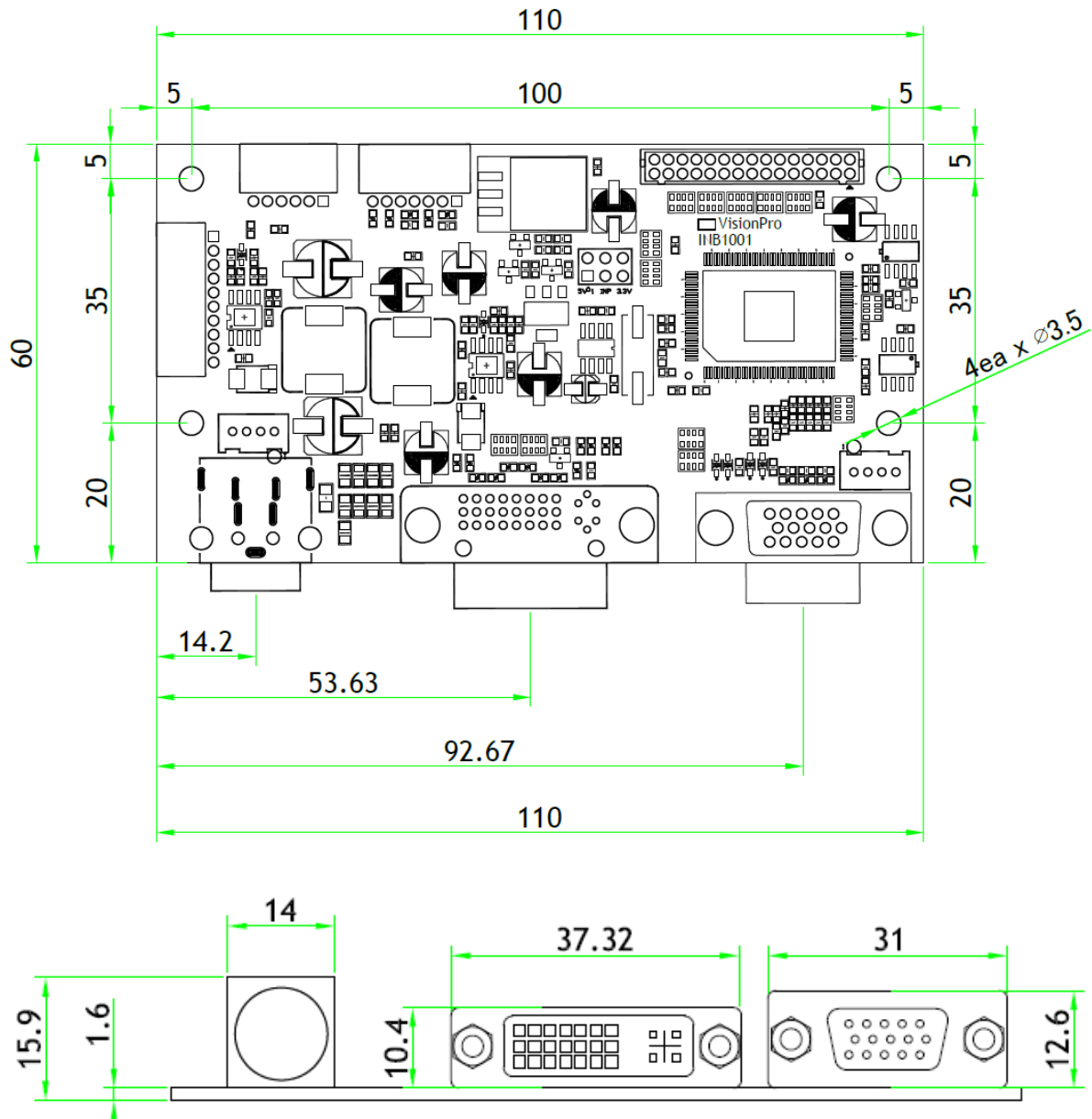

6.2 OSD Board (K002) Dimension (115mm x 20mm x 8.7mm)

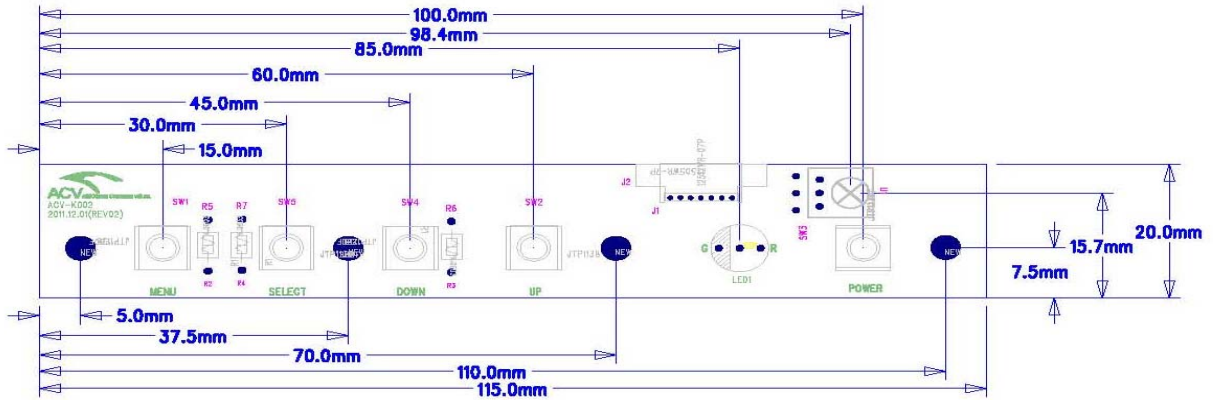

7. LED Lighting Control Interface Specification

7.1 Connector Spec

- Connector: Molex 43020-0600



- Matching Housing: Molex 43025-0600



7.2 External LED Connector Pin Map

7.2.1 Without IC LED Bar Board

LED Lighting Control Port Pin Map
 #1 : Red , #2 : Green , #3 : Blue
 #4 : VCC 12V , #5 : GND , #6 NC

| Pin No | Symbol | Remark |
|--------|--------|------------------------|
| 1 | RED | Red LED Control Line |
| 2 | GRN | Green LED Control Line |
| 3 | BLU | Blue LED Control Line |
| 4 | VCC | VCC 12V Input |
| 5 | GND | GND |
| 6 | NC | Not Connection |

7.3 Without IC LED Specification

7.3.1 LED Pin Configuration

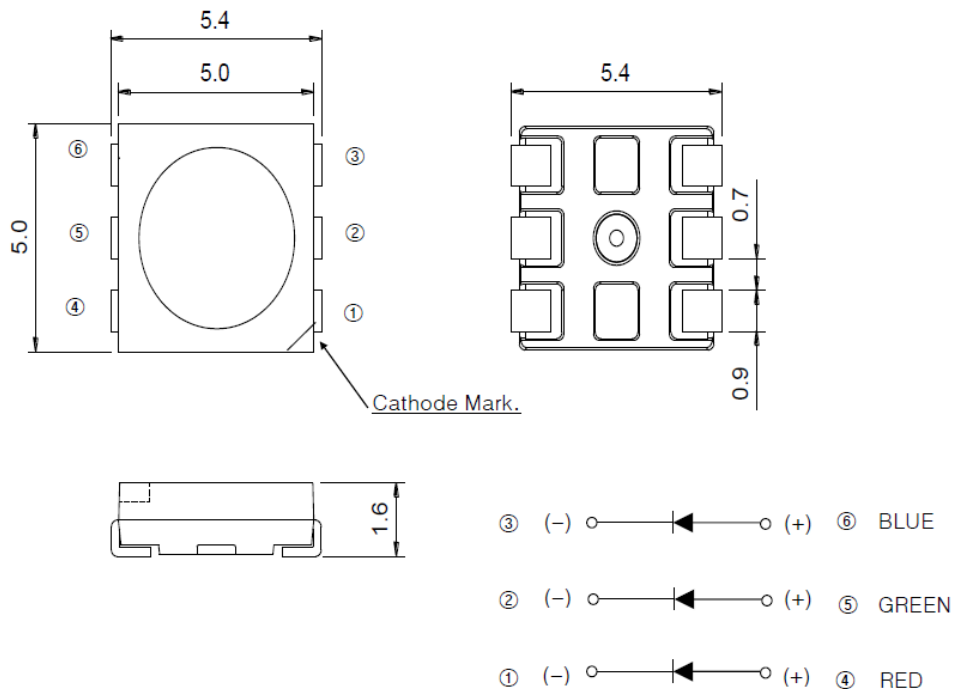

8. Packing Information

| Item | Q'ty | Dimension (W x H x D) | Weight(Kg) | Remark |
|----------------|------|----------------------------|------------|--------|
| Closed Frame | 1Pcs | 774.0mm x 482.0mm x 65.0mm | TBD | |
| Box Packing | | | TBD | |
| Pallet Size | | | TBD | |
| Pallet Packing | | | TBD | |

9. Mechanical Structure

| Rev | AMEND | DATE | CHECK | APPR. |
|-----|-------|------------|---------|----------|
| P1 | Proto | 2019.09.02 | H.I.Woo | H.Y.Sohn |
| P2 | | | | |
| P3 | | | | |

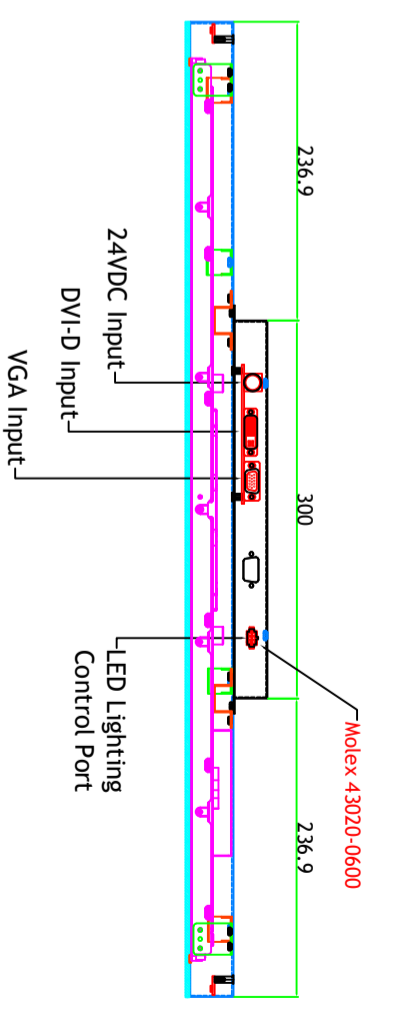
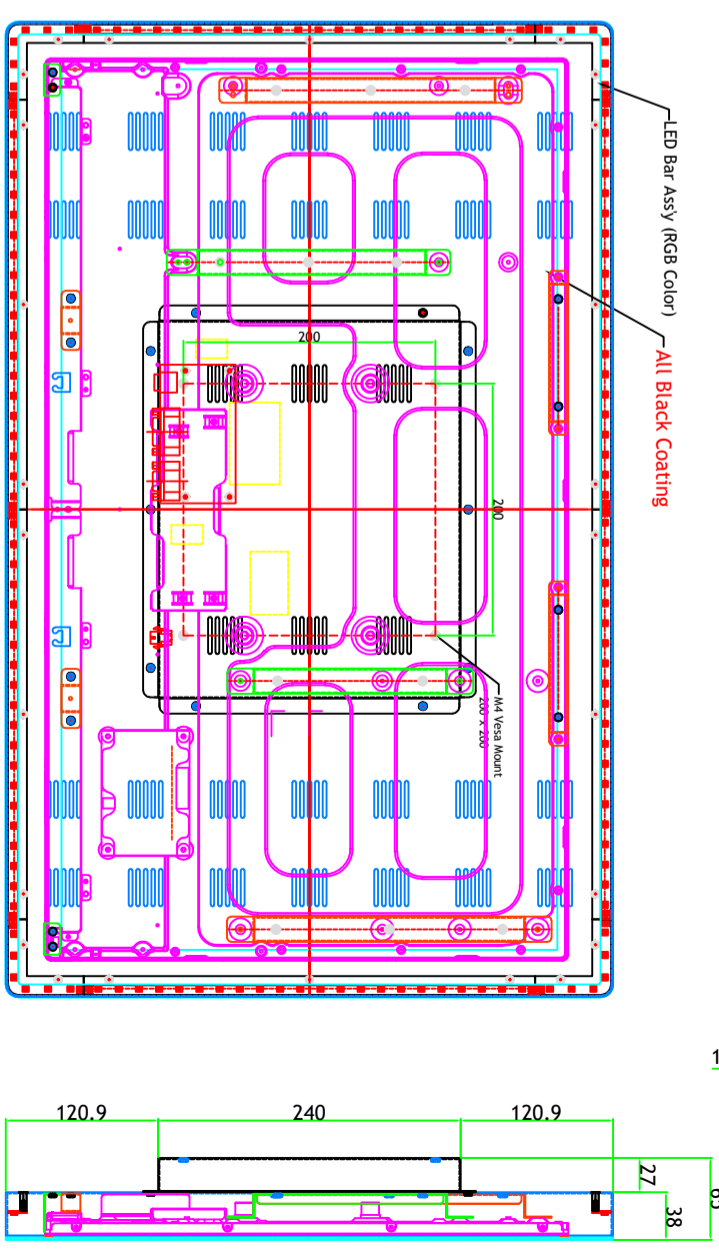
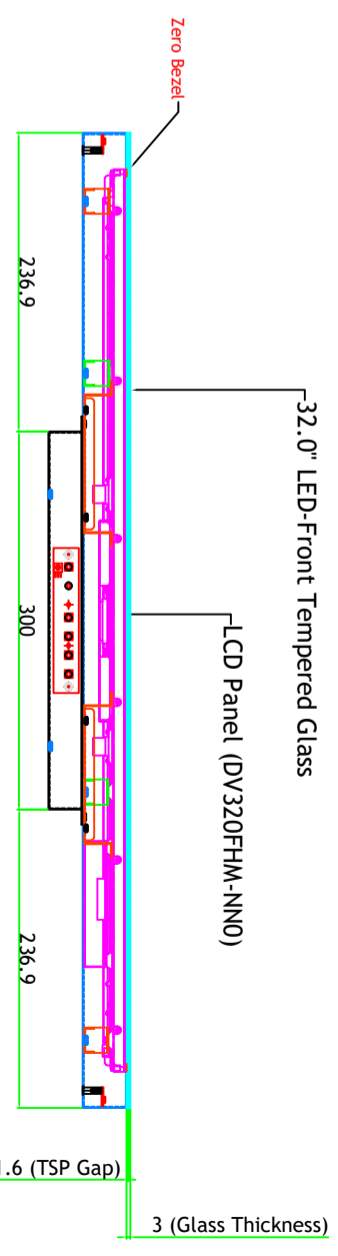
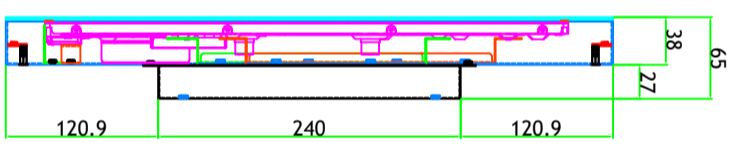
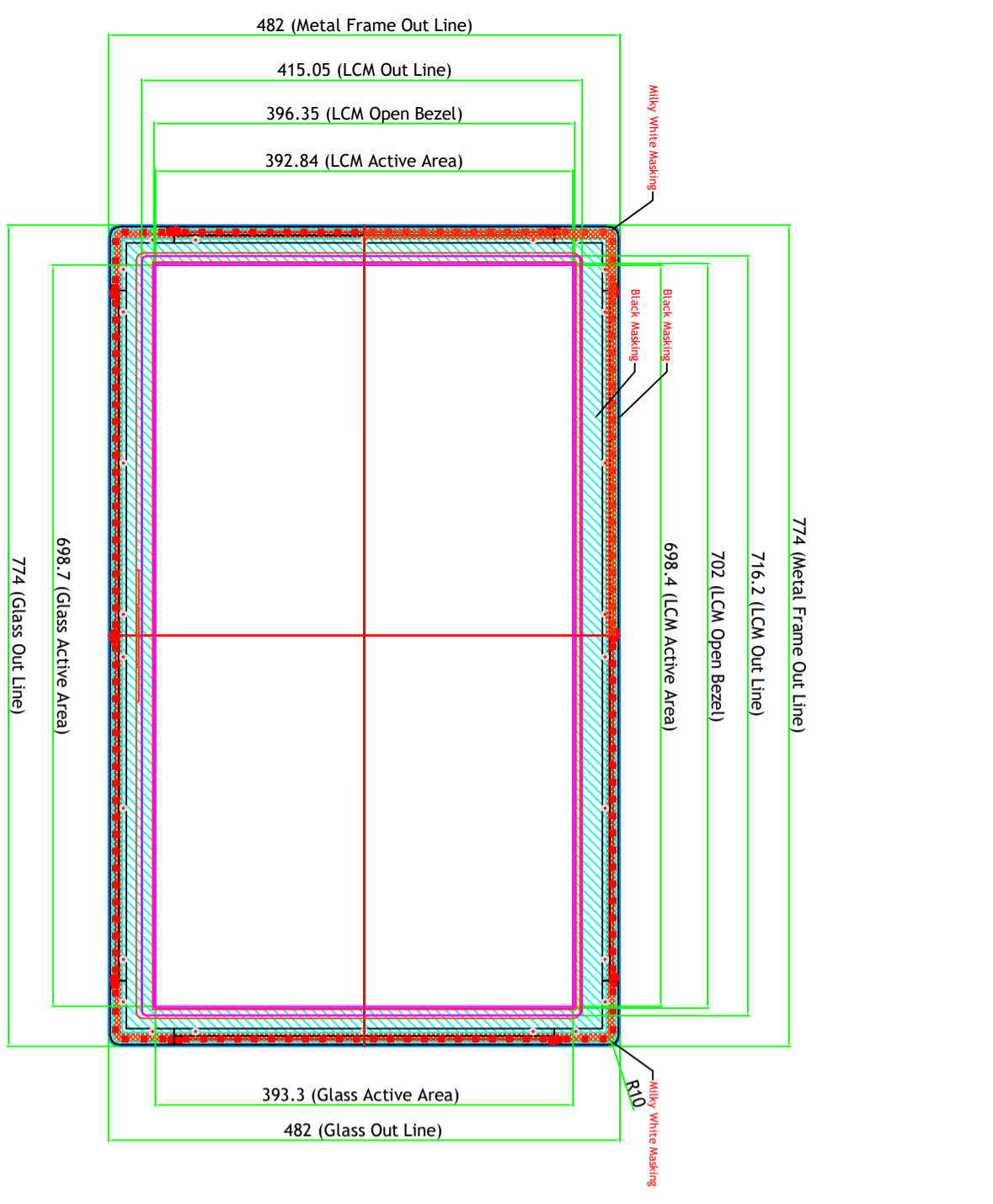

LED Lighting Control Port Pin Map (w/o IC)
 #1 : Red, #2 : Green, #3 : Blue
 #4 : VCC 12V, #5 : GND, #6 NC

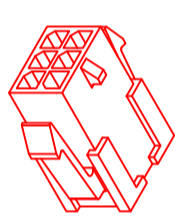
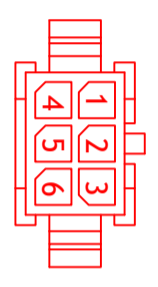

Molex 43020-0600

Main Frame GI = 1.2T Black Coating
 Rear Cover GI = 1.0T Black Coating

| | | | | | | |
|----------|---------|----------|-------------------|--------------|-------|------------|
| SUZOHAPP | | MODEL NO | 150LG3200 | | VIEW | UNIT : mm |
| | | NAME | 32" Closed Frame | | QTY | |
| DRAWN | CHECKED | APPROVED | DWG. NO | 4M3203044-00 | SCALE | 1 / 1 |
| H.I.Woo | | H.Y.Sohn | MATERIAL / FINISH | EGI T=1.2 | DATE | 2019.09.02 |

| Rev | AMEND | DATE | CHECK | APPR. |
|-----|-------|------------|---------|----------|
| P1 | Proto | 2019.09.02 | H.I.Woo | H.Y.Sohn |
| P2 | | | | |
| P3 | | | | |

Front View

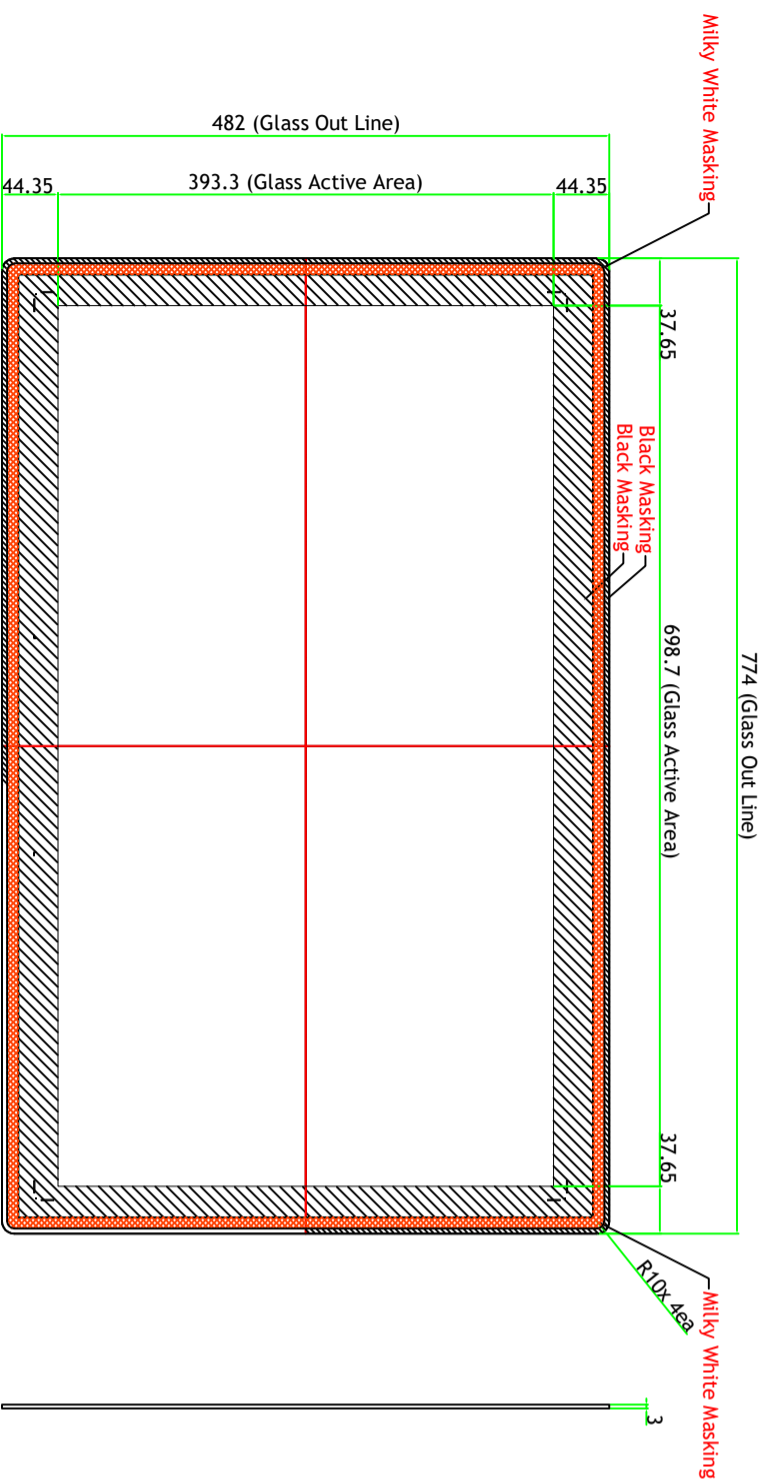

Rear View

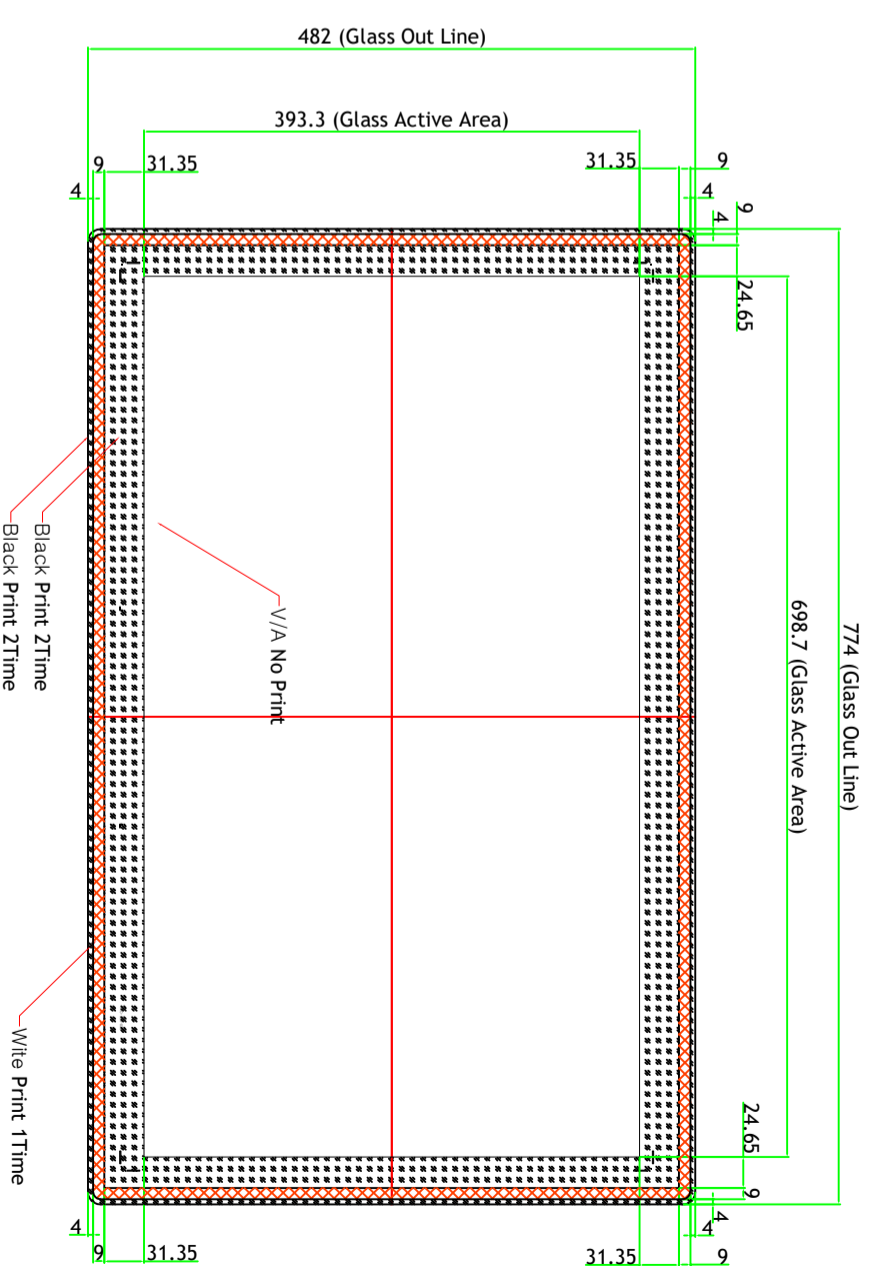

- Black Masking : 2time
- Milky White : 1time
- Touch Align Masking : 1time

PGLSHT3203001 32.0" LED-Front Model Glass Drawing

| | | | | | | | | | |
|---------|---------|----------|-------------------|--------------|--------|-------|--------|------|------------|
| | | MODEL NO | 150LG3200 | | VIEW : | | UNIT : | mm | |
| | | NAME | 32" Closed Frame | | Qty | | 1 | | REV. |
| DRAWN | CHECKED | APPROVED | DWG. NO | 4M3203044-00 | SCALE | 1 / 1 | | DATE | 2019.09.02 |
| H.I.Woo | | H.Y.Sohn | MATERIAL / FINISH | EGI T=1.2 | | | | | |

| ASSEMBLY ITEM NUMBER | PART CHARACTERISTICS | | MATERIAL |
|----------------------|----------------------|--------------------|----------|
| | NUMBER OF POSITION | PANEL MOUNT OPTION | |
| | 43020-0200 | 02 | |
| 43020-0201 | 02 | NO | |
| 43020-0400 | 04 | YES | |
| 43020-0401 | 04 | NO | |
| 43020-0600 | 06 | YES | |
| 43020-0601 | 06 | NO | |
| 43020-0800 | 08 | YES | |
| 43020-0801 | 08 | NO | |
| 43020-1000 | 10 | YES | |
| 43020-1001 | 10 | NO | |
| 43020-1200 | 12 | YES | |
| 43020-1201 | 12 | NO | |
| 43020-1400 | 14 | YES | |
| 43020-1401 | 14 | NO | |
| 43020-1600 | 16 | YES | |
| 43020-1601 | 16 | NO | |
| 43020-1800 | 18 | YES | |
| 43020-1801 | 18 | NO | |
| 43020-2000 | 20 | YES | |
| 43020-2001 | 20 | NO | |
| 43020-2200 | 22 | YES | |
| 43020-2201 | 22 | NO | |
| 43020-2400 | 24 | YES | |
| 43020-2401 | 24 | NO | |

| CKT. NO. | DIM. 'A' | DIM. 'B' | DIM. 'C' | DIM. 'D' |
|----------|---------------|---------------|---------------|---------------|
| 2 | .152/(3.86) | N/A | .166/(4.21) | .311/(7.90) |
| 4 | .270/(6.85) | .118/(3.00) | .284/(7.21) | .429/(10.90) |
| 6 | .388/(9.85) | .236/(6.00) | .402/(10.21) | .547/(13.89) |
| 8 | .506/(12.85) | .354/(9.00) | .520/(13.21) | .665/(16.89) |
| 10 | .624/(15.85) | .472/(12.00) | .638/(16.21) | .783/(19.89) |
| 12 | .742/(18.85) | .591/(15.00) | .756/(19.21) | .901/(22.89) |
| 14 | .860/(21.85) | .709/(18.00) | .874/(22.20) | 1.019/(25.88) |
| 16 | .978/(24.85) | .827/(21.00) | .992/(25.20) | 1.137/(28.88) |
| 18 | 1.096/(27.85) | .945/(24.00) | 1.110/(28.20) | 1.255/(31.88) |
| 20 | 1.215/(30.85) | 1.063/(27.00) | 1.229/(31.22) | 1.373/(34.87) |
| 22 | 1.333/(33.85) | 1.181/(30.00) | 1.347/(34.22) | 1.491/(37.87) |
| 24 | 1.451/(36.85) | 1.299/(33.00) | 1.465/(37.22) | 1.609/(40.87) |

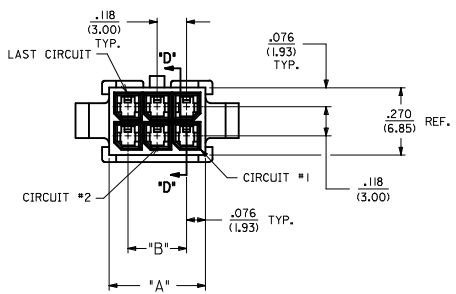

- NOTES:
- HOUSING MATERIAL:
 - 'A' - UNFILLED POLYESTER, RATED UL, 94V-0, COLOR IS BLACK.
 - 'B' - UNFILLED NYLON, RATED UL, 94V-0, HALOGEN-FREE, COLOR IS BLACK.
 - FINISH: N/A
 - PRODUCT SPECIFICATION: PS-43045
 - PACKAGING SPECIFICATION: PK-43020-001
 - THIS HOUSING MATES WITH MICRO-FIT RECEPTACLE #43025-****
 - THIS HOUSING TO BE USED WITH MOLEX MALE TERMINAL #43031-****
 - DESIGNED FOR .055(1.4) MINIMUM TO A .100(2.54) MAXIMUM THICK PANEL OR PRINTED CIRCUIT BOARD.
 - SEE SECTION 'D'-D' FOR TERMINAL ORIENTATION IN HOUSING.
 - PANEL MOUNT FEATURES MUST LOCK ON SIDE OPPOSITE PUNCH SIDE FOR OPTIMUM RETENTION.
 - PART CONFORMS TO CLASS 'B' REQUIREMENTS OF COSMETIC SPECIFICATION PS-45499-002. SOME HOUSINGS MAY HAVE A SMALL GATE BLEMISH NEAR THE GATE LOCATION THAT DOES NOT AFFECT FUNCTIONALITY.

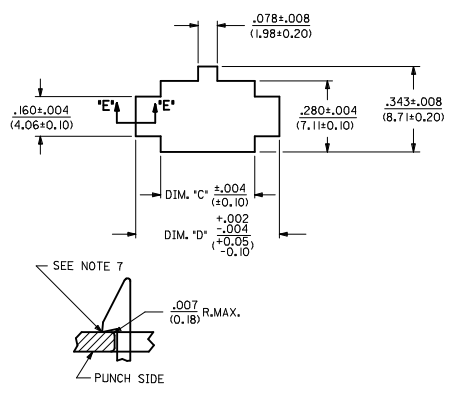

SECTION 'E'-E'
NO SCALE

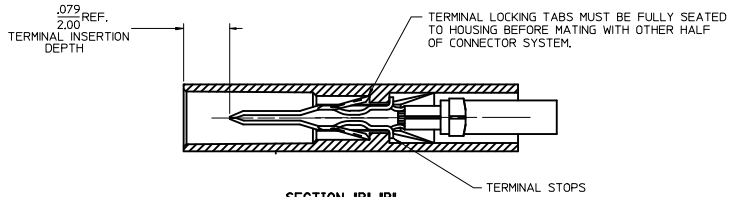
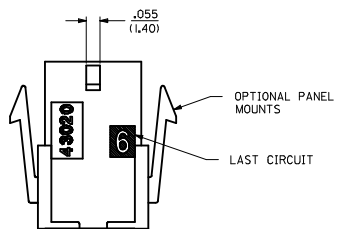
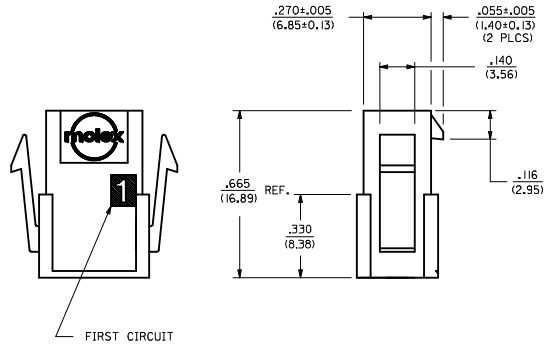

SECTION 'B'-B'

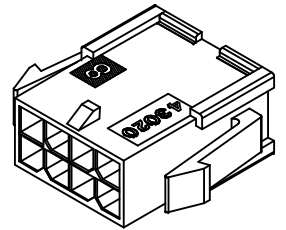

PLUG WITH OPTIONAL
PANEL MOUNTS
ISO VIEW
(8 CIRCUIT SHOWN)

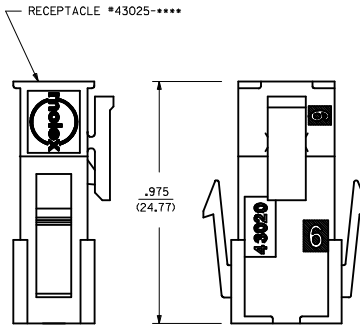

MATED MICRO-FIT CONNECTOR

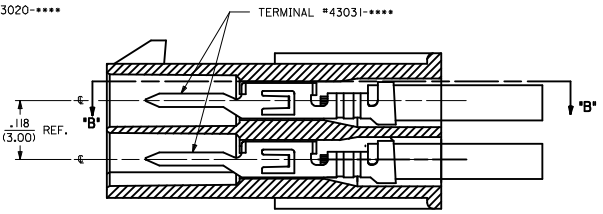

SECTION 'D'-D'
WITH TERMINAL
SCALE 8X

| QUALITY SYMBOLS | GENERAL TOLERANCES (UNLESS SPECIFIED) | DIMENSION STYLE | | SCALE | DESIGN UNITS | THIRD ANGLE PROJECTION |
|--|---------------------------------------|-----------------|------------|--|--------------|--|
| | | IN | MM | | | |
| ▽=0 | 4 PLACES ± .010 | INCH | DATE | 1:1 | METRIC | MICRO-FIT(3,0) 2 THRU 24 CIRCUIT PLUG WITH OPTIONAL PANEL MOUNTS |
| ▽=0 | 3 PLACES ± .010 | DATE | 1993/01/07 | | | |
| ▽=0 | 2 PLACES ± 0.25 ± .014 | DATE | 1993/01/07 | | | |
| ▽=0 | 1 PLACE ± 0.35 ± .014 | DATE | 2016/10/07 | | | |
| ▽=0 | 0 PLACE ± .010 ± .010 | DATE | 2016/10/07 | MATERIAL NO. SDA-43020-**** DOCUMENT NO. SDA-43020-**** SHEET NO. 1 OF 1 | | |
| DRAFT WHERE APPLICABLE MUST REMAIN WITHIN DIMENSIONS | | SEE CHART | | | | |

| PART CHARACTERISTICS | | |
|----------------------|----------------------|----------|
| NUMBER OF POSITION | ASSEMBLY ITEM NUMBER | MATERIAL |
| 02 | 43025-0200 | 'B' |
| 04 | 43025-0400 | |
| 06 | 43025-0600 | |
| 08 | 43025-0800 | |
| 10 | 43025-1000 | 'A' |
| 12 | 43025-1200 | |
| 14 | 43025-1400 | 'B' |
| 16 | 43025-1600 | 'A' |
| 18 | 43025-1800 | 'B' |
| 20 | 43025-2000 | |
| 22 | 43025-2200 | 'A' |
| 24 | 43025-2400 | |

| CKT. NO. | DIM. "A" +0.14 -0.10 +0.35 -0.25 | DIM. "B" |
|----------|--|---------------|
| 2 | .152/(3.86) | N/A |
| 4 | .270/(6.85) | .118/(3.00) |
| 6 | .388/(9.85) | .236/(6.00) |
| 8 | .506/(12.85) | .354/(9.00) |
| 10 | .624/(15.85) | .472/(12.00) |
| 12 | .742/(18.85) | .591/(15.00) |
| 14 | .860/(21.85) | .709/(18.00) |
| 16 | .978/(24.85) | .827/(21.00) |
| 18 | 1.096/(27.85) | .945/(24.00) |
| 20 | 1.215/(30.85) | 1.063/(27.00) |
| 22 | 1.333/(33.85) | 1.181/(30.00) |
| 24 | 1.451/(36.85) | 1.299/(33.00) |

- NOTES:**
- HOUSING MATERIAL:
'A' - UNFILLED POLYESTER, RATED UL, 94V-0, COLOR IS BLACK.
'B' - UNFILLED NYLON, RATED UL, 94V-0, HALOGEN-FREE, COLOR IS BLACK.
 - FINISH: N/A
 - PRODUCT SPECIFICATION: PS-43045
 - PACKAGING SPECIFICATION: PK-43025-001
 - THIS RECEPTACLE MATES WITH 43020, 43045.
 - THIS RECEPTACLE TO BE USED WITH MOLEX FEMALE TERMINAL SERIES 43030 OR 46235. SEE SECTION 'A'-A' FOR TERMINAL ORIENTATION IN HOUSING.
 - FOR OVERMOLDING PARAMETERS SEE ENGINEERING SPECIFICATION #SDS-43025-1000.
 - TOP PULL TABS ARE NOT AVAILABLE ON 2 AND 4 CIRCUIT PARTS.
 - MOLEX RECOMMENDS THE USE OF MICRO-FIT TEST PLUG, SERIES NO. 44242-***** WHENEVER TESTING IS PERFORMED. TEST PLUGS MUST NOT BE USED FOR MAKE OR BREAK UNDER LOAD. MOLEX DOES NOT RECOMMEND USING STANDARD MATING COMPONENTS FOR HARNESS TESTING PURPOSES.
 - SOME HOUSINGS MAY HAVE A SMALL GATE BLEMISH NEAR THE GATE THAT DOES NOT AFFECT FUNCTIONALITY.
 - HOUSINGS HAVE EITHER AN IDENTIFIER RIB OR ENGRAVED '1' SYMBOL TO INDICATE CIRCUIT #1. IDENTIFIER TYPE IS TOOL DEPENDENT AND NOT SELECTABLE.
 - DIMENSION 'A' MEASURED AT DATUM \square -A-
 - THIS PART CONFORMS TO CLASS 'B' REQUIREMENTS OF COSMETIC SPECIFICATION PS-45499-002.

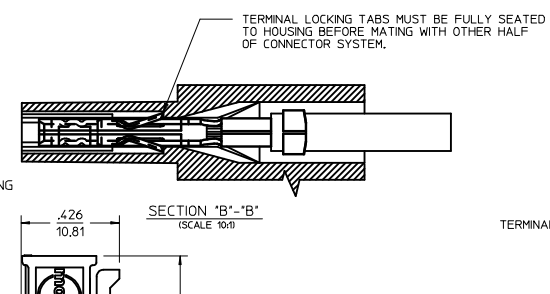
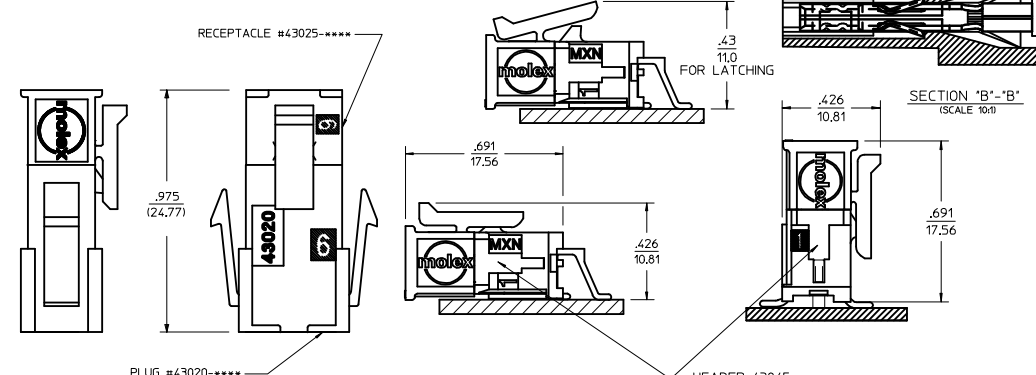
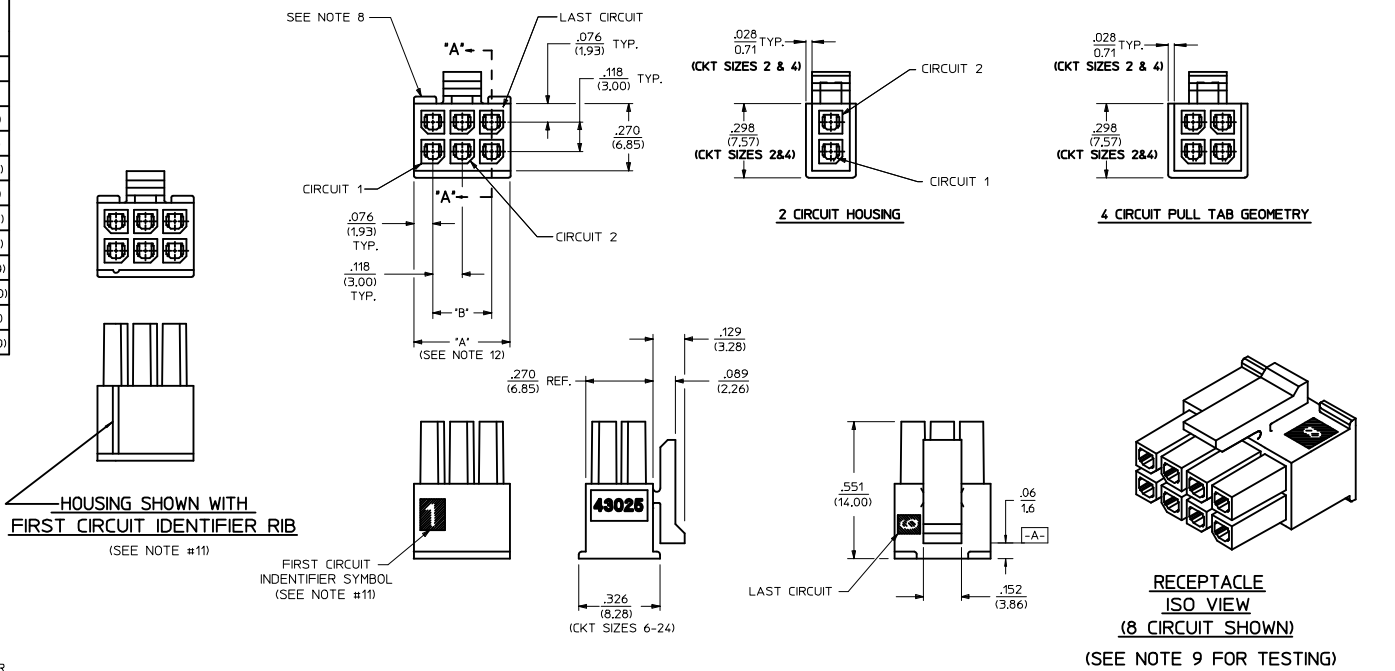

| ADD MATED VIEW LEC NO: UCP2016-4677 DRAWN BY: DRYNAPPELDORN CHKD: DFOX APPROVED: FSMITH | QUALITY SYMBOLS ▽=0 ▽=0 ▽=0 | GENERAL TOLERANCES (UNLESS SPECIFIED) | | DIMENSION STYLE | | SCALE | DESIGN UNITS | THIRD ANGLE PROJECTION |
|---|--------------------------------------|--|-------|---|--------------|--------|--------------|------------------------|
| | | mm | INCH | IN/MM | | METRIC | ☉ | |
| | | 4 PLACES ±.010 | ±.010 | DRAWN BY | DATE | | | |
| | | 3 PLACES ±.025 | ±.014 | CHECKED BY | DATE | | | |
| | | 1 PLACE ±.035 | ±.014 | APPROVED BY | DATE | | | |
| | | 0 PLACE ±.--- | ±.--- | DATE | | | | |
| | | ANGULAR ±1/2° | | MATERIAL NO. | DOCUMENT NO. | | | |
| | | DRAFT WHERE APPLICABLE MUST REMAIN WITHIN DIMENSIONS | | SEE CHART | | | | |
| | | | | THIS DRAWING CONTAINS INFORMATION THAT IS PROPRIETARY TO MOLEX INCORPORATED AND SHOULD NOT BE USED WITHOUT WRITTEN PERMISSION | | | | |

MATED MICRO-FIT CONNECTOR

RECEPTACLE ISO VIEW (8 CIRCUIT SHOWN) (SEE NOTE 9 FOR TESTING)