

Rev	AMEND	DATE	CHECK	APPR.
P1	Proto	2017.12.08	H.I.Woo	H.Y.Sohn
P2	Changed Model Name INC-2703FHRNIG ----> 150LGZ700	2018.01.03	H.I.Woo	H.Y.Sohn
P3	Changed Main Frame Size H : 663 --> 660mm / V : 410 --> 407mm	2018.02.05	H.I.Woo	H.Y.Sohn
P4	Changed Frame Total thickness 57.3mm --> 51.0mm	2018.05.10	H.I.Woo	H.Y.Sohn
P5	Changed I/O Port Name RGB Input ----> VGA Input	2018.05.28	H.I.Woo	H.Y.Sohn

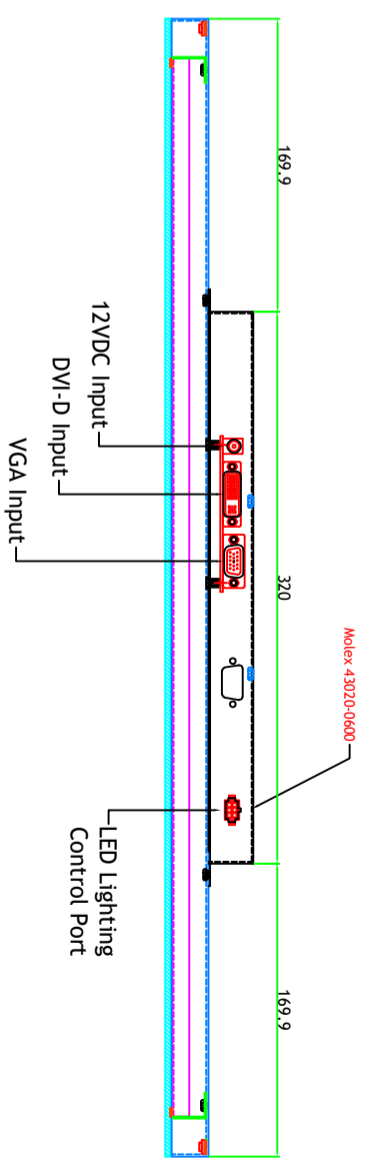
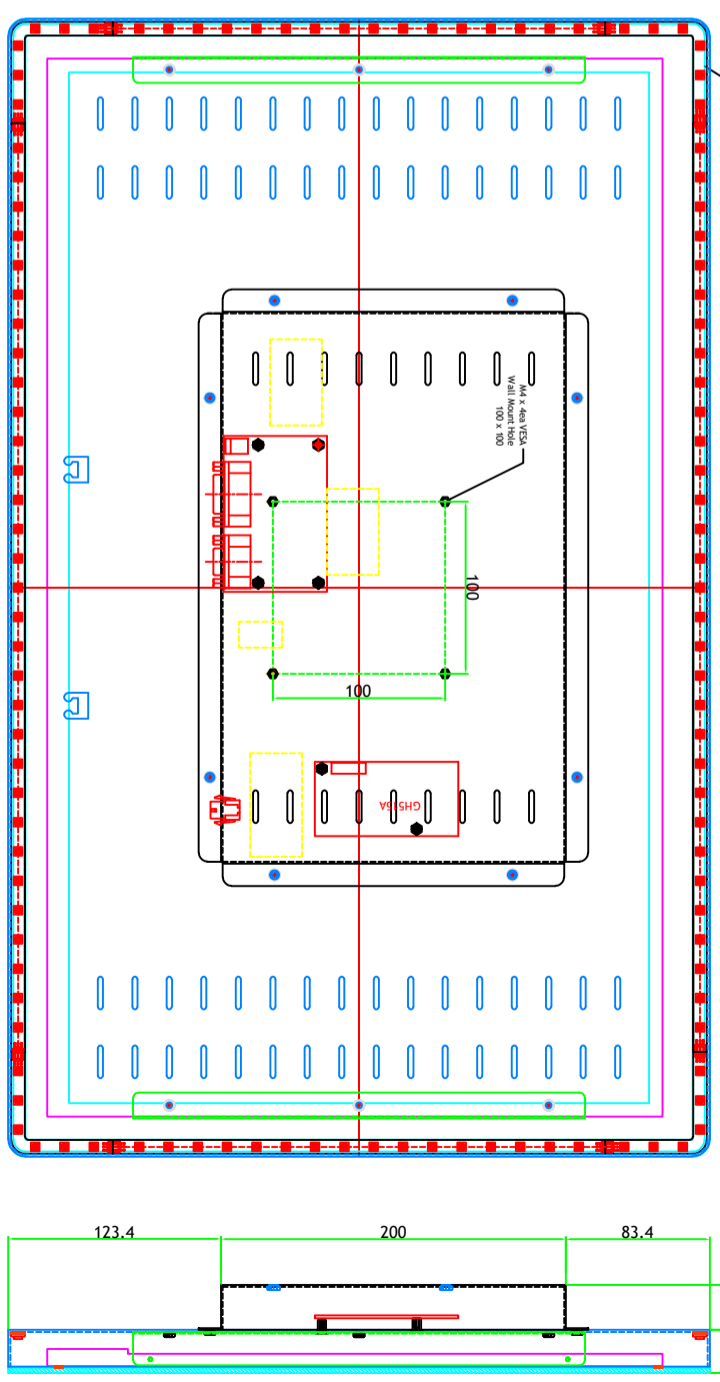
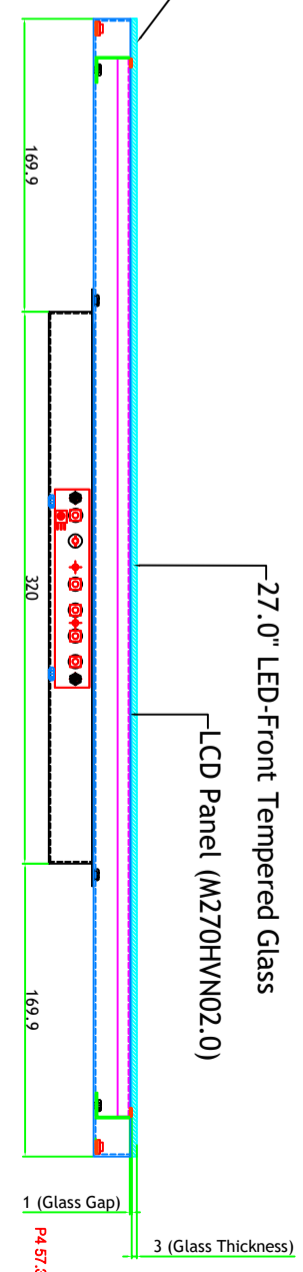
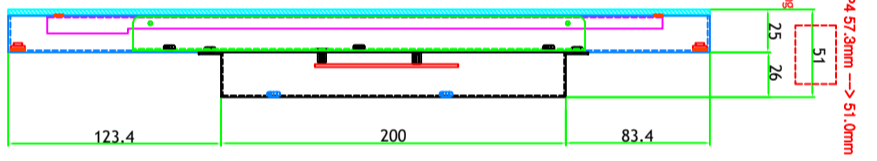
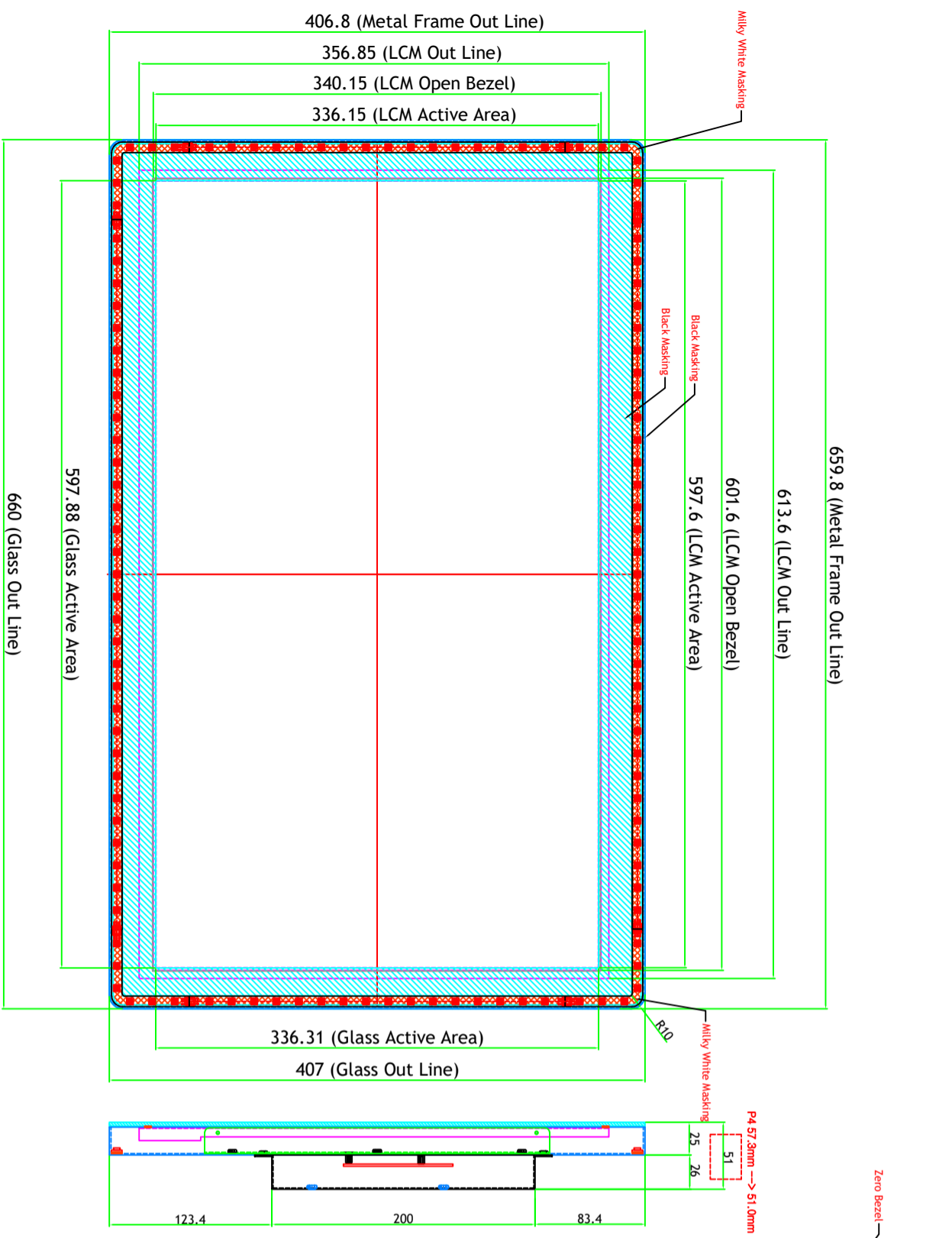

LED Lighting Control Port Pin Map (w/o IC)

#1 : Red , #2 : Green , #3 : Blue

#4 : VCC 12V , #5 : GND , #6 NC

Molex 43020-0600

		MODEL NO	150LGZ700	VIEW :		UNIT :	mm
		NAME	27.0" Closed Frame	Qty		1	
DRAWN	CHECKED	APPROVED	DWG. NO	4M2703034-04	SCALE	1 / 1	
H.I.Woo		H.Y.Sohn	MATERIAL / FINISH	EGI T=1.2	DATE	2019.05.28	

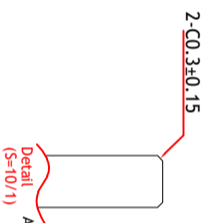

Rev	AMEND	DATE	CHECK	APPR.
P1	Proto	2017.12.08	H.I.Woo	H.Y.Sohn
P2	Changed Model Name INC-2703FHRNIG ---> 150LG2700	2018.01.03	H.I.Woo	H.Y.Sohn
P3	Changed Main Frame Size H : 663 --> 660mm / V : 410 --> 407mm	2018.02.05	H.I.Woo	H.Y.Sohn
P4	Changed Frame Total thickness 57.3mm --> 51.0mm	2018.05.10	H.I.Woo	H.Y.Sohn
P5	Changed I/O Port Name RGB Input ---> VGA Input	2018.05.28	H.I.Woo	H.Y.Sohn

Front View

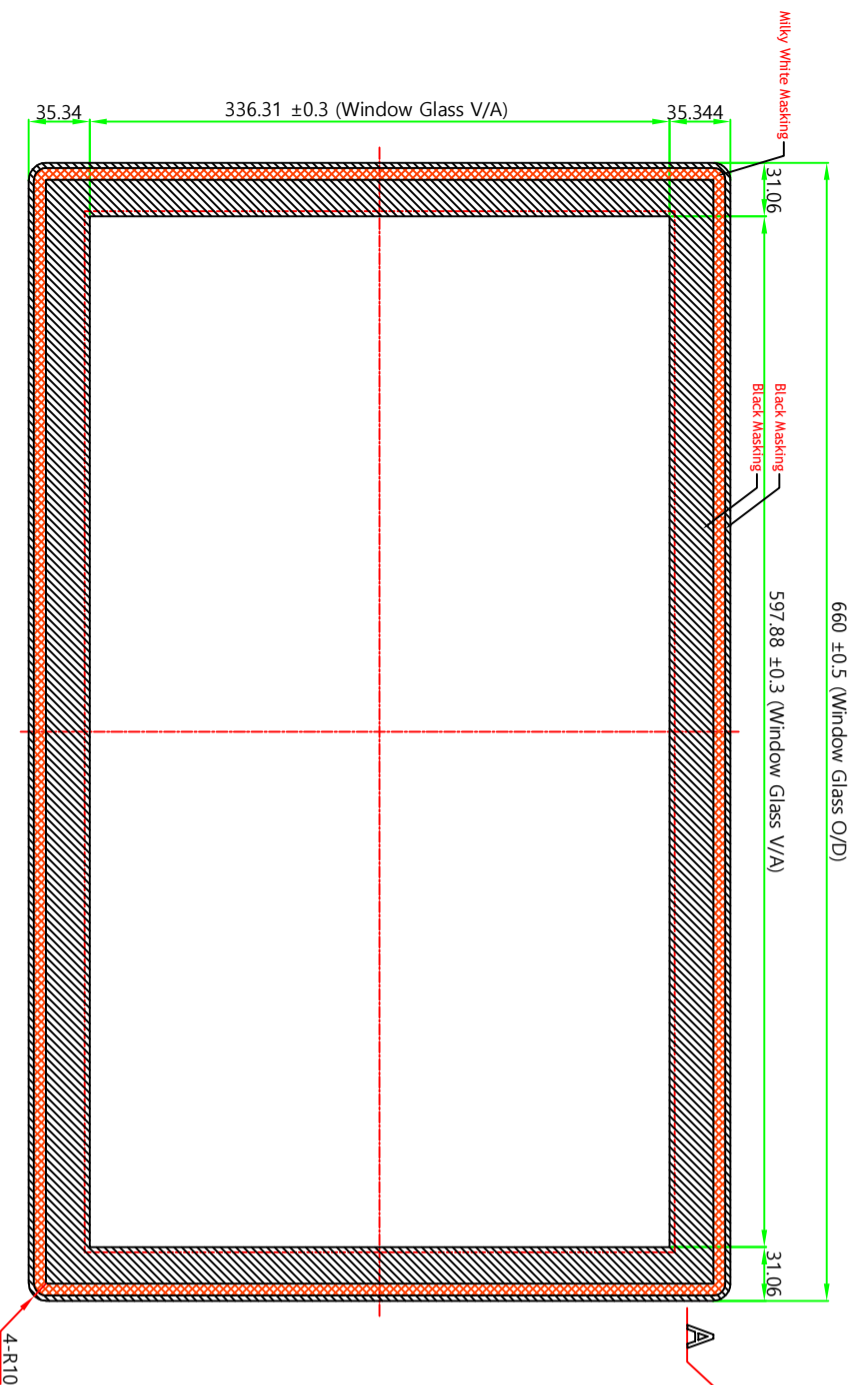

Rear View

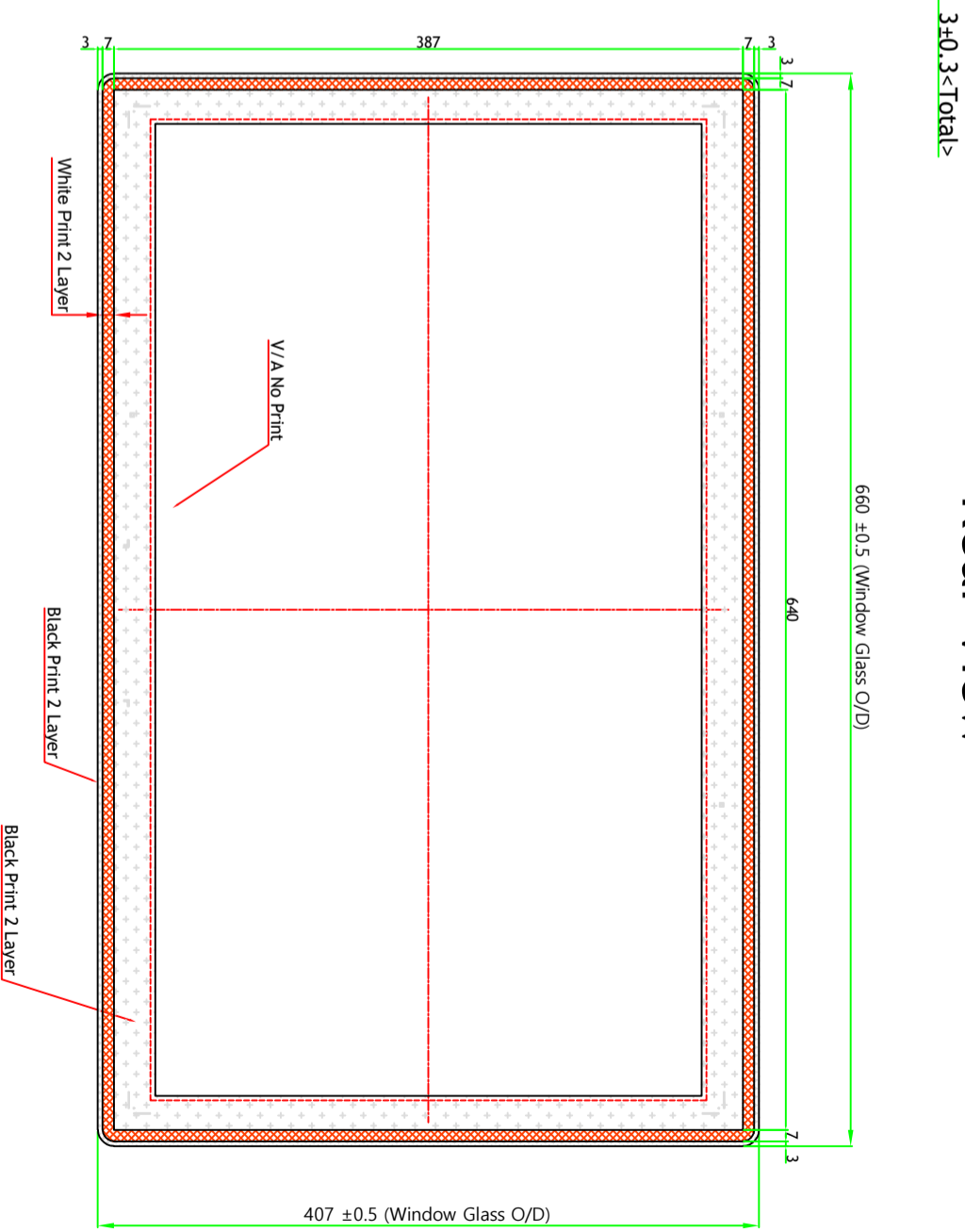

- Black Masking : 2 time
- Milky White Masking : 2 time
- Touch Align Mark : 1 time

PGLSHT2703005 27.0" LED-Front Model Glass Drawing

		MODEL NO	150LG2700		VIEW :			UNIT :	mm	
		NAME	27.0" Closed Frame		Qty	1		REV.	P5	
DRAWN	CHECKED	APPROVED	DWG. NO	4M2703034-04		SCALE	1 / 1			
H.I.Woo		H.Y.Sohn	MATERIAL / FINISH	EGI T=1.2		DATE	2019.05.28			