

MODEL : 150DLP4346

Zero Bezel with PCAP Touchscreen
 LED Illumination on Edge and Front, 4 Sides
 5V Addressable LEDs, w/ IC

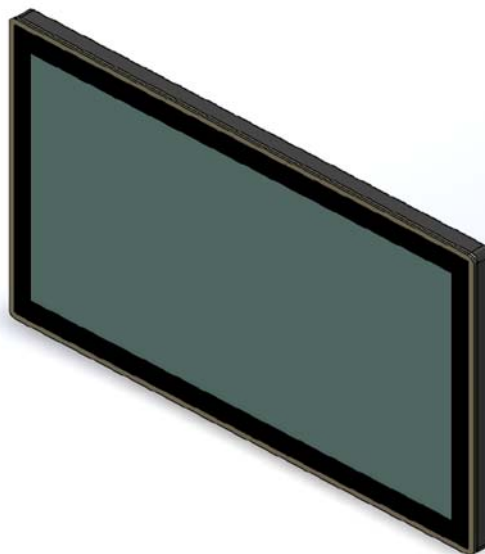

Revision	Date	History
V0.1	2019.07.09	Initial Release.
V1.0	2019.07.17	Added LED Lighting Control Port Slave 5V and GND

Draft _____

Date : _____

Checked: _____

Date : _____

Approved : _____

Date : _____

Contents

1. General Description

- 1.1 Overview
- 1.2 General Specifications
- 1.3 Environmental and Reliability Specification
- 1.4 Power Supply Rating
- 1.5 Input/Output Port

2. User Control & OSD

- 2.1 Key Control Board
- 2.2 OSD Control Function

3. Connector Description

- 3.1 Summary
- 3.2 DP 2: DP (Display Port) Input Jack
- 3.3 DP 1: DP (Display Port) Input Jack
- 3.4 HDMI 2: HDMI Input Jack
- 3.5 HDMI 1: HDMI Input Jack
- 3.6 J6: 24VDC Input Jack
- 3.7 J9: 12VDC Input Jack (Optional)
- 3.8 J13: Main Power/ SMPS Power Input Connector
- 3.9 J12: Backlight Inverter Connector
- 3.10 J14: 12VDC/5VDC Power Output Connector
- 3.11 J16: Panel Power Connector
- 3.12 J8: Auto Dimming/RS232 Connector
- 3.13 CNF3: V-by-One Output Connector
- 3.14 J17: eDP Output Connector
- 3.15 J15: OSD Board Connector

4. Standard Display Modes

5. LED Backlight Driver Board Specification

6. Board Dimensions

7. LED Lighting Control Specification

8. Touchscreen Specification

9. Packing Information

10. Mechanical Structure

1. General Description

1.1 Overview

- ◆ SUZOHAPP Closed-frame LCD Monitor 150DLP4346 is a high performance TFT LCD monitor providing a high quality screen image.
- ◆ This monitor supports HDMI and DP input. Other input options are available.
- ◆ Wide input resolution range up to UHD (3840 x 2160@60Hz).
- ◆ It is designed for industrial use with Auto power on, up scaling performance adequate for low-resolution applications and enhanced design margin for reliability.
- ◆ It is available in matching touch and non-touch designs.

1.2 General Specifications

LCD Panel	Size	42.5" Diagonal
	Active Display Area	941.184mm(H) x 529.416mm(V)
	Type No.	AUO P430QVN01.0
	Number of Pixels	3840 (H) x 2160 (V)
	Pixel Arrangement	RGB Vertical Stripe
	Pixel Pitch	0.2451mm x 0.2451mm
	Color Depth	1.07B True Colors
	Surface Treatments	Anti-Glare Haze 44%, Hard –coating (3H)
	Viewing Angle (CR>10)	R/L: 178 degree (89/89) U/D: 178 degree (89/89)
	Contrast Ratio	Typ. 4000 : 1
	Response Time(Typ.)	8ms
	Average Brightness	Typ. 500 cd/ m ²
	Frame Rate	Typ. 60Hz
	Backlight Unit	LED
Input Resolution	Prime	3840 x 2160@60Hz
	Standard	800x600 @60/72/75 Hz, 1024x768 @60/70/75 Hz, 1280x1024 @75 Hz, 1366x768@60Hz, 1440x900@60Hz, 1680x1050@60Hz, 1920x1080@60Hz, 1920x1200@60Hz 2560x 1600@60Hz, 3840x2160@60Hz

Input Signal Port	HDMI 2.0	19pin HDMI Jack x 2 Port
	DP(Display Port) 1.2	15pin DP Jack x 2 Port
	Power Jack	Power Mini-Din 4P x 1 Port
Scanning Frequency	Horizontal	30 ~130Khz
	Vertical	55 ~75Hz
OSD Control		Menu, Select, Up, Down, Power
Plug & Play		VESA DDC 2B Ver1.3
Touchscreen	Touch Panel	P-CAP Touch : 43.0" Edge-Lit Touch / 10 Point (ITIC-430-xxA)
	Controller	SIW3C3249
	Controller Interface	USB 2.0 Type "B"
LED Frame Illumination (Without Controller)		Edge / Front Type, 4 sided
		LED Type : Dual Line w/IC type (BT5050B)
		Supports External 5V Addressable, w/IC type LED Lighting Controller
		Interface Port : Molex 43020-0600
RoHS		RoHS2 Compliance
Mounting Options		400(H) x 200(V)mm M6 VESA Mounting Holes
Optional Accessories		Cables, Power Supply <for Addressable style, also say LED Lighting Controller>

Application Caution

- 1. Precautions for strong light exposure.**
Strong light exposure causes degradation of polarizer and color filter.

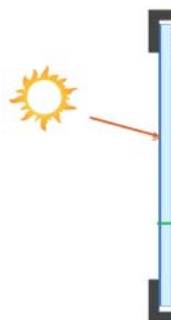

- 2. Using Conditions.**

- Temperature inside the cabinet should be controlled 'at room temp' (0 ~ 40°C) by cooler and fan.

1.3 Environmental and Reliability Specification

- This specification depends on the LCD panel characteristics. Please refer to the manufacturer's panel specification for details.

Item	Symbol	Min	Max	Unit
Operating Temperature	TOP	0	+50	°C
Operating Humidity	HOP	10	90	%
Storage Temperature	TST	-20	+60	°C
Storage Humidity	HST	10	90	%

1.4 Power Supply Rating

Optional PSU Input Voltage	AC 100 ~ 240VAC,50/60Hz			
Optional PSU Output Voltage	DC 24V6.6A			
Monitor DC Input Voltage	24VDC			
Power Consumption	Typ. 96W (24VDC / 4.0A)			
LED String Lighting Specification (5V Addressable, w/IC type)	Min	Typ.	Max	Unit
Input Voltage	4.75	5.0	5.25	[V]
Input Current		TBD		[A]
Power Consumption		TBD		[W]

- Conditions of Measurement
 - 1) LED pattern: LED Bar full white light, non-scrolling.
 - 2) Current consumption tolerance: + 10%.

1.5 Input/Output Port

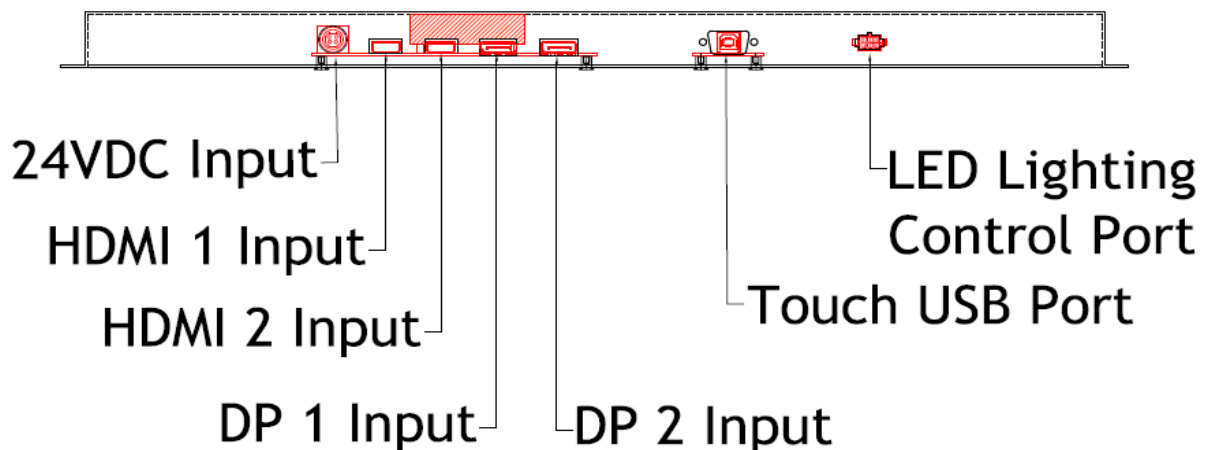

2. User Control & OSD

2.1 Key Control Board

K002

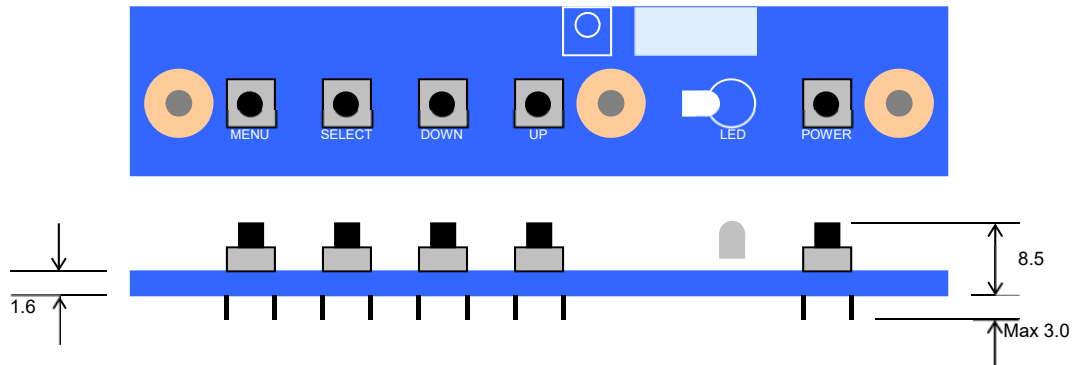

Button	Function	Status	HOT Key
LED	Indicates operation status	Green : Normal State Red : Off Mode Green Blinking : DPMS Mode	
POWER	Power on/off		
MENU	Enable MENU Window Disable MENU Window Exit from Sub function		
SELECT	Select function		No OSD Window, Input Source Change
DOWN	Move to Down or Left		No OSD Window, Auto Color
UP	Move to Up or Right		No OSD Window, Auto Configuration

2.2 OSD Control Function

The chosen OSD settings will be stored in memory. The OSD menu can be cleared from the screen by pressing the **MENU** button otherwise it will be automatically cleared after a few second of non-use.

2.2.1 OSD Main Menu

1) PICTURE

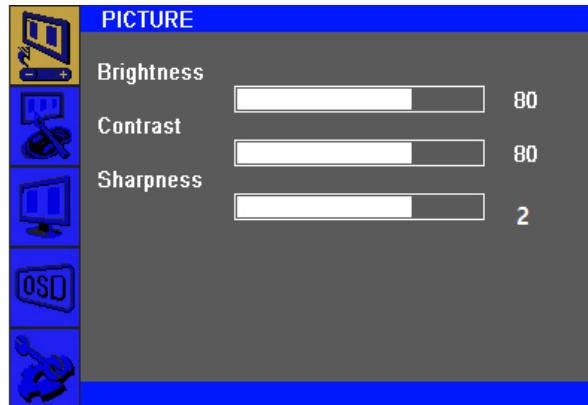

Brightness (0 ~ 100)	Increases/decreases monitor Brightness. Default: 100
Contrast (0 ~ 100)	Increases/decreases monitor Contrast. Default: 100
Sharpness (0 ~ 4)	Adjusts Sharpness of the displayed images. Default : 2

2) COLOR

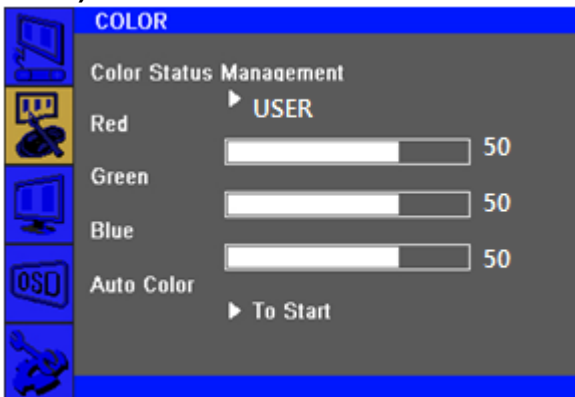

Color Status Management	Selects the display's color temperature. The available color settings "Normal", "Warm", "Cool", "User", "Game" mode. Default : User
Red (0 ~ 100)	Increases/decreases Red Color Temperature. Default : 50
Green (0 ~ 100)	Increases/decreases Green Color Temperature. Default : 50
Blue (0 ~ 100)	Increases/decreases Blue Color Temperature. Default : 50
Auto Color	Automatically adjusts the system color to the input VGA.

3) SCREEN (VGA input only)

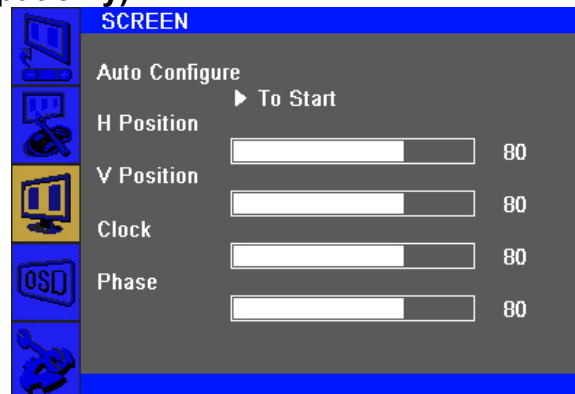

Auto Configure	Automatically adjusts the system clock to the input VGA.
H Position (0 ~ 100)	Moves the image horizontally on the display in single-pixel increments. Default : 50
V Position (0 ~ 100)	Moves the image vertically on the display in single-pixel increments. Default : 50
Clock (0 ~ 100)	Allows fine adjustments of the panel's pixel dot clock. Default : 50
Phase (0 ~ 100)	Allows fine adjustments of the panel's pixel dot clock phase. Default : 50
WXGA Mode	Selects WXGA Mode Off, 1024 x 768, 1280 x 768, 1360 x 768, 1366 x 768 Default : Off

4) OSD

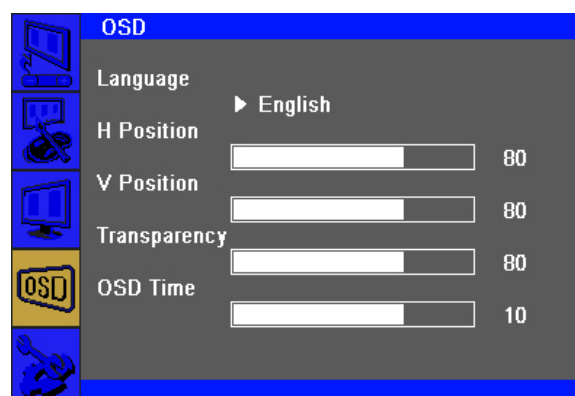

Language	Selects the OSD's display language. The available languages are English, Deutsch, Français, Italiano, Español, Korean. Default : English
H Position (0 ~ 100)	Adjusts the horizontal location of the OSD menus on the display. Default : 50

V Position (0 ~ 100)	Adjusts the vertical location of the OSD menus on the display. Default : 50
Transparency (0 ~ 100)	Adjusts the transparency of the OSD menus on the display. Default : 33
OSD Time (0 ~ 60)	Adjusts how long the touch monitor will wait without OSD button activity before closing the OSD. The adjustable range is between 0 and 60 seconds. Default : 10

5) SETUP

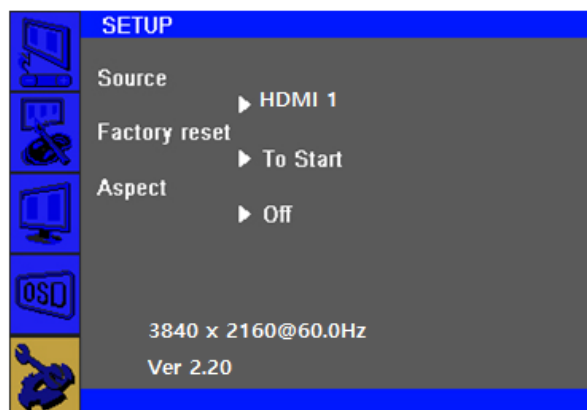

Source	Selects Input Source VGA (RGB), DVI.
Factory reset	Restores all factory default settings for OSD-adjustable parameters and for Preset Video Mode timings.
Aspect	Switches the scaling method between Full Scaling and Maintain Aspect Ratio. Default : Off

6) Input Source



3. Connector Description

3.1 Summary

Reference	Item	Description	Component	Manufacture
DP2	Jack	DP Input Jack	DP	-
DP1	Jack	DP Input Jack	DP	-
HDMI2	Jack	HDMI Input Jack	HDMI-19P	
HDMI1	Jack	HDMI Input Jack	HDMI-19P	
J6	Jack	24VDC Power Input Jack	KPJ-4S-S	
J9	Jack	12VDC Power Input Jack (Optional)	DJ05H-250	
J13	Wafer	Main Power / SMPS Power Input Connector	SMAW250-10	YEON-HO
J12	Wafer	Backlight Inverter Connector	SMAW250-12	YEON-HO
J14	Wafer	12VDC/5VDC External Power Output Connector	SMAW250-06	YEON-HO
J16	Wafer	Panel Power Output Connector	SMAW250-04	YEON-HO
J8	Wafer	Auto-Dimming/RS232 Connector	SMAW200-05	YEON-HO
CNF3	Wafer	V By One Output(8Lane) Connector	FI-RE51S-HF	YEON-HO
J17	Wafer	eDP Output(4Lane/8Lane) Connector	20347-040E	I-PEX
J15	Wafer	OSD Board Connector	12505WR-07	YEON-HO

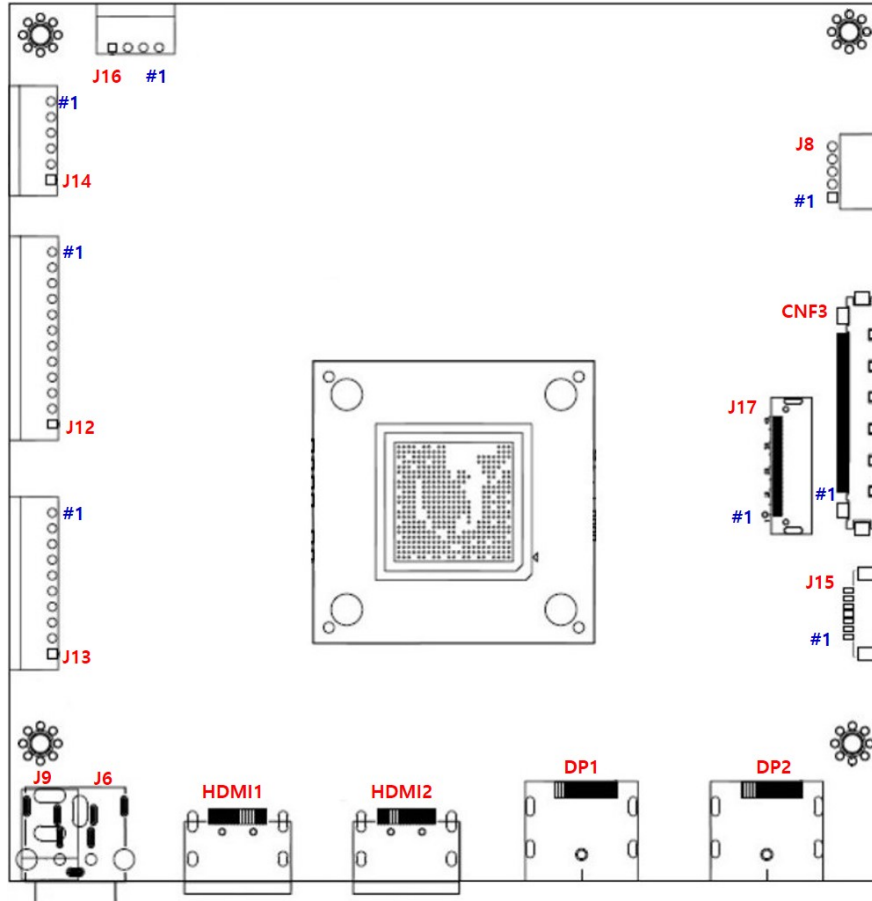

3.2 DP2: DP 1.2 (Display Port) Input Jack



Pin No.	Symbol	Description
1	LANE3-	Component Signal for Main Link 3
3	LANE3+	True Signal for Main Link 3
4	LANE2-	Component Signal for Main Link 2
6	LANE2+	True Signal for Main Link 2
7	LANE1-	Component Signal for Main Link 1
9	LANE1+	True Signal for Main Link 1
10	LANE0-	Component Signal for Main Link 0
12	LANE0+	True Signal for Main Link 0
13	CA DET	No Connection
14	DP DET+	No Connection
15	AUX CH+	True Signal for Auxiliary Channel
17	AUX CH-	Component Signal for Auxiliary Channel
18	+5V Power	Identify the presence of a monitor
19	RETURN	No Connection
20	PWR OUT	No Connection
16	GND	Ground

3.3 DP1: DP 1.2 (Display Port) Input Jack

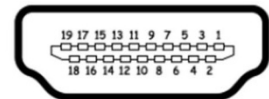

Pin No.	Symbol	Description
1	LANE3-	Component Signal for Main Link 3
3	LANE3+	True Signal for Main Link 3
4	LANE2-	Component Signal for Main Link 2
6	LANE2+	True Signal for Main Link 2
7	LANE1-	Component Signal for Main Link 1
9	LANE1+	True Signal for Main Link 1
10	LANE0-	Component Signal for Main Link 0
12	LANE0+	True Signal for Main Link 0
13	CA DET	No Connection
14	DP DET+	No Connection
15	AUX CH+	True Signal for Auxiliary Channel
17	AUX CH-	Component Signal for Auxiliary Channel
18	+5V Power	Identify the presence of a monitor
19	RETURN	No Connection
20	PWR OUT	No Connection
16	GND	Ground

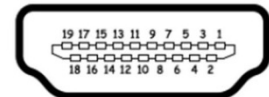
3.4 HDMI2: HDMI 2.0 Input Jack

Pin No.	Symbol	Description
1	TMDS DATA2+	TMDS DATA2 Differential Positive Signal
2	GND	Ground
3	TMDS DATA2-	TMDS DATA2 Differential Negative Signal
4	TMDS DATA1+	TMDS DATA1 Differential Positive Signal
5	GND	Ground
6	TMDS DATA1-	TMDS DATA1 Differential Negative Signal
7	TMDS DATA0+	TMDS DATA0 Differential Positive Signal
8	GND	Ground
9	TMDS DATA0-	TMDS DATA0 Differential Negative Signal
10	TMDS CLOCK+	TMDS CLOCK Differential Positive Signal
11	GND	Ground
12	TMDS CLOCK-	TMDS CLOCK Differential Negative Signal
13	CEC	CEC Function
14, 17	NC	No Connection
15	DDC Clock	DDC Clock Signal
16	DDC data	DDC Data Signal
18	+5V Power	+5V Power
19	HPD	Hot Plug Detection

3.5 HDMI1: HDMI 2.0 Input Jack

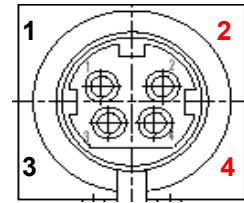
Pin No.	Symbol	Description
1	TMDS DATA2+	TMDS DATA2 Differential Positive Signal
2	GND	Ground
3	TMDS DATA2-	TMDS DATA2 Differential Negative Signal
4	TMDS DATA1+	TMDS DATA1 Differential Positive Signal
5	GND	Ground
6	TMDS DATA1-	TMDS DATA1 Differential Negative Signal
7	TMDS DATA0+	TMDS DATA0 Differential Positive Signal
8	GND	Ground
9	TMDS DATA0-	TMDS DATA0 Differential Negative Signal
10	TMDS CLOCK+	TMDS CLOCK Differential Positive Signal
11	GND	Ground
12	TMDS CLOCK-	TMDS CLOCK Differential Negative Signal
13	CEC	CEC Function
14, 17	NC	No Connection
15	DDC Clock	DDC Clock Signal
16	DDC data	DDC Data Signal
18	+5V Power	+5V Power
19	HPD	Hot Plug Detection

3.6 J6: 24V Power Input Jack (Optional)

Pin No.	Symbol	Description
1,3	GND	Ground
2,4	VCC	24VDC

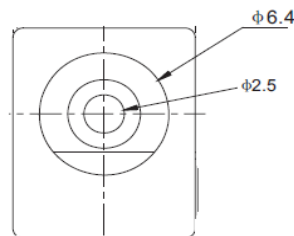
3.7 J9 : 12V Power Input Jack (Optional)

Pin No.	Symbol	Description
-	GND	Ground
+	VCC	12VDC

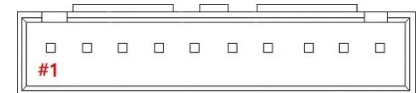
3.8 J13: Main Power / SMPS Power Connector

Pin No.	Symbol	Description
1, 2, 3, 4, 5	VCC	24VDC
6, 7, 8, 9,10	GND	Ground

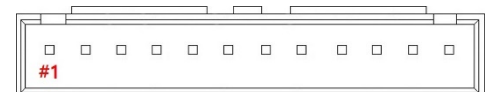
3.9 J12: Backlight Inverter Connector

Pin No.	Symbol	Description
1, 2, 3, 4, 5	VCC	24VDC
6, 7, 8, 9,10	GND	Ground
11	INVERTER ON/OFF	Inverter On(3.3V) / Off(0V) Signal
12	DIM-ADJUST	DIM-adjustment analog dimming control signal. * make sure inverter specification

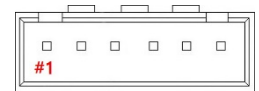
3.10 J14: 12VDC / 5VDC External Power Output Connector

Pin No.	Symbol	Description
1, 2, 3	+12V	12VDC Output
4	+5V	5VDC Output
5,6	GND	Ground

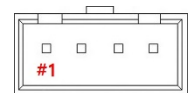
3.11 J16: Panel Power Output Connector

Pin No.	Symbol	Description
1, 2	PANEL_VDD	12VDC Output for Panel or FRC Power
3, 4	GND	Ground

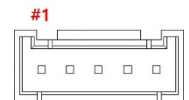
3.12 J8: Auto-Dimming / RS232 Connector

Pin No.	Symbol	Description
1	VCC	+5V Power for RS232
2	CDS	Light Sensor Input
3	TXD	RX232 TX
4	RXD	RX232 RX
5	GND	Ground

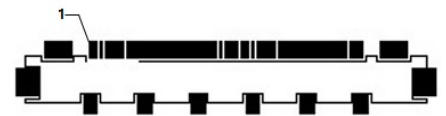
3.13 CNF3: V By One Output (8Lane) Connector

Pin No.	Symbol	Description
1	GND	Ground
2	VTX_TX7P	VTX_TX7P
3	VTX_TX7N	VTX_TX7N
4	GND	Ground
5	VTX_TX6P	VTX_TX6P
6	VTX_TX6N	VTX_TX6N
7	GND	Ground
8	VTX_TX5P	VTX_TX5P
9	VTX_TX5N	VTX_TX5N

10	GND	Ground
11	VTX_TX4P	VTX_TX4P
12	VTX_TX4N	VTX_TX4N
13	GND	Ground
14	VTX_TX3P	VTX_TX3P
15	VTX_TX3N	VTX_TX3N
16	GND	Ground
17	VTX_TX2P	VTX_TX2P
18	VTX_TX2N	VTX_TX2N
19	GND	Ground
20	VTX_TX1P	VTX_TX1P
21	VTX_TX1N	VTX_TX1N
22	GND	Ground
23	VTX_TX0P	VTX_TX0P
24	VTX_TX0N	VTX_TX0N
25	GND	Ground
26	VTX_PLL_Lock	VTX_PLL_Lock
27	VTX_HPD	V-by-One Hot Plug Detect
28	GND	Ground
29	V-by-one Bit Select	V-by-One 8bit/10bit Select
30	NC	LED Enable(Optional)
31	GND	No Connection
32	SDA	V-by-One IICSDA
33	SCL	V-by-One IIC SCL
34	NC	No Connection
35	AUX_CH_P2	AUX_CH_P2
36	AUX_CH_N2	AUX_CH_N2
37	GND	Ground
38	AUX_CH_P1	AUX_CH_P1
39	AUX_CH_N1	AUX_CH_N1
40, 41, 42	GND	Ground
43	NC	No Connection
44, 45, 46, 47, 48, 49, 50, 51	PANEL_VDD	12VDC Output for Panel

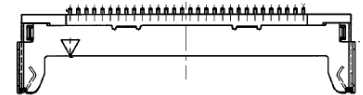
3.14 J17: eDP Output(4Lane/8Lane) Connector

Pin No.	Symbol	Description
1, 2, 3	PANE_VDD	12VDC Output for Panel
4	NC	No Connection
5,6,7	GND	Ground
8, 9, 10	NC	No Connection
11	eDP1_HPDP	TX HPD1
12	2 nd _AUXP	2 nd TX_AUX_P
13	2 nd _AUXN	2 nd TX_AUX_N
14	GND	Ground
15	DPTX_L7P	DPTX_L7P
16	DPTX_L7N	DPTX_L7N
17	GND	Ground
18	DPTX_L6P	DPTX_L6P
19	DPTX_L6N	DPTX_L6N
20	GND	Ground
21	DPTX_L5P	DPTX_L5P
22	DPTX_L5N	DPTX_L5N
23	GND	Ground
24	DPTX_L4P	DPTX_L4P
25	DPTX_L4N	DPTX_L4N
26	eDP0_HPDP	TX HPD0
27	1 st _AUXP	1 st TX_AUX_P
28	1 st _AUXN	1 st TX_AUX_N
29	GND	Ground
30	DPTX_L3P	DPTX_L3P
31	DPTX_L3N	DPTX_L3N
32	GND	Ground
33	DPTX_L2P	DPTX_L2P
34	DPTX_L2N	DPTX_L2N
35	GND	Ground
36	DPTX_L1P	DPTX_L1P
37	DPTX_L1N	DPTX_L1N
38	GND	Ground
39	DPTX_L0P	DPTX_L0P
40	DPTX_L0N	DPTX_L0N

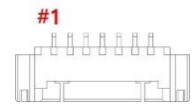
3.15 J15: OSD Controller Connector

Pin No.	Symbol	Description
1	VCC	+5V Power for IR sensor
2	IRQ	Infrared rays signal line.
3	LED1	Green LED
4	LED2	Red LED
5	GND	Ground
6	ADC-IN0	Menu, Up
7	ADC-IN1	Power, Down, Up

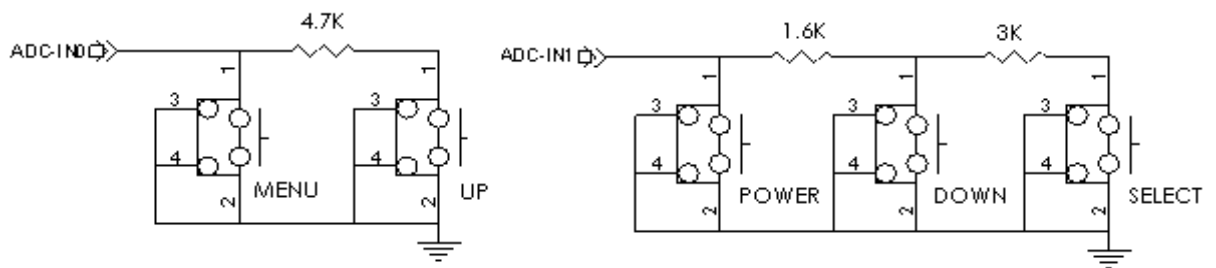

4. Standard Display Modes

Spec Mode	Pixel Freq.	Horizontal Timing				Vertical Timing			
		Sync Polar	Freq.	Total	Active	SP	Freq.	Total	Active
	MHz		KHz	Pixel	Pixel		Hz	Line	Line
640*350@70Hz	25.144	P	31.430	800	640	N	70.000	449	350
640*400@70Hz	28.287	N	31.430	800	640	P	70.000	449	400
720*400@ 70Hz	28.287	N	31.430	900	720	P	70.000	449	400
640*480@60Hz	28.175	N	31.469	800	640	N	59.940	525	480
640*480@72Hz	31.500	N	37.861	832	640	N	72.809	520	480
640*480@75Hz	31.500	N	37.500	840	640	N	75.000	500	480
800*600@56 Hz	36.000	P	35.156	1024	800	P	56.250	625	600
800*600@60Hz	40.000	P	37.879	1056	800	P	60.317	628	600
800*600@72Hz	50.000	P	48.077	1040	800	P	72.188	666	600
800*600@75Hz	49.500	P	46.875	1056	800	P	75.000	625	600
1024*768@60Hz	65.000	N	48.363	1344	1024	N	60.005	806	768
1024*768@ 70Hz	75.000	N	56.476	1328	1024	P	70.070	806	768
1024*768@75Hz	78.750	P	60.023	1312	1024	P	75.030	800	768
1280*720@60Hz	74.500	P	44.772	1664	1280	P	59.855	748	720
1280*768@60Hz	68.250	P	47.396	1440	1280	N	59.995	790	768
1360*768@60Hz	84.75	P	47.72	1776	1360	P	59.799	798	768
1280*1024@60Hz	108.000	P	63.981	1688	1280	P	60.020	1066	1024
1280*1024@75Hz	135.000	P	79.976	1688	1280	P	75.035	1066	1024
1440*1050@60Hz	101.000	P	64.744	1560	1400	N	59.948	1080	1050
1680*1050@60Hz	119.125	P	64.742	1840	1680	N	59.946	1080	1050
1600*1200@60Hz	162,000	P	75,000	2160	1600	P	60.00	1250	1200
1920*1080@60Hz	138.625	P	66.647	2080	1920	N	59.988	1111	1080
1920*1200@60Hz	154.125	P	74.099	2080	1920	N	59.999	1235	1200
2560*1600@60Hz	268.500	P	98.713	2720	2560	N	60.010	1641	1600
3840*2160@60Hz	585.980		129.600	4480	3840		60.000	2180	2160

5. LED Backlight Driver Board Specification

5.1 Electrical Specification

	Item	Symbol	Condition	Spec			Unit	Note	
				Min	Typ	Max			
1	Input Voltage	V _{DDB}	-	22.8	24	25.2	VDC	-	
2	Input Current	I _{DDB}	V _{DDB} =24V		3.06 (TBD)	3.31 (TBD)	ADC	1	
3	Input Power	P _{DDB}	V _{DDB} =24V		73.5 (TBD)	79.5 (TBD)	W	1	
4	Inrush Current	I _{RUSH}	V _{DDB} =24V		-	1.2	ADC	2	
5	On/Off control voltage	V _{B_{LON}}	ON	2 0	3.3	5.5	VDC	-	
			OFF		0.8	0.8		0.8	-
6	On/Off control current	I _{B_{LON}}	V _{DDB} =24V	-	-	1.5	mA	-	
7	External PWM Control Voltage	V _{EPWM}	MAX	2	-	5.5	VDC	-	
			MIN	0	-	0.8		0.8	-
8	External PWM Control Current	I _{EPWM}	V _{DDB} =24V	-	-	2	mADC	-	
9	External PWM Duty ratio	D _{EPWM}	V _{DDB} =24V	5	-	100	%	3	
10	External PWM Frequency	F _{EPWM}	V _{DDB} =24V	90	180	240	Hz	-	
11	DET status signal	DET	HI	Open Collector	Open Collector			VDC	4
			Lo		0.8	0.8	0.8	VDC	4
12	Input Impedance	R _{in}	V _{DDB} =24V	300			Kohm	-	

5.2 Interface

5.2.1 CN1 Connector: 20010WR-14 (YeonHo) or EQ

Pin	Symbol	Remarks
1,2,3,4,5	V _{in}	Input Voltage 24VDC
6,7,8,9,10	GND	GND
12	On/Off	Backlight On/Off (5V:On, 0V : Off)
14	PDIM	External PWM

6. Board Dimensions

6.1 AD Board (INB3000 V2) Dimension (140mm x 140mm x 21.6mm)

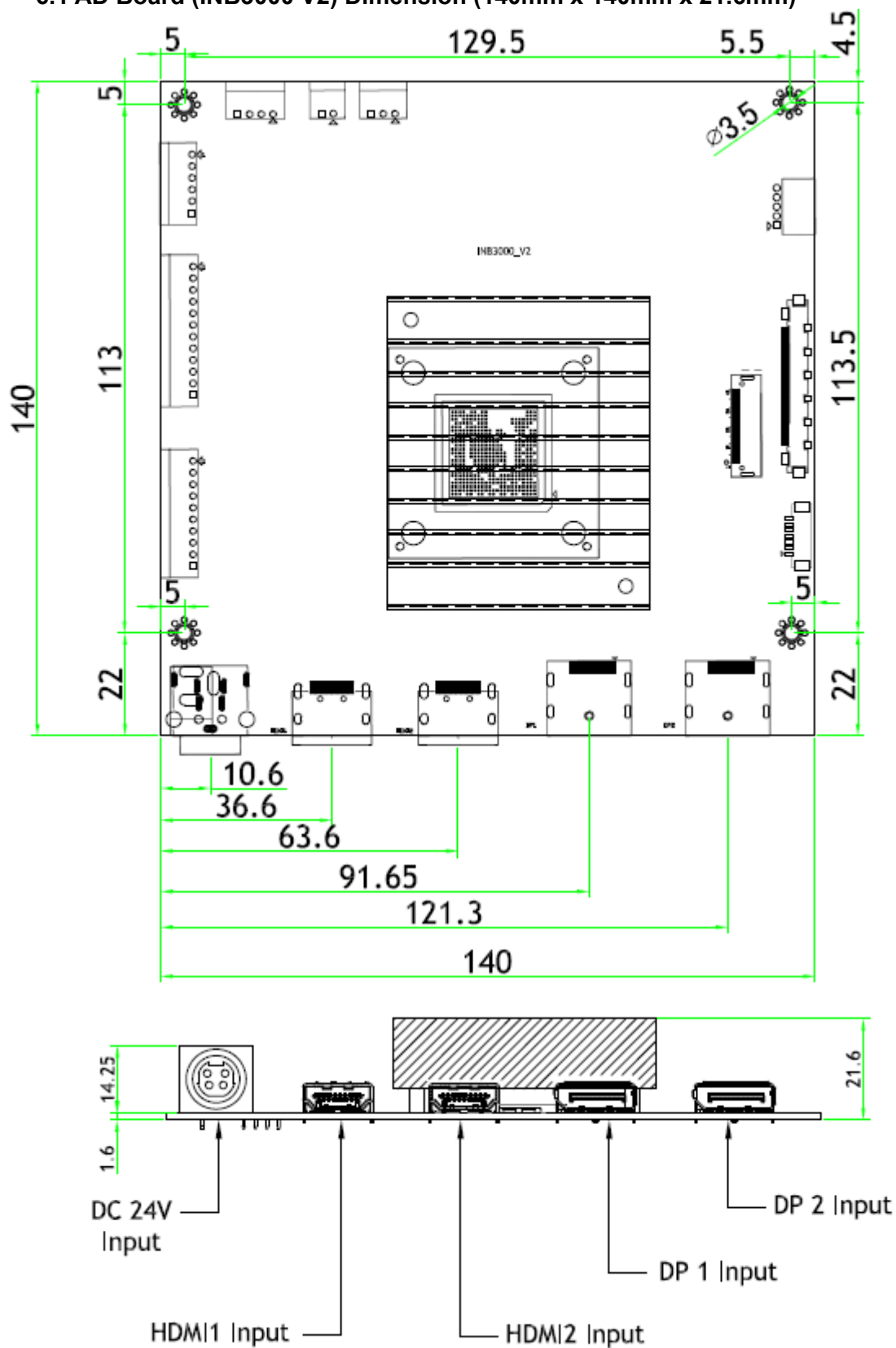

6.2 OSD Board (K002) Dimension (115mm x 20mm x 8.7mm)

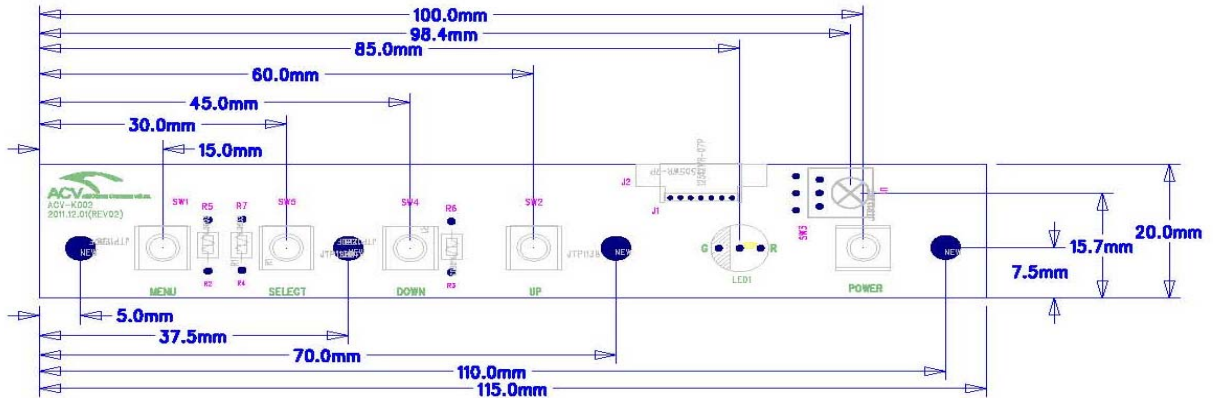

7. LED Lighting Control Interface Specification

7.1 Connector Spec

- Connector: Molex 43020-0600

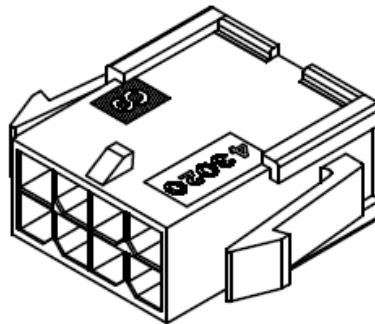

- Matching Housing: Molex 43025-0600

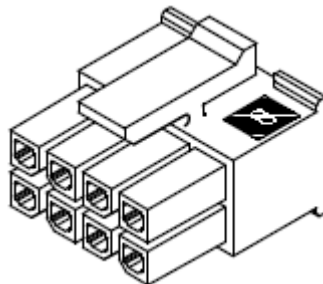

7.2 External LED Connector Pin Map

7.2.1 With IC (Dual-Line) LED Bar Board

LED Lighting Control Port Pin Map (w/ IC)

#1 : 5V, #2 : CTL, #3 : GND
 #4 : 5V, #5 : NC, #6 : GND

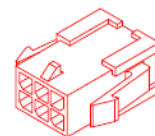
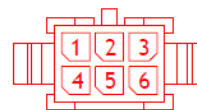

Molex 43020-0600

Pin No	Symbol	Remark
1	5V	DC 5V (Master)
2	CTL	With IC LED Control Line
3	GND	GND
4	5V	DC 5V (Slave)
5	NC	Non Connection
6	GND	GND

7.3 LED (BT5050B) Spec

7.3.1 LED (BT5050B) Pin Configuration

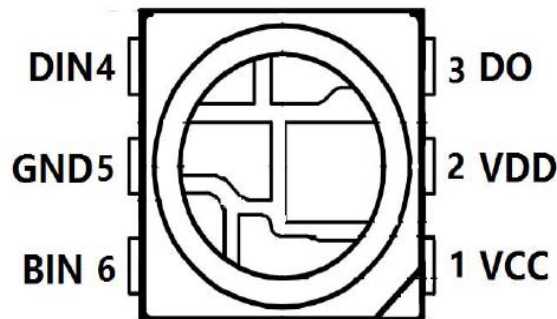

PIN Function

NO.	Symbol	PIN	Function description
1	VCC	VCC	IC POWER SUPPLY
2	VDD	VDD	LED POWER SUPPLY, connect to "+5V"
3	DO	DO	Control data signal output
4	DIN	DIN	Control data signal input
5	GND	GND	Data & Power Grounding
6	BIN	BIN	Backup Control data signal input

7.3., LED (BT5050B) Circuit

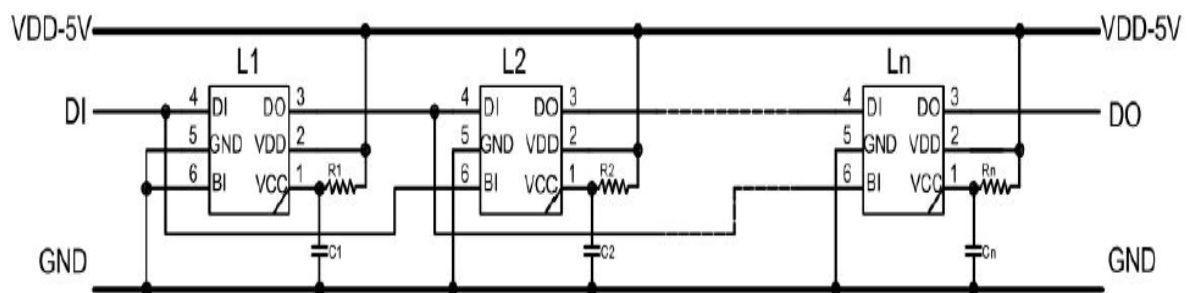

8. P-CAP Touchscreen Specification

8.1. Specifications

Item	Spec.	Remark
Performance	Number of Touch Point	10
	Input Method	Finger
	Numbers of Max Channels	TX : 66, RX : 116
	Position resolution	4096 X 4096 (12Bit)
	Interface	USB (HID)
Reliability	Accuracy	99 %
	ESD Protection	Contact: ±8kV, Air: ±15kV
	Operating Temperature	-10°C ~ 60°C
	Storage Temperature	-20°C ~ 70°C
Mechanical	Warranty	1 year
	Horizontal length	130 mm (±0.5 mm)
	Vertical length	50 mm (±0.5 mm)
Firmware	Height	4.6 mm(±0.5 mm)
	SIW FW Version	TBD
	VID/PID	29BD/4101
	Controller Version	TBD

8.2 Touch Control Board Dimension (130.0mm x 50.0mm)

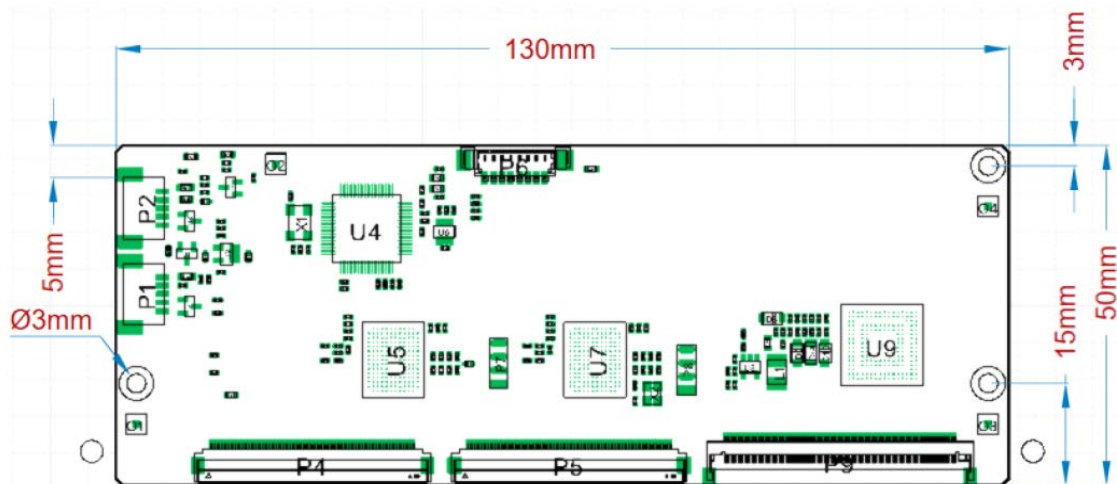

8.2.1 Touch Control Board USB Interface

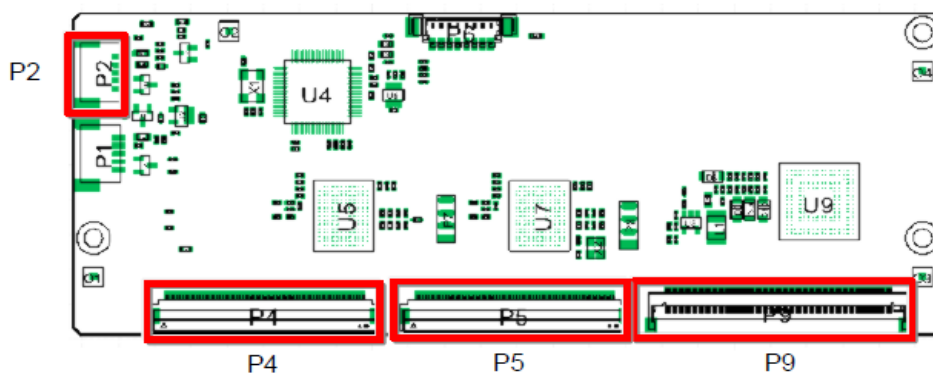

P2 : USB Connection

Pin Number	Description
1	GND
2	VBUS (+5V)
3	GND
4	Data (DP)
5	Data (DN)

Part NO : YEONHO 12507WR-05L

8.3. USB Connector (USB 2.0, Type “B”)

Number	Signal Name
1	+5V
2	D-
3	D+
4	GND

8.3.1 USB Interface Port

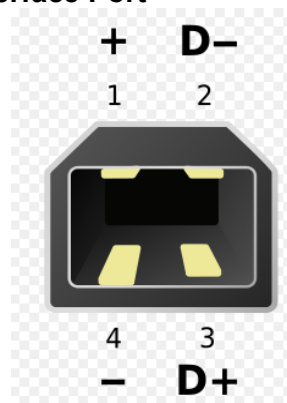

9. Packing Information

Item	Q'ty	Dimension (W x H x D)	Weight(Kg)	Remark
Closed Frame	1Pcs	1040.0mm x 630.0mm x 67.0mm	TBD	
Box Packing			TBD	
Pallet Size			TBD	
Pallet Packing			TBD	

10. Mechanical structure

Rev	AMEND	DATE	CHECK	APPR.
P1	Proto	2019.07.09	H.I.Woo	H.Y.Sohn
P2	Changed Model Name INC-4303UHZIPC-U ----> 150DLP4346	2019.07.09	H.I.Woo	H.Y.Sohn
P3	Added LED Lighting Control Port Slave 5V and GND	2019.07.17	H.I.Woo	H.Y.Sohn
P4				

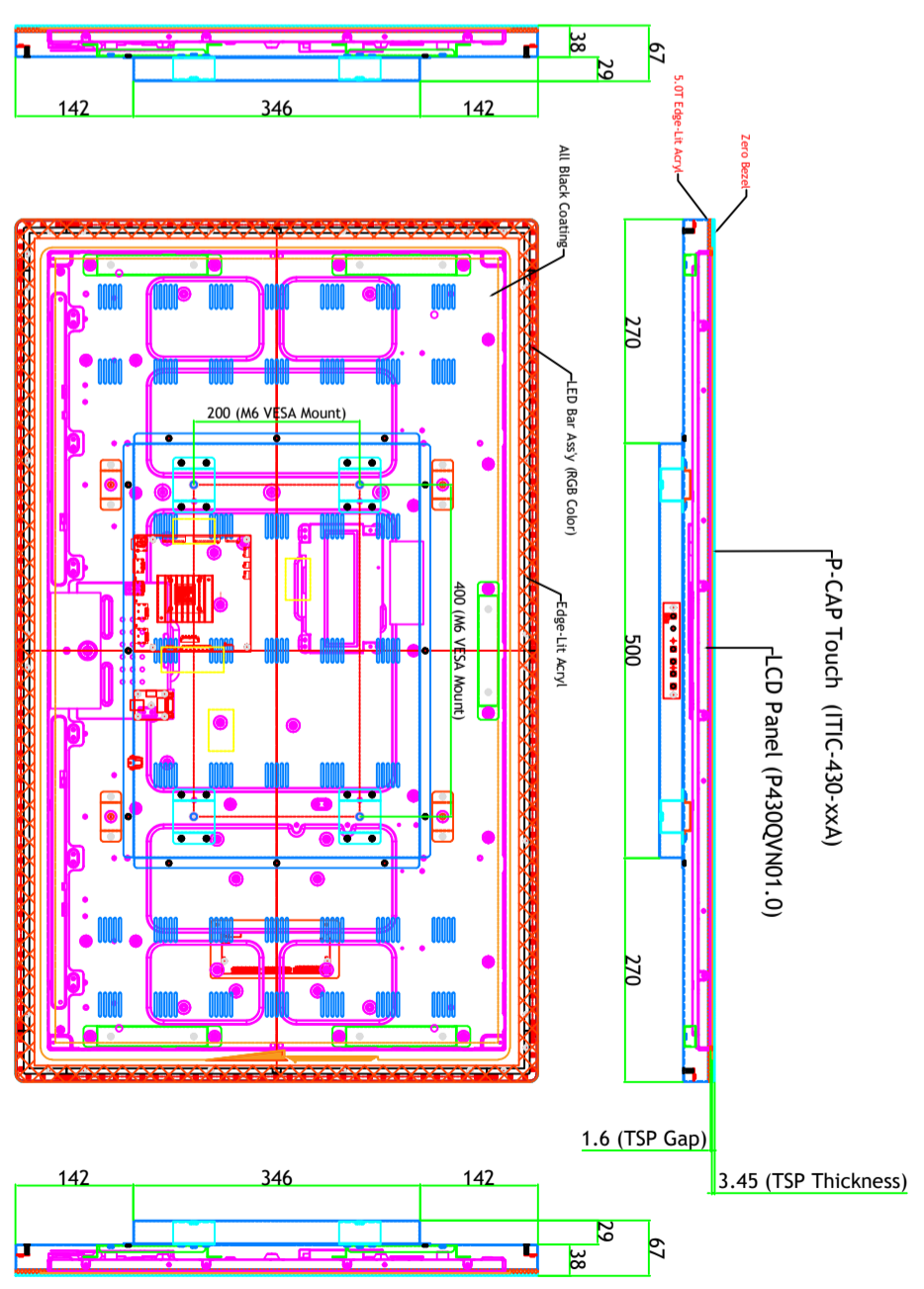
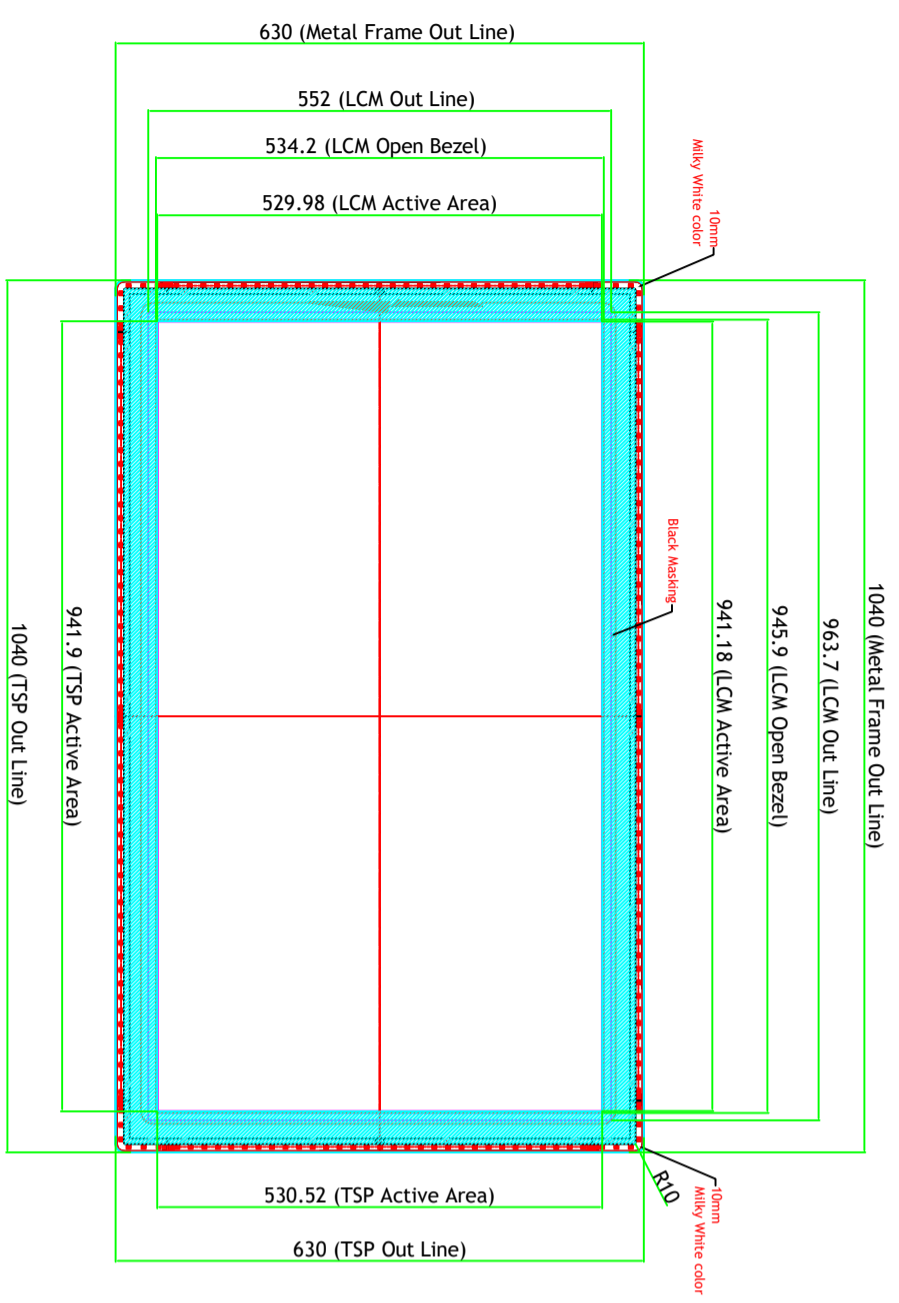

LED Lighting Control Port Pin Map (w/ IC)
 #1 : 5V, #2 : CTL, #3 : GND
 #4 : 5V, #5 : NC, #6 : GND

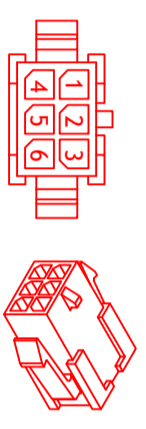

P3 Added
 Slave 5V and GND

		MODEL NO	150DLP4346	VIEW :		UNIT :	mm
		NAME	43" Closed Frame	Qty	1	REV.	P3
DRAWN	CHECKED	APPROVED	DWG. NO	SCALE	DATE		
H.I.Woo		H.Y.Sohn	4M4303020-02	1 / 1	2019.07.17		
MATERIAL / FINISH		EG1 T=1.2					

Main Frame EGI = 1.2T Black Coating
 Rear Cover EGI = 1.2T Black Coating

ASSEMBLY ITEM NUMBER	PART CHARACTERISTICS		MATERIAL
	NUMBER OF POSITION	PANEL MOUNT OPTION	
	43020-0200	02	
43020-0201	02	NO	
43020-0400	04	YES	
43020-0401	04	NO	
43020-0600	06	YES	
43020-0601	06	NO	
43020-0800	08	YES	
43020-0801	08	NO	
43020-1000	10	YES	
43020-1001	10	NO	
43020-1200	12	YES	
43020-1201	12	NO	
43020-1400	14	YES	
43020-1401	14	NO	
43020-1600	16	YES	
43020-1601	16	NO	
43020-1800	18	YES	
43020-1801	18	NO	
43020-2000	20	YES	
43020-2001	20	NO	
43020-2200	22	YES	
43020-2201	22	NO	
43020-2400	24	YES	
43020-2401	24	NO	

CKT. NO.	DIM. 'A'	DIM. 'B'	DIM. 'C'	DIM. 'D'
2	.152/(3.86)	N/A	.166/(4.21)	.311/(7.90)
4	.270/(6.85)	.118/(3.00)	.284/(7.21)	.429/(10.90)
6	.388/(9.85)	.236/(6.00)	.402/(10.21)	.547/(13.89)
8	.506/(12.85)	.354/(9.00)	.520/(13.21)	.665/(16.89)
10	.624/(15.85)	.472/(12.00)	.638/(16.21)	.783/(19.89)
12	.742/(18.85)	.591/(15.00)	.756/(19.21)	.901/(22.89)
14	.860/(21.85)	.709/(18.00)	.874/(22.20)	1.019/(25.88)
16	.978/(24.85)	.827/(21.00)	.992/(25.20)	1.137/(28.88)
18	1.096/(27.85)	.945/(24.00)	1.110/(28.20)	1.255/(31.88)
20	1.215/(30.85)	1.063/(27.00)	1.229/(31.22)	1.373/(34.87)
22	1.333/(33.85)	1.181/(30.00)	1.347/(34.22)	1.491/(37.87)
24	1.451/(36.85)	1.299/(33.00)	1.465/(37.22)	1.609/(40.87)

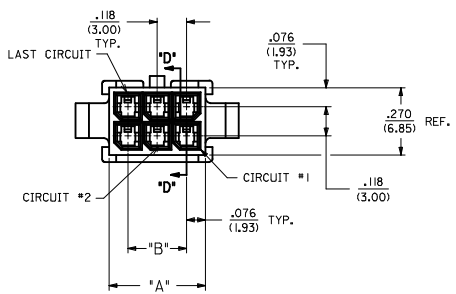

- NOTES:
- HOUSING MATERIAL:
 - 'A' - UNFILLED POLYESTER, RATED U.L. 94V-0, COLOR IS BLACK.
 - 'B' - UNFILLED NYLON, RATED U.L. 94V-0, HALOGEN-FREE, COLOR IS BLACK.
 - FINISH: N/A
 - PRODUCT SPECIFICATION: PS-43045
 - PACKAGING SPECIFICATION: PK-43020-001
 - THIS HOUSING MATES WITH MICRO-FIT RECEPTACLE #43025-****
 - THIS HOUSING TO BE USED WITH MOLEX MALE TERMINAL #43031-****
 - DESIGNED FOR .055(1.4) MINIMUM TO A .100(2.54) MAXIMUM THICK PANEL OR PRINTED CIRCUIT BOARD.
 - SEE SECTION "D"-D" FOR TERMINAL ORIENTATION IN HOUSING.
 - PANEL MOUNT FEATURES MUST LOCK ON SIDE OPPOSITE PUNCH SIDE FOR OPTIMUM RETENTION.
 - PART CONFORMS TO CLASS 'B' REQUIREMENTS OF COSMETIC SPECIFICATION PS-45499-002. SOME HOUSINGS MAY HAVE A SMALL GATE BLEMISH NEAR THE GATE LOCATION THAT DOES NOT AFFECT FUNCTIONALITY.

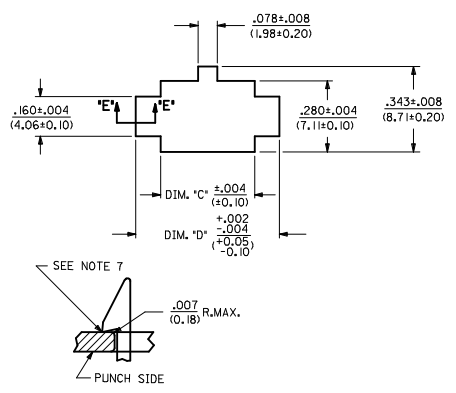

SECTION "E"-E"
NO SCALE

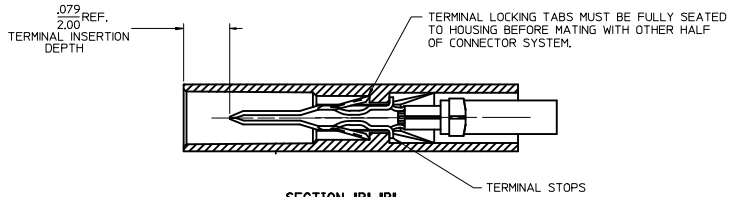
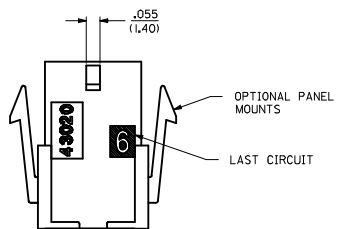
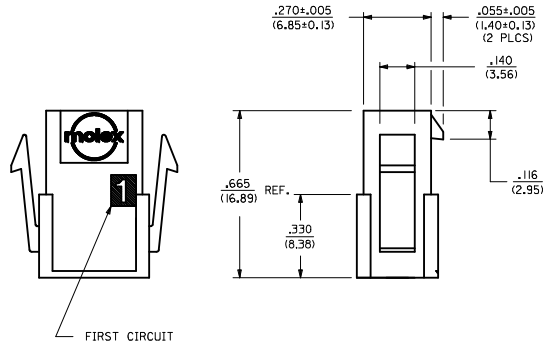

SECTION "B"-B"

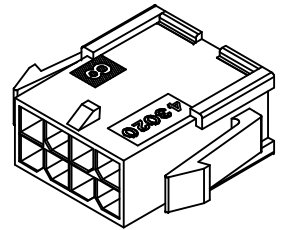

PLUG WITH OPTIONAL
PANEL MOUNTS
ISO VIEW
(8 CIRCUIT SHOWN)

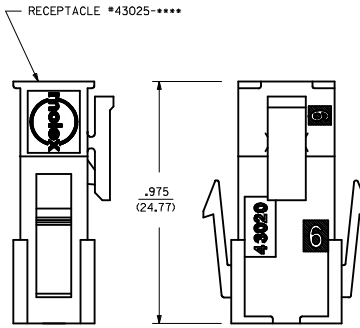

MATED MICRO-FIT CONNECTOR

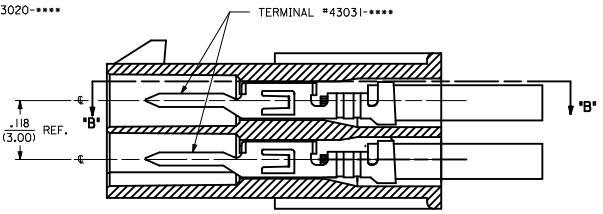

SECTION "D"-D"
WITH TERMINAL
SCALE B'

QUALITY SYMBOLS	GENERAL TOLERANCES (UNLESS SPECIFIED)	DIMENSION STYLE	SCALE	DESIGN UNITS	THIRD ANGLE PROJECTION
▽=0	4 PLACES ±.005	mm	DRAWN BY	DATE	MICRO-FIT(3,0) 2 THRU 24 CIRCUIT PLUG WITH OPTIONAL PANEL MOUNTS
▽=0	3 PLACES ±.010	INCH	AFG	1993/01/07	
▽=0	2 PLACES ±0.25	±.014	BAP	1993/01/07	
▽=0	1 PLACE ±0.35	±.014	APPROVED BY	DATE	
▽=0	0 PLACE ±.010	±.014	F.S.MITH	2016/10/07	
ANGULAR ±1/2°		MATERIAL NO.	DOCUMENT NO.		SHEET NO.
DRAFT WHERE APPLICABLE MUST REMAIN WITHIN DIMENSIONS		SEE CHART	SDA-43020-****		1 OF 1
THIS DRAWING CONTAINS INFORMATION THAT IS PROPRIETARY TO MOLEX INCORPORATED AND SHOULD NOT BE USED WITHOUT WRITTEN PERMISSION					

PART CHARACTERISTICS		
NUMBER OF POSITION	ASSEMBLY ITEM NUMBER	MATERIAL
02	43025-0200	'B'
04	43025-0400	
06	43025-0600	
08	43025-0800	
10	43025-1000	'A'
12	43025-1200	
14	43025-1400	'B'
16	43025-1600	'A'
18	43025-1800	'B'
20	43025-2000	
22	43025-2200	'A'
24	43025-2400	

CKT. NO.	DIM. "A" +0.14 -0.10 +0.35 -0.25	DIM. "B"
2	.152/(3.86)	N/A
4	.270/(6.85)	.118/(3.00)
6	.388/(9.85)	.236/(6.00)
8	.506/(12.85)	.354/(9.00)
10	.624/(15.85)	.472/(12.00)
12	.742/(18.85)	.591/(15.00)
14	.860/(21.85)	.709/(18.00)
16	.978/(24.85)	.827/(21.00)
18	1.096/(27.85)	.945/(24.00)
20	1.215/(30.85)	1.063/(27.00)
22	1.333/(33.85)	1.181/(30.00)
24	1.451/(36.85)	1.299/(33.00)

- NOTES:**
- HOUSING MATERIAL:
'A' - UNFILLED POLYESTER, RATED UL, 94V-0, COLOR IS BLACK.
'B' - UNFILLED NYLON, RATED UL, 94V-0, HALOGEN-FREE, COLOR IS BLACK.
 - FINISH: N/A
 - PRODUCT SPECIFICATION: PS-43045
 - PACKAGING SPECIFICATION: PK-43025-001
 - THIS RECEPTACLE MATES WITH 43020, 43045.
 - THIS RECEPTACLE TO BE USED WITH MOLEX FEMALE TERMINAL SERIES 43030 OR 46235. SEE SECTION 'A'-A' FOR TERMINAL ORIENTATION IN HOUSING.
 - FOR OVERMOLDING PARAMETERS SEE ENGINEERING SPECIFICATION #SDS-43025-1000.
 - TOP PULL TABS ARE NOT AVAILABLE ON 2 AND 4 CIRCUIT PARTS.
 - MOLEX RECOMMENDS THE USE OF MICRO-FIT TEST PLUG, SERIES NO. 44242-***** WHENEVER TESTING IS PERFORMED. TEST PLUGS MUST NOT BE USED FOR MAKE OR BREAK UNDER LOAD. MOLEX DOES NOT RECOMMEND USING STANDARD MATING COMPONENTS FOR HARNESS TESTING PURPOSES.
 - SOME HOUSINGS MAY HAVE A SMALL GATE BLEMISH NEAR THE GATE THAT DOES NOT AFFECT FUNCTIONALITY.
 - HOUSINGS HAVE EITHER AN IDENTIFIER RIB OR ENGRAVED '1' SYMBOL TO INDICATE CIRCUIT #1. IDENTIFIER TYPE IS TOOL DEPENDENT AND NOT SELECTABLE.
 - DIMENSION 'A' MEASURED AT DATUM \square -A-
 - THIS PART CONFORMS TO CLASS 'B' REQUIREMENTS OF COSMETIC SPECIFICATION PS-45499-002.

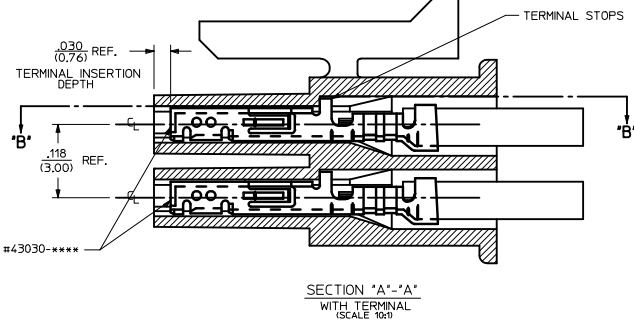
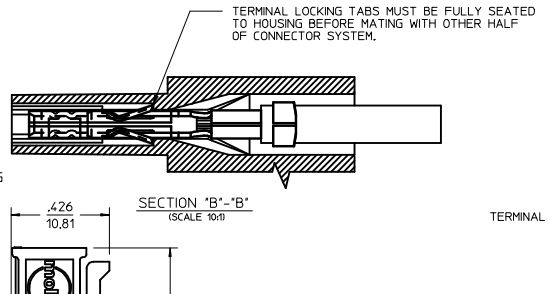
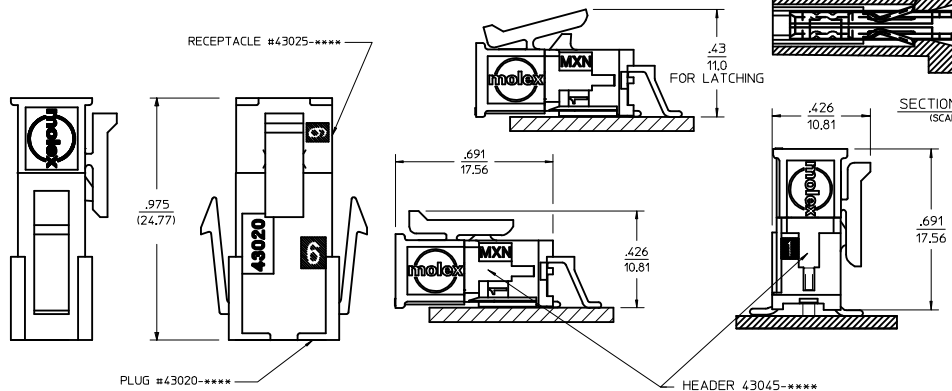
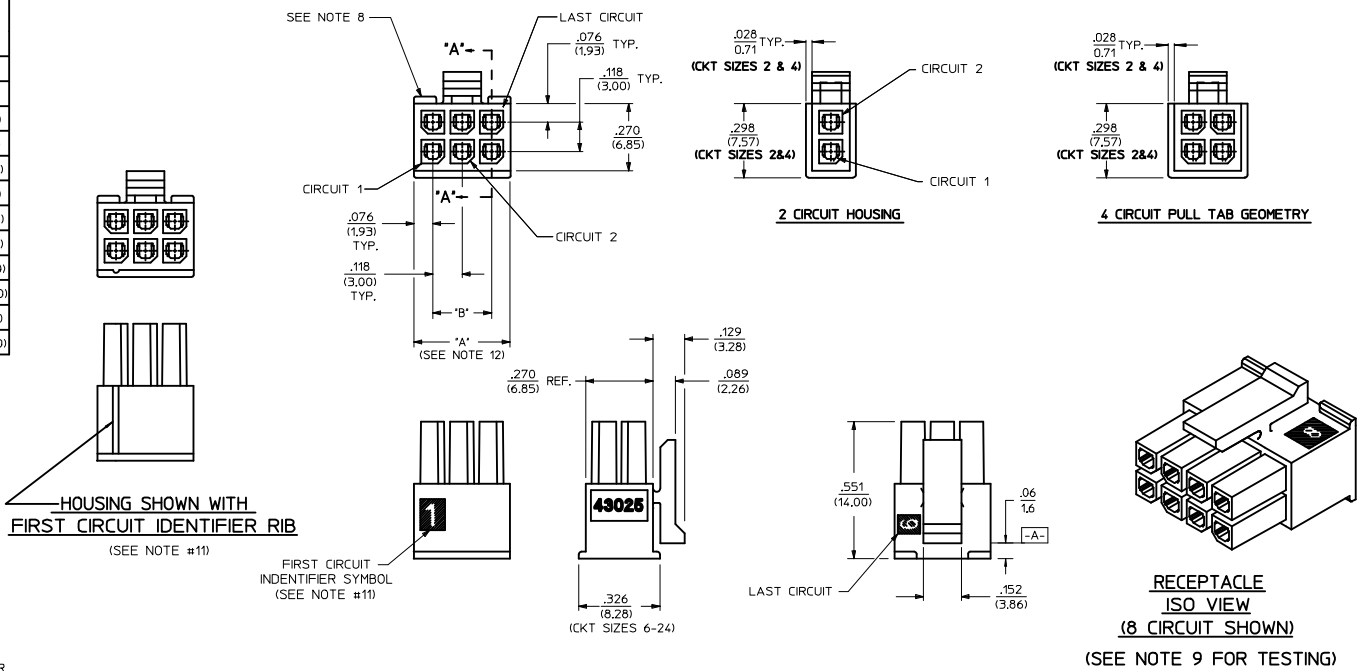

MATED MICRO-FIT CONNECTOR

ADD MATED VIEW IEC NO: UCP2016-4677 DRAWN BY: DRYNWAPELDOORN CHYKJDFOX APPROVED BY: FSMTHTH DATE: 2016/06/03 DATE: 2016/06/09	QUALITY SYMBOLS ▽=0 ▽=0 ▽=0	GENERAL TOLERANCES (UNLESS SPECIFIED): <table border="1"> <tr> <th></th> <th>mm</th> <th>INCH</th> </tr> <tr> <td>4 PLACES</td> <td>±.010</td> <td>±.004</td> </tr> <tr> <td>3 PLACES</td> <td>±.014</td> <td>±.005</td> </tr> <tr> <td>2 PLACES</td> <td>±.025</td> <td>±.010</td> </tr> <tr> <td>1 PLACE</td> <td>±.035</td> <td>±.014</td> </tr> <tr> <td>0 PLACE</td> <td>±.050</td> <td>±.020</td> </tr> </table>		mm	INCH	4 PLACES	±.010	±.004	3 PLACES	±.014	±.005	2 PLACES	±.025	±.010	1 PLACE	±.035	±.014	0 PLACE	±.050	±.020	DIMENSION STYLE: IN/MM SCALE: METRIC DESIGN UNITS: METRIC THIRD ANGLE PROJECTION
		mm	INCH																		
	4 PLACES	±.010	±.004																		
	3 PLACES	±.014	±.005																		
2 PLACES	±.025	±.010																			
1 PLACE	±.035	±.014																			
0 PLACE	±.050	±.020																			
MATERIAL NO: SEE CHART DOCUMENT NO: SDA-43025-**** SHEET NO: 1 OF 1	DRAWN BY: A.F.G. DATE: 1993/01/14 CHECKED BY: B.A.P. DATE: 1993/01/14 APPROVED BY: FSMTHTH DATE: 2016/05/02	TITLE: MICRO-FIT (3.0) 2 THRU 24 CIRCUIT RECEPTACLE molex	THIS DRAWING CONTAINS INFORMATION THAT IS PROPRIETARY TO MOLEX INCORPORATED AND SHOULD NOT BE USED WITHOUT WRITTEN PERMISSION																		
SIZE: D	DRAFT WHERE APPLICABLE MUST REMAIN WITHIN DIMENSIONS																				
ANGLAR ±1/2°																					