

MODEL : 150DLP4305

Zero Bezel with PCAP Touchscreen
 LED Illumination on Edge and Front, 4 Sides
 12V RGB LEDs, w/o IC

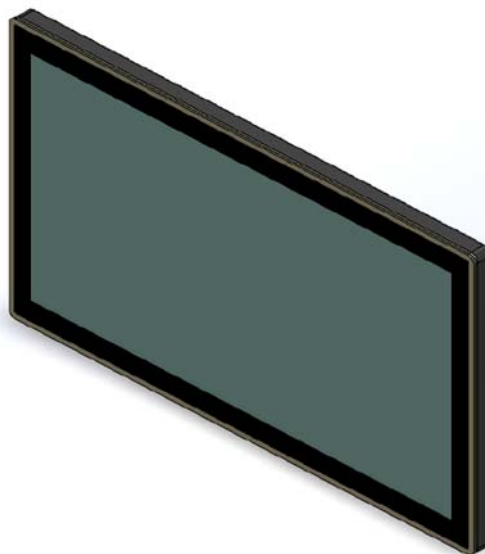

Revision	Date	History
V0.1	2019.05.28	Initial Release.
V1.0	2019.07.12	Changed Glass Active Area 941.2 x 529.4mm -> 941.9 x 530.52mm Changed Total Thickness 66.2mm -> 67.0mm

Draft _____

Date : _____

Checked: _____

Date : _____

Approved : _____

Date : _____

Contents

1. General Description

- 1.1 Overview
- 1.2 General Specifications
- 1.3 Environmental and Reliability Specification
- 1.4 Power Supply Rating
- 1.5 Input/Output Port

2. User Control & OSD

- 2.1 Key Control Board
- 2.2 OSD Control Function
- 2.3 OSD GUI Control Table

3. Connector Description

- 3.1 Summary
- 3.2 J6: 24VDC Power Input Connector
- 3.3 J8: Auto Dimming/RS232 Connector
- 3.4 J1: Backlight Inverter Connector
- 3.5 J15: OSD Board Connector
- 3.6 J2: 12VDC/5VDC External Output Connector
- 3.7 J4: 24VDC Input Jack
- 3.8 J11: DVI Input Connector
- 3.9 J23: VGA Input Connector
- 3.10 J14: LCD Interface Connector

4. Standard Display Modes

5. LED Backlight Driver Board Specification

6. Board Dimensions

7. LED Lighting Control Specification

8. Touchscreen Specification

9. Packing Information

10. Mechanical Structure

1. General Description

1.1 Overview

- ◆ SUZOHAPP Closed-frame LCD Monitor 150DLP4305 is a high performance TFT LCD monitor providing a high quality screen image.
- ◆ This monitor supports VGA and DVI-D input. Other input options are available.
- ◆ Wide input resolution range up to Full HD (1920 x 1080@60Hz).
- ◆ It is designed for industrial use with Auto power on, up scaling performance adequate for low-resolution applications and enhanced design margin for reliability.
- ◆ It is available in matching touch and non-touch designs.

1.2 General Specifications

LCD Panel	Size	42.51" (1079.87mm) Diagonal
	Active Display Area	941.2mm(H) x 529.416mm(V)
	Type No.	LG LD430EUE-FHB1
	Number of Pixels	1920 (H) x 1080 (V)
	Pixel Arrangement	RGB Vertical Stripe
	Pixel Pitch	0.4902mm x 0.4902mm
	Color Depth	16.7M True Colors
	Surface Treatments	Anti-Glare Haze 1%, Hard –coating (3H)
	Viewing Angle (CR>10)	R/L: 178 degree (89/89) U/D: 178 degree (89/89)
	Contrast Ratio	Typ. 1100 : 1
	Response Time(Typ.)	12ms
	Average Brightness	Typ. 450 cd/ m ²
	Frame Rate	Typ. 60Hz
	Backlight Unit	LED
Input Resolution	Prime	1920 x 1080 @ 60 Hz
	Standard	640x480 @60Hz/70Hz/75Hz 800x600 @56/60/72/75 Hz, 1024x768 @60/70/75 Hz, 1280x1024 @60/75 Hz, 1280x720@60Hz 1366x768@60Hz,1600x900@60Hz, 1680x1050@60Hz,1920x1080@60Hz

Input Signal Port	VGA	15pin D-Sub x 1Port
	DVI-D	24pin DVI-D x 1 Port
	Power Jack	Power Mini-Din 4P x 1 Port
Scanning Frequency	Horizontal	31 ~ 80Khz
	Vertical	55 ~75Hz
OSD Control		Menu, Select, Up, Down, Power
Plug & Play		VESA DDC 2B Ver1.3
Touchscreen	Touch Panel	P-CAP Touch : 43.0" Edge-Lit Touch / 10 Point (ITIC-430-xxA)
	Controller	TBD
	Controller Interface	USB 2.0 Type "B"
LED Frame Illumination (Without Controller)		Edge / Front Type, 4 sided
		LED Type : w/o IC Type (AT556M1SE3)
		Supports External 12V RGB-type LED Lighting Controller
		Interface Port : Molex 43020-0600
RoHS		RoHS2 Compliance
Mounting Options		400(H) x 200(V)mm M6 VESA Mounting Holes
Optional Accessories		Cables, Power Supply <for Addressable style, also say LED Lighting Controller>

Application Caution

- 1. Precautions for strong light exposure.**
Strong light exposure causes degradation of polarizer and color filter.

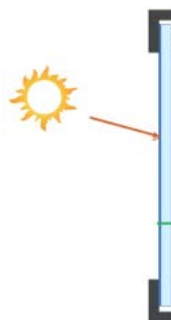

- 2. Using Conditions.**
- Temperature inside the cabinet should be controlled 'at room temp' (0 ~ 40°C) by cooler and fan.

1.3 Environmental and Reliability Specification

- This specification depends on the LCD panel characteristics. Please refer to the manufacturer’s panel specification for details.

Item	Symbol	Min	Max	Unit
Operating Temperature	TOP	0	+50	°C
Operating Humidity	HOP	10	90	%
Storage Temperature	TST	-20	+60	°C
Storage Humidity	HST	10	90	%

1.4 Power Supply Rating

Optional PSU Input Voltage	AC 100 ~ 240VAC,50/60Hz			
Optional PSU Output Voltage	DC 24V/5.0A			
Monitor DC Input Voltage	24VDC			
Power Consumption	Typ. 72W (24VDC / 3.0A)			
LED String Lighting Specification (w/o IC RGB 12V Type)	Min	Typ.	Max	Unit
Input Voltage	11.4	12.0	12.6	[V]
Input Current		TBD		[A]
Power Consumption		TBD		[W]

- Conditions of Measurement
 - 1) LED pattern: LED Bar full white light, non-scrolling.
 - 2) Current consumption tolerance: + 10%.

1.5 Input/Output Port

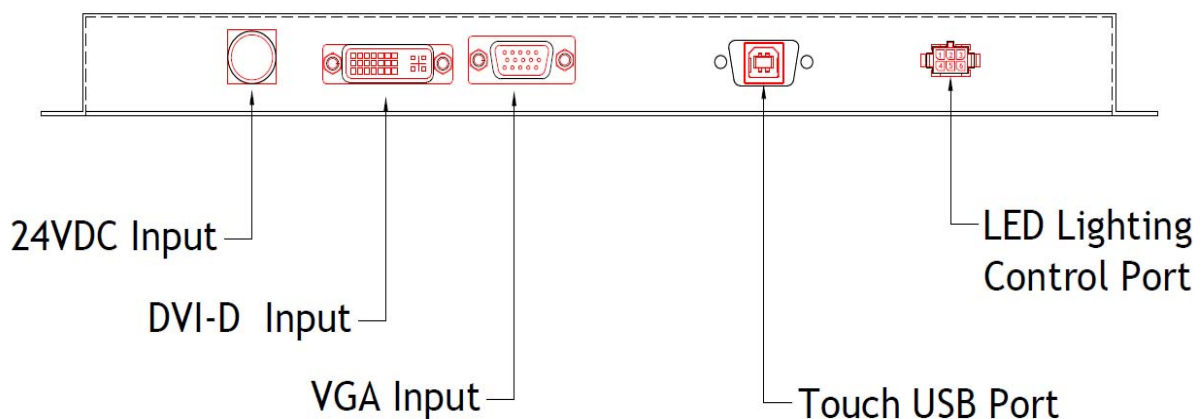

2. User Control & OSD

2.1 Key Control Board

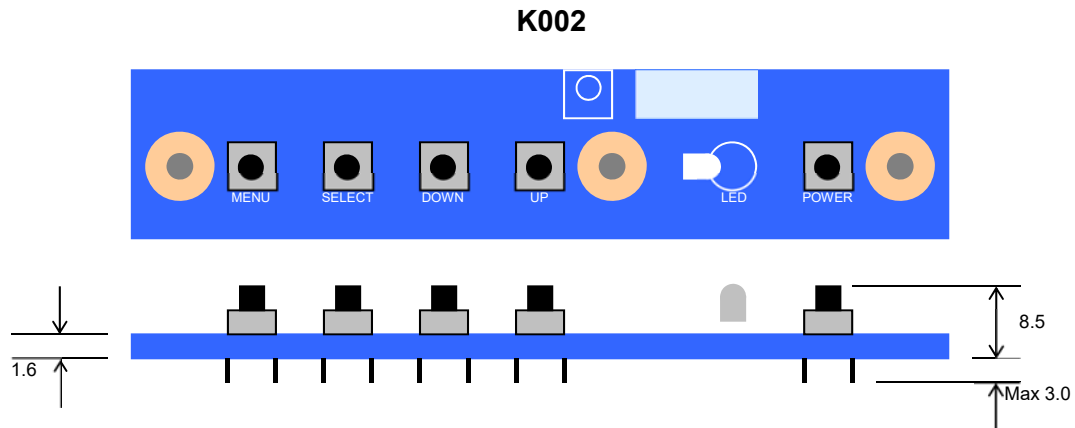

Button	Function	Status	HOT Key
LED	Indicates operation status	Green : Normal State Red : Off Mode Green Blinking : DPMS Mode	
POWER	Power on/off		
MENU	Enable MENU Window Disable MENU Window Exit from Sub function		
SELECT	Select function		No OSD Window, Input Source Change
DOWN	Move to Down or Left		No OSD Window, Auto Color
UP	Move to Up or Right		No OSD Window, Auto Configuration

2.2 OSD Control Function

The chosen OSD settings will be stored in memory. The OSD menu can be cleared from the screen by pressing the **MENU** button otherwise it will be automatically cleared after a few second of non-use.

2.2.1 OSD Main Menu

1) PICTURE

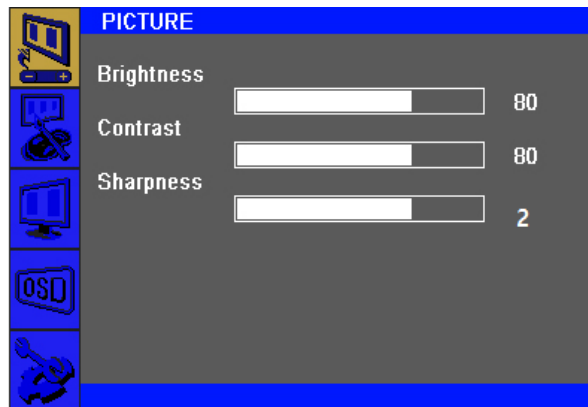

Brightness (0 ~ 100)	Increases/decreases monitor Brightness. Default: 100
Contrast (0 ~ 100)	Increases/decreases monitor Contrast. Default: 100
Sharpness (0 ~ 4)	Adjusts Sharpness of the displayed images. Default : 2

2) COLOR

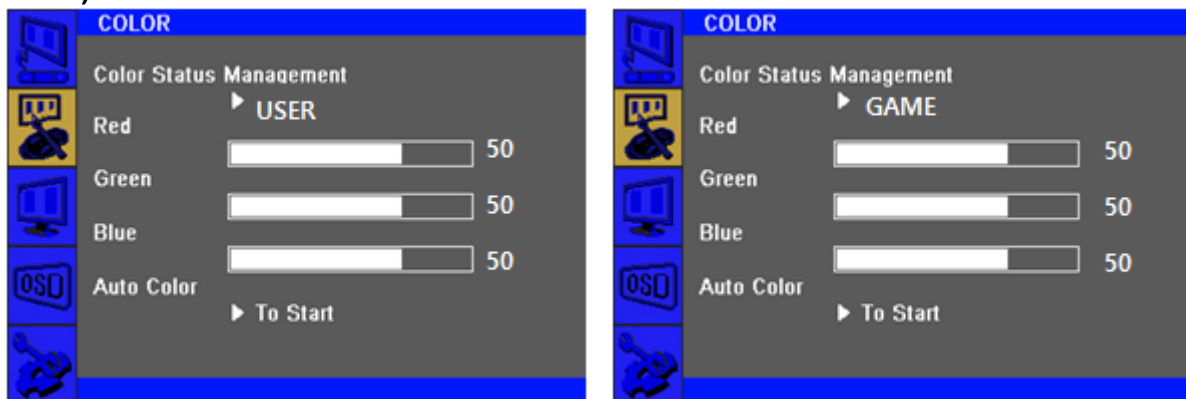

Color Status Management	Selects the display's color temperature. The available color settings "Normal", "Warm", "Cool", "User", "Game" mode. Default : User
Red (0 ~ 100)	Increases/decreases Red Color Temperature. Default : 50
Green (0 ~ 100)	Increases/decreases Green Color Temperature. Default : 50
Blue (0 ~ 100)	Increases/decreases Blue Color Temperature. Default : 50
Auto Color	Automatically adjusts the system color to the input VGA.

3) SCREEN (VGA input only)

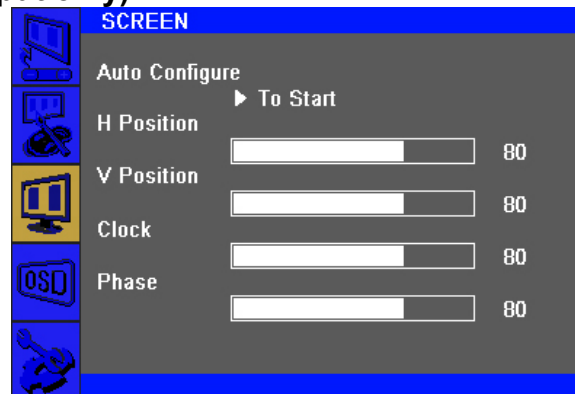

Auto Configure	Automatically adjusts the system clock to the input VGA.
H Position (0 ~ 100)	Moves the image horizontally on the display in single-pixel increments. Default : 50
V Position (0 ~ 100)	Moves the image vertically on the display in single-pixel increments. Default : 50
Clock (0 ~ 100)	Allows fine adjustments of the panel's pixel dot clock. Default : 50
Phase (0 ~ 100)	Allows fine adjustments of the panel's pixel dot clock phase. Default : 50
WXGA Mode	Selects WXGA Mode Off, 1024 x 768, 1280 x 768, 1360 x 768, 1366 x 768 Default : Off

4) OSD

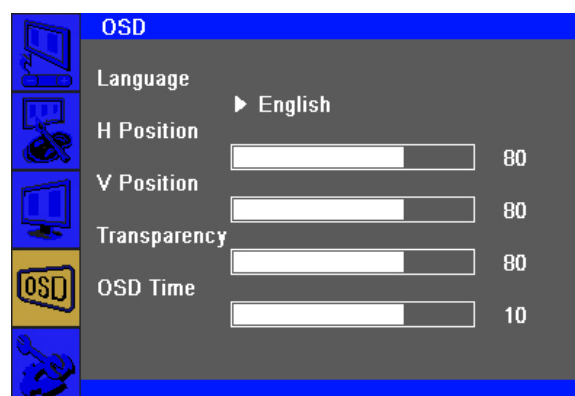

Language	Selects the OSD's display language. The available languages are English, Deutsch, Français, Italiano, Español, Korean. Default : English
H Position (0 ~ 100)	Adjusts the horizontal location of the OSD menus on the display. Default : 50

V Position (0 ~ 100)	Adjusts the vertical location of the OSD menus on the display. Default : 50
Transparency (0 ~ 100)	Adjusts the transparency of the OSD menus on the display. Default : 33
OSD Time (0 ~ 60)	Adjusts how long the touch monitor will wait without OSD button activity before closing the OSD. The adjustable range is between 0 and 60 seconds. Default : 10

5) SETUP

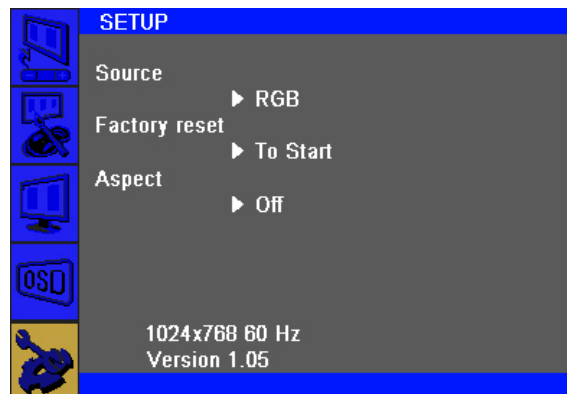

Source	Selects Input Source VGA (RGB), DVI.
Factory reset	Restores all factory default settings for OSD-adjustable parameters and for Preset Video Mode timings.
Aspect	Switches the scaling method between Full Scaling and Maintain Aspect Ratio. Default : Off

3. Connector Description

3.1 Summary

Reference	Item	Description	Type	Manufacture
J6	Connector	External 24VDC Power Input Connector	20010WS-04	YEONHO
J8	Connector		SMW200-04	YEONHO
J1	Connector	Backlight Inverter Connector	SMAW200-8	YEONHO
J2	Connector	12VDC/5VDC External Power Output Connector	SMAW200-6	YEONHO
J4	Jack	24VDC Input Power Jack	Mini-Din 4P	-
J11	Connector	DVI-D Input(TMDS) Connector	DVI-D24P	-
J23	Connector	VGA Input Connector	15P D-SUB	-
J14	Connector	LCD Interface Connector(2Ch LVDS)	YDW200-30	YEONHO
J15	Connector	OSD Board Connector	SMAW200-07	YEONHO

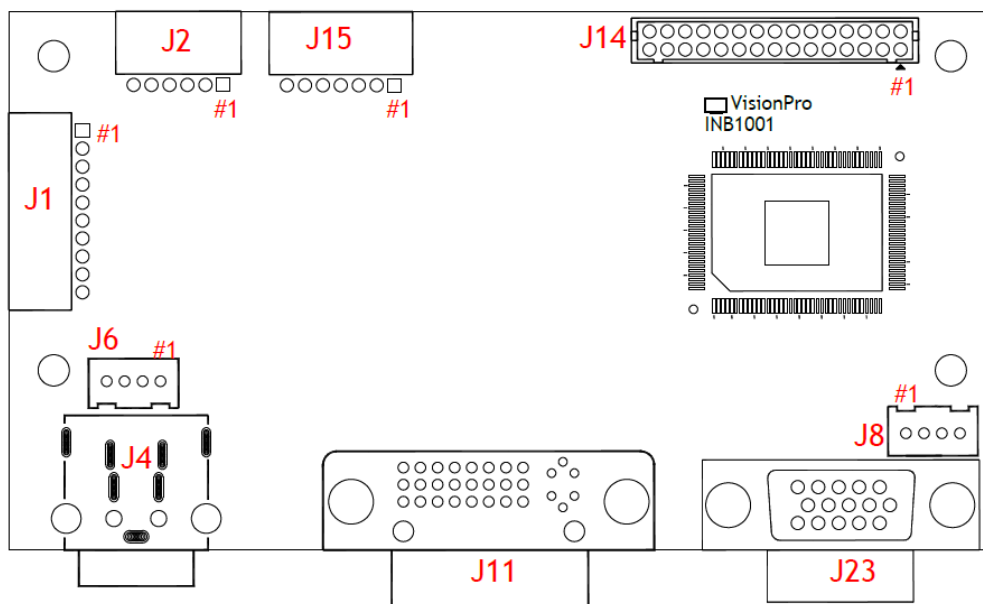

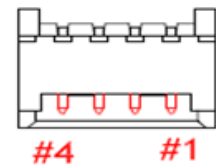

3.2 J6: 24VDC Power Input Connector

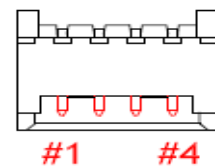
Pin No.	Symbol	Description
1	VCC	24VDC
2	VCC	24VDC
3	GND	Ground
4	GND	Ground

3.3 J8: Auto-Dimming / RS232 Connector

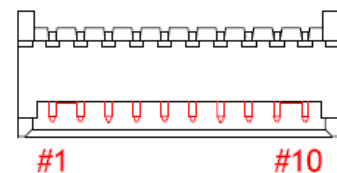
Pin No.	Symbol	Description
1	RS232 RX	RS232 RX
2	RS232 TX	RS232 TX
3	Auto- Backlight	Auto-Dimming
4	GND	Ground

3.4 J1: Backlight Inverter Connector

Pin No.	Symbol	Description
1	DIM-ADJ	DIM-adjustment analog dimming control signal. * make sure inverter specification
2	ON/OFF	Inverter digital ON(3.3V)/OFF(0V) signal.
3,4,5,6	GND	Ground
7,8,9,10	VCC	24VDC

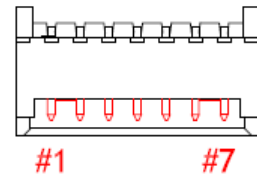
3.5 J15: OSD Board Connector

Pin No.	Symbol	Description
1	VCC	+5V Power for IR sensor
2	IRQ	Infrared rays signal line.
3	LED1	Green LED
4	LED2	Red LED
5	GND	Ground
6	ADC-IN0	Menu, Up
7	ADC-IN1	Power, Down, Up

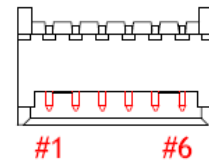
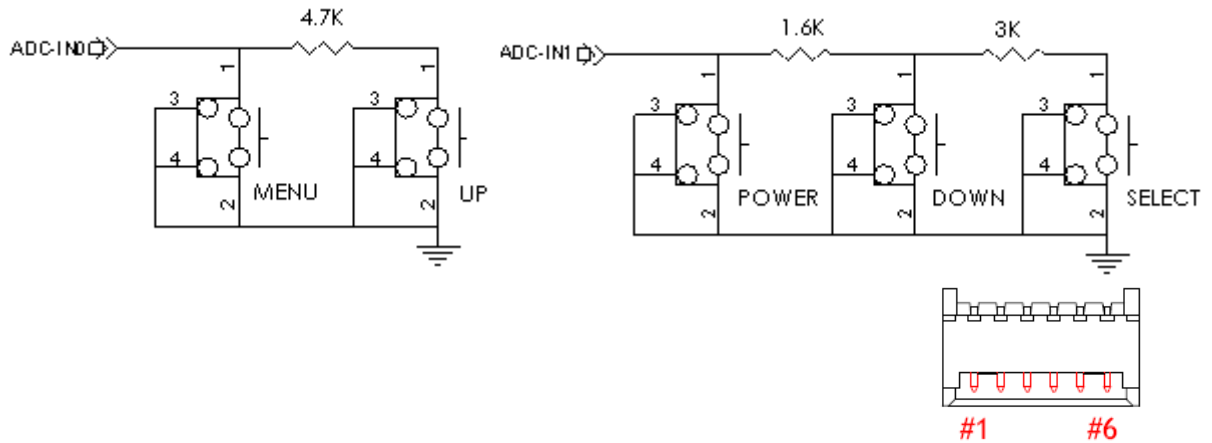
3.6 J2: 12VDC / 5VDC External Power Output Connector

Pin No.	Symbol	Description
1	12V	12VDC Output
2	12V	12VDC Output
3	5V	5VDC Output
4	5V	5VDC Output
5	GND	Ground
6	GND	Ground

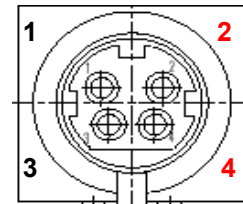
3.7 J4: 24VDC Power Input Jack

Pin No.	Symbol	Description
1,3	GND	Ground
2,4	VCC	24VDC

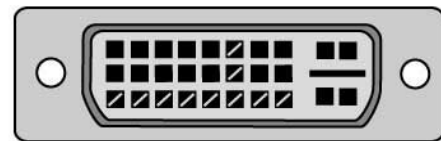
3.8 J11: DVI-D Input (TMDS) Connector

Pin No.	Symbol	Description
1	TMDS DATA2-	TMDS DATA2 Differential Negative Signal
2	TMDS DATA2+	TMDS DATA2 Differential Positive Signal
3	TMDS DATA2 Shield	Shield for TMDS Channel #2
4	NC	No Connection
5	NC	No Connection
6	DDC Clock	The Data Line for the DDC Interface
7	DDC Data	The Clock Line for the DDC Interface
8	NC	No Connection
9	TMDS DATA1-	TMDS DATA1 Differential Negative Signal
10	TMDS DATA1+	TMDS DATA1 Differential Positive Signal
11	TMDS DATA1 Shield	Shield for TMDS Channel #1
12	NC	No Connection
13	NC	No Connection
14	+5V Power	+5 Volt signal for EDID (Un-powered Monitor)
15	GND(for +5V)	Ground for +5 Volt Power pin, Sync return
16	HPD	Identify the Presence of a Monitor
17	TMDS DATA0-	TMDS DATA0 Differential Negative Signal
18	TMDS DATA0+	TMDS DATA0 Differential Positive Signal
19	TMDS DATA0 Shield	Shield for TMDS Channel #0
20	NC	No Connection
21	NC	No Connection
22	TMDS CLOCK Shield	Shield for TMDS Clock Differential Pair
23	TMDS CLOCK+	TMDS DATA0 Differential Positive Signal
24	TMDS CLOCK-	TMDS DATA0 Differential Negative Signal

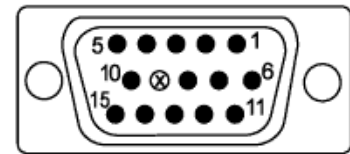
3.10 J23: VGA Input Connector

Pin No.	Symbol	Description
1	Red1	Red Analog Input
2	Green1	Green Analog Input
3	Blue1	Blue Analog Input
4	GND	Ground
5	GND	Ground
6	GND	Ground
7	GND	Ground
8	GND	Ground
9	NC	No Connection
10	GND	Ground
11	GND	Ground
12	DSDA	DDC-SDA
13	HSYNC	Horizontal Sync
14	VSYNC	Vertical Sync
15	DSCL	Serial Clock Input

3.11 J14: LCD Interface Connector (8bit 2Ch LVDS)

Pin No.	Symbol	Description
1	MOD_PWR	Panel Power (12V, 5V or 3.3V)
2	MOD_PWR	Panel Power (12V, 5V or 3.3V)
3	Option	High/Low for LCD Option
4	MOD_PWR	Panel Power (12V, 5V or 3.3V)
5	NC	No Connection
6	NC	No Connection
7	GND	Ground
8	GND	Ground
9	Y3N-EVEN	Negative(-) LVDS differential second 3 data
10	Y3P-EVEN	Positive(+) LVDS differential second 3 data
11	YCN-EVEN	Negative(-) LVDS differential second Clock
12	YCP-EVEN	Positive(+) LVDS differential second Clock
13	Y2N-EVEN	Negative(-) LVDS differential second 2 data
14	Y2P-EVEN	Positive(+) LVDS differential second 2 data
15	Y1N-EVEN	Negative(-) LVDS differential second 1 data
16	Y1P-EVEN	Positive(+) LVDS differential second 1 data
17	Y0N-EVEN	Negative(-) LVDS differential second 0 data
18	Y0P-EVEN	Positive(+) LVDS differential second 0 data
19	GND	Ground
20	GND	Ground
21	Y3N- ODD	Negative(-) LVDS differential first 3 data
22	Y3P-ODD	Positive(+) LVDS differential first 3 data
23	YCN- ODD	Negative(-) LVDS differential first Clock
24	YCP- ODD	Positive(+) LVDS differential first Clock
25	Y2N- ODD	Negative(-) LVDS differential first 2 data
26	Y2P- ODD	Positive(+) LVDS differential first 2 data
27	Y1N- ODD	Negative(-) LVDS differential first 1 data
28	Y1P- ODD	Positive(+) LVDS differential first 1 data
29	Y0N- ODD	Negative(-) LVDS differential first 0 data
30	Y0P- ODD	Positive(+) LVDS differential first 0 data

4. Standard Display Modes

ITEM	STD	Resolution	Pixel Frequency (MHz)	Vertical Frequency (Hz)	Horizontal Frequency (KHz)	Sync. Polarity (H/V)	Remark
1		640*400	25.175	59.940	31.469		
2		640*480	25.175	59.940	31.469		VGA
3	VESA	640*480	25.200	60.000	31.500		VGA
4	VESA	640*480	31.500	72.809	37.861		VGA
5	VESA	640*480	31.500	75.000	37.500		VGA
6	IBM	720*400	28.322	70.087	31.469		
7	VESA	800*600	36.000	56.250	35.156		SVGA
8	VESA	800*600	40.000	60.317	37.879		SVGA
9	VESA	800*600	50.000	72.188	48.077		SVGA
10	VESA	800*600	49.500	75.000	46.875		SVGA
11	VESA	1024*768	65.000	60.000	48.363		XGA
12	VESA	1024*768	75.000	70.069	56.476		XGA
13	VESA	1024*768	78.750	75.029	60.023		XGA
14		1152*864	94.500	70.012	63.851		
15	VESA	1152*864	108.000	75.000	67.500		
16		1280*720	74.501	59.856	44.772		WXGA
17		1280*768	79.499	59.870	47.776		WXGA
18	VESA	1280*960	108.000	60.000	60.000		WXGA
19		1360*768	72.000	59.960	47.368		WXGA
20	VESA	1280*1024	108.000	60.020	63.981		SXGA
21	VESA	1280*1024	135.000	75.025	79.976		
22		1680*1050	146.250	59.954	65.290		WSXGA+
23		1600* 900	118.998	55.920	60.000		
24		1920*1080	138.500	59.934	66.587		
25		1920*1080	148.500	60.000	67.500		1080P
26		1920*1080	148.352	59.940	67.433		1080P

5. LED Backlight Driver Board Specification

5.1 Electrical Specification

Item	Symbol	Spec	Unit	Remarks
Input Voltage 1	Vin	23.0 ~25.0	V	
Input Voltage 2	ON / OFF	0 ~ 5.0	V	
Operating Temperature	TOP	0 ~ 50	°C	
Storage Temperature	Tstg	-20 ~ 60	°C	
Relative Humidity	RH	80	%	

5.2 Control Signal

Item	Symbol	Status	Action	Remarks
CN1 #12	ON/OFF	HIGH	LED-ON	2.4V ~ 5.25V
		LOW	LED-OFF	0.8V Max

5.3 Output Characteristics

Item	Sym.	Condition	Min.	Typ.	Max.	Unit
Input Voltage	Vin	-	21.6	-	26.4	Vdc
Input Current	Iin	Vin=24V, Dim=0V	-	-	2.3	A
Output Current	Iout (max)	Vin=24V, Dim=0V	140.0	155.0	170.0	mAmean
	Iout (min)	Vin=24V, Dim=5V	30.0	35.0	40.0	
Backlight ON/OFF Control	ON	-	2.4	-	5.25	Vdc
	OFF	-	-0.3	-	0.8	

* Output Voltage is greater than Input Voltage for at least 3V or more.

5.4 Interface

5.4.1 CN1 Connector: 20010WR-14 (YeonHo) or EQ

Pin	Symbol	Remarks
1,2,3,4,5	Vin	Input Voltage 24VDC
6,7,8,9,10	GND	GND
12	On/Off	Backlight On/Off (5V:On, 0V : Off)
14	PDIM	External PWM

5.4.2 CN2 Connector: 20037WR-07 (YeonHo) or EQ

Pin	Symbol	Remarks
1	FB_L	Feedback Left (Return Left)
3	VLED_L	System Output Left
5	FB_R	Feedback Right (Return Right)
7	VLED_R	System Output Right
2,4,6	NC	No Connection

6. Board Dimensions

6.1 AD Board (INB1001) Dimension (110mm x 60mm x 14.5mm)

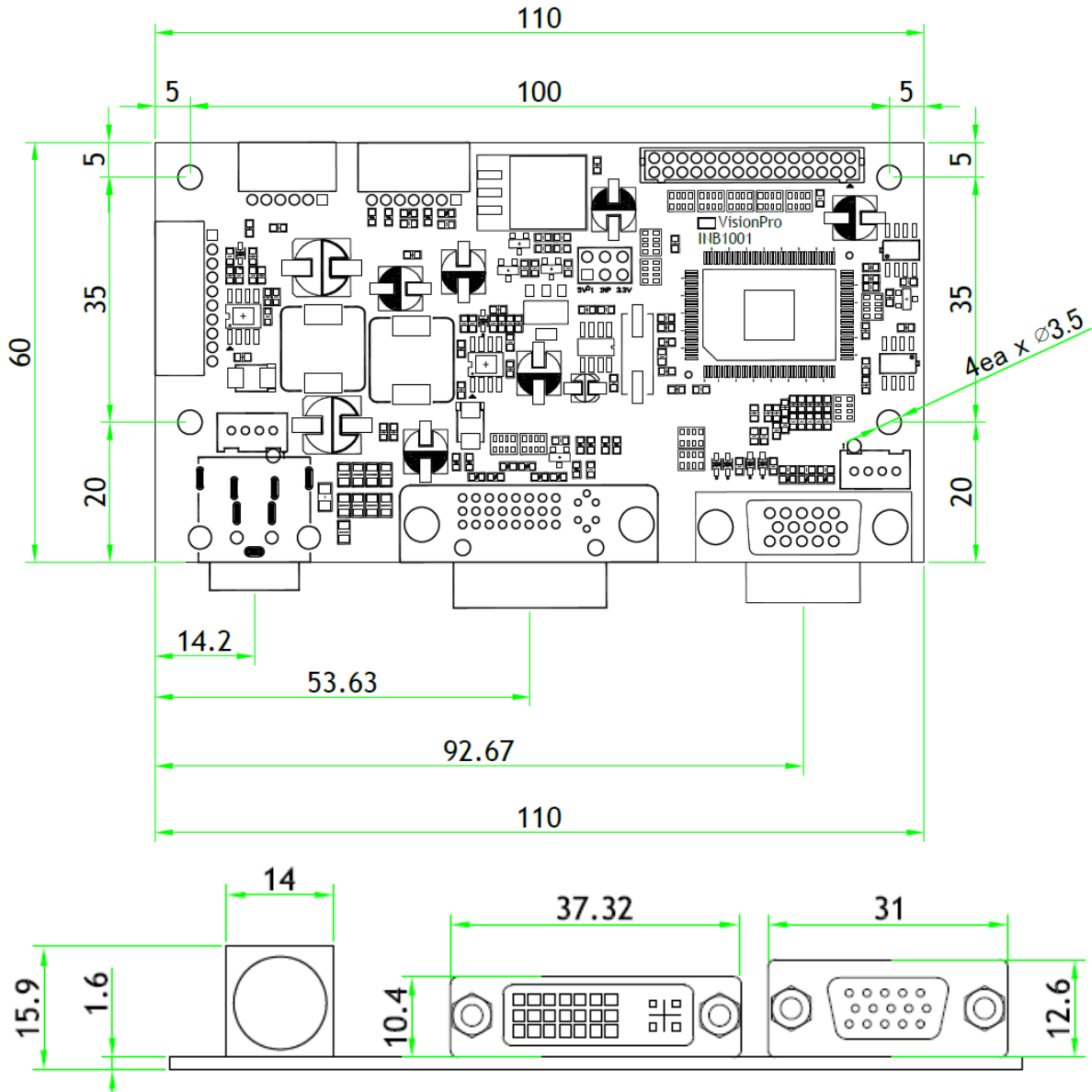

6.2 OSD Board (K002) Dimension (115mm x 20mm x 8.7mm)

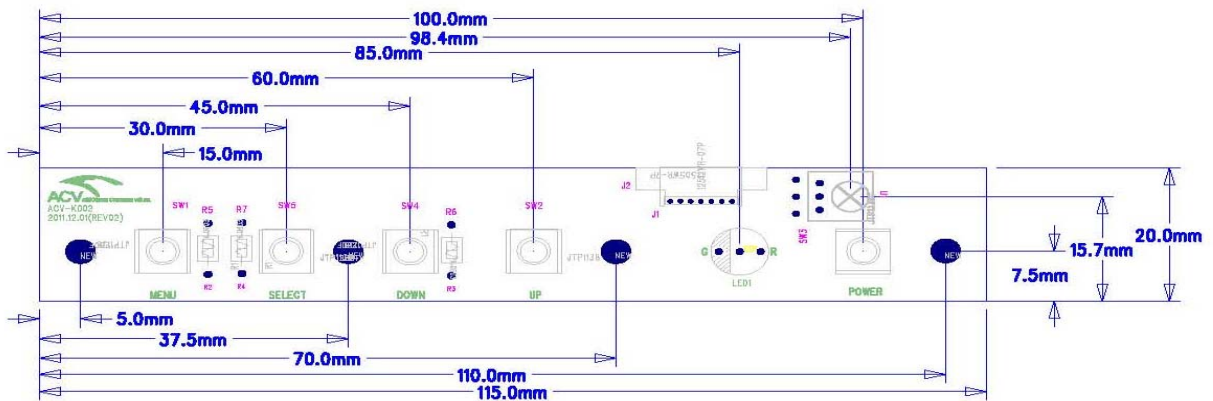

6.3 LED Backlight Driver Board (GH738A(A2) Dimension (120.0mm x 70.0mm x 21.6mm)

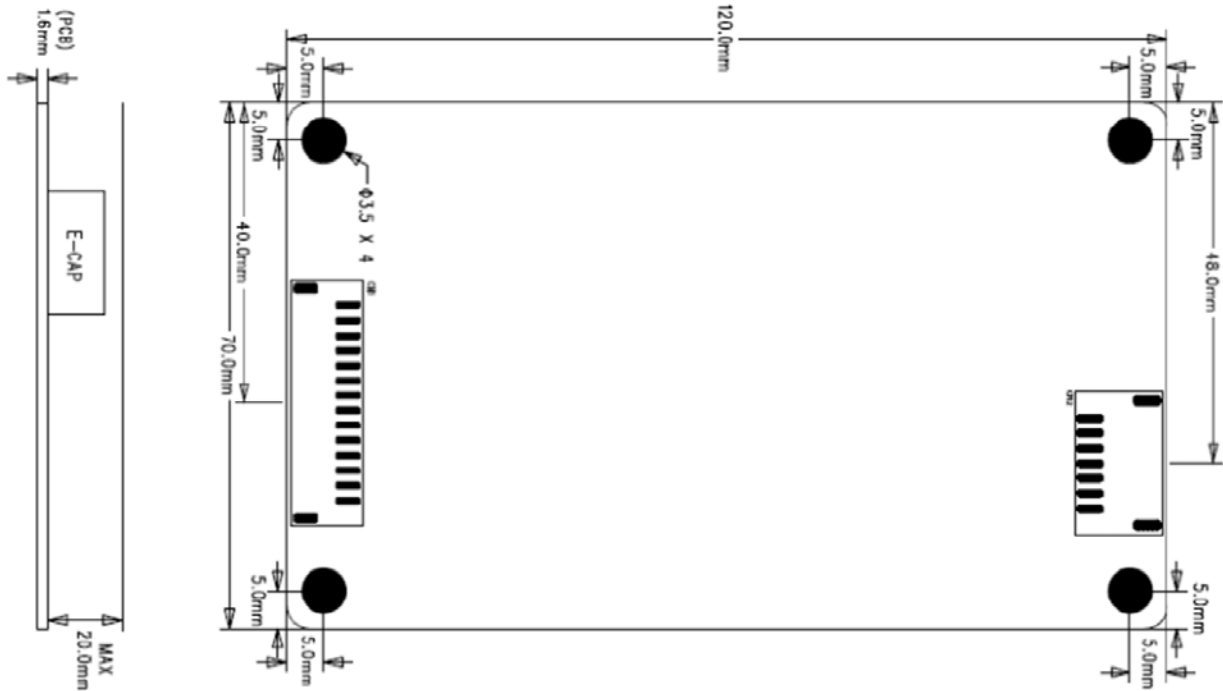

7. LED Lighting Control Interface Specification

7.1 Connector Spec

- Connector: Molex 43020-0600

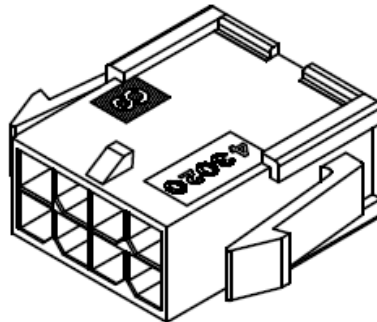

- Matching Housing: Molex 43025-0600

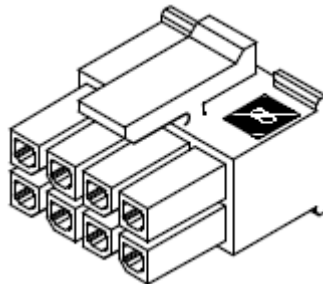

7.2 External LED Connector Pin Map

7.2.1 Without IC LED Bar Board

LED Lighting Control Port Pin Map
 #1 : Red , #2 : Green , #3 : Blue
 #4 : VCC 12V , #5 : GND , #6 NC



Pin No	Symbol	Remark
1	RED	Red LED Control Line
2	GRN	Green LED Control Line
3	BLU	Blue LED Control Line
4	VCC	VCC 12V Input
5	GND	GND
6	NC	Not Connection

7.3 Without IC LED Specification

7.3.1 LED Pin Configuration

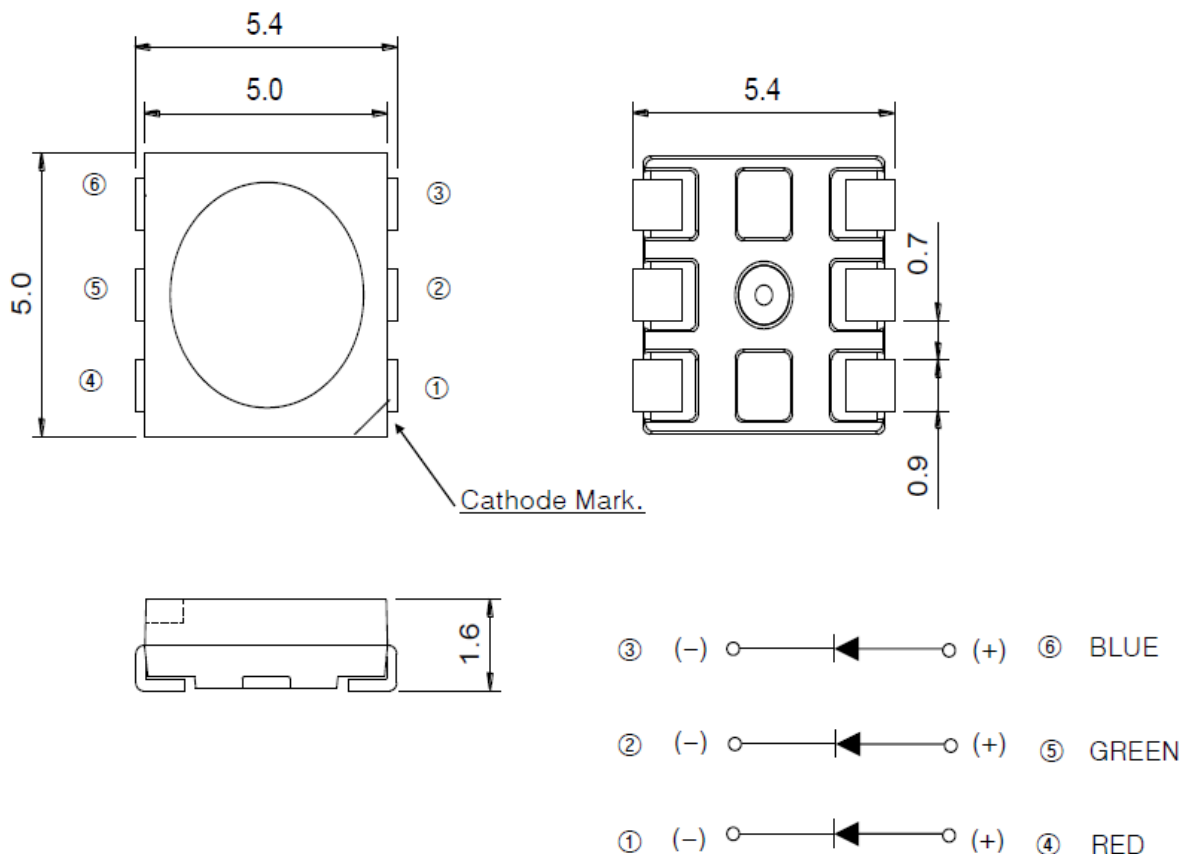

8. P-CAP Touchscreen Specification

8.1 Touchscreen Dimension (1040.0mm x 630.0mm x 3.4mm)

8.2. USB Connector (USB 2.0, Type “B”)

Number	Signal Name
1	+5V
2	D-
3	D+
4	GND

8.3 USB Interface Port

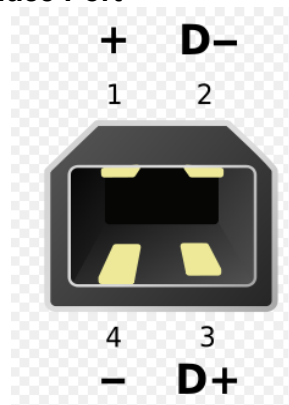

9. Packing Information

Item	Q'ty	Dimension (W x H x D)	Weight(Kg)	Remark
Closed Frame	1Pcs	1040.0mm x 630.0mm x 67.0mm	TBD	
Box Packing			TBD	
Pallet Size			TBD	
Pallet Packing			TBD	

10. Mechanical structure

Rev	AMEND	DATE	CHECK	APPR.
P1	Proto	2019.05.28	H.I.Woo	H.Y.Sohn
P2	Changed Touch Active Area 941.2 x 529.4mm ----> 941.9 x 530.52mm Changed Total Thickness 66.2mm ----> 67.0mm	2019.07.12	H.I.Woo	H.Y.Sohn
P4				

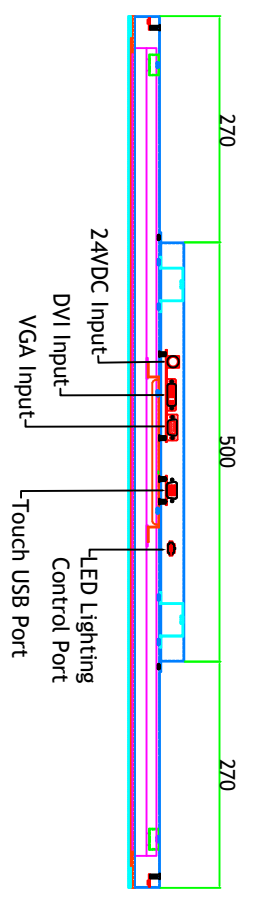
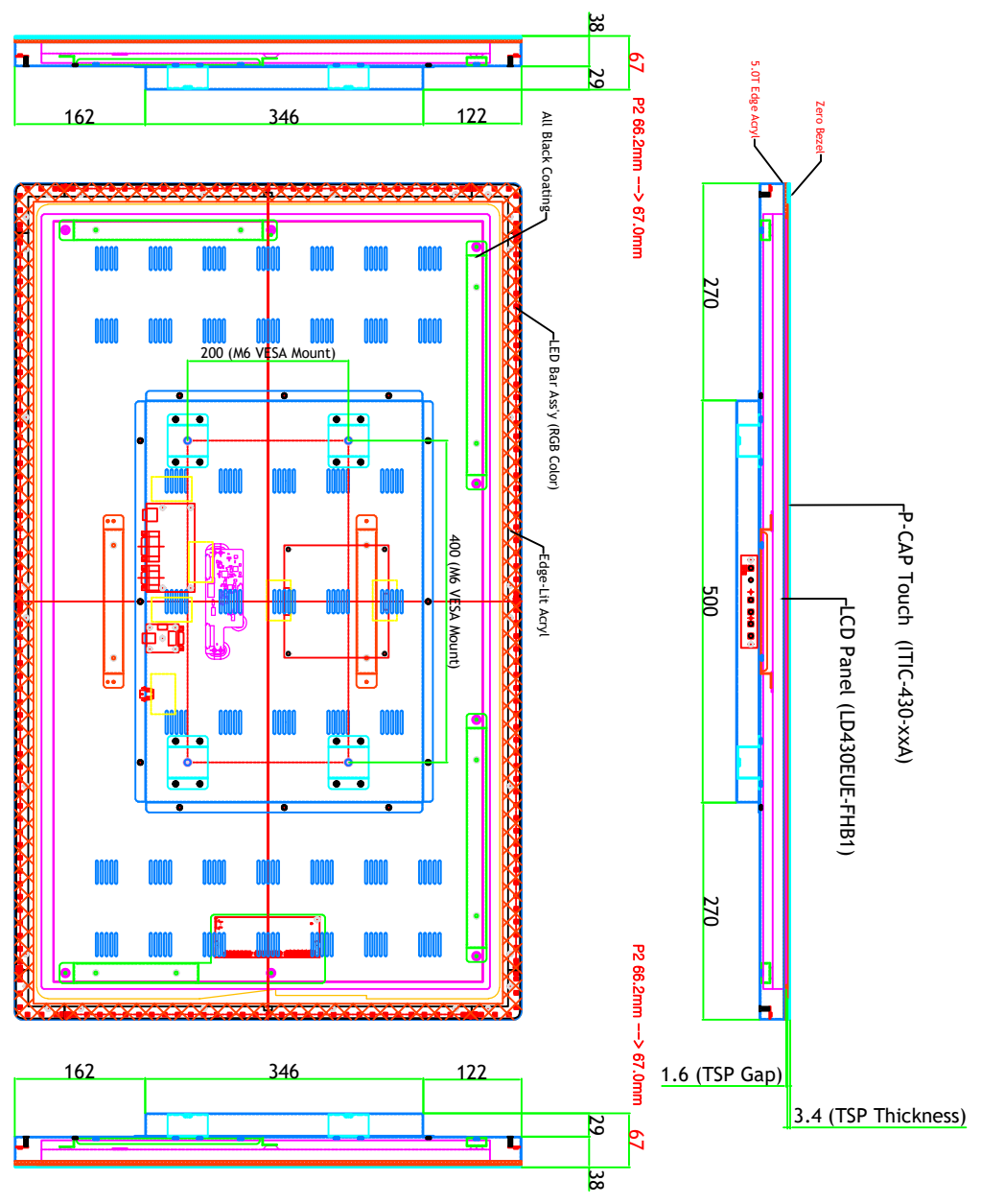
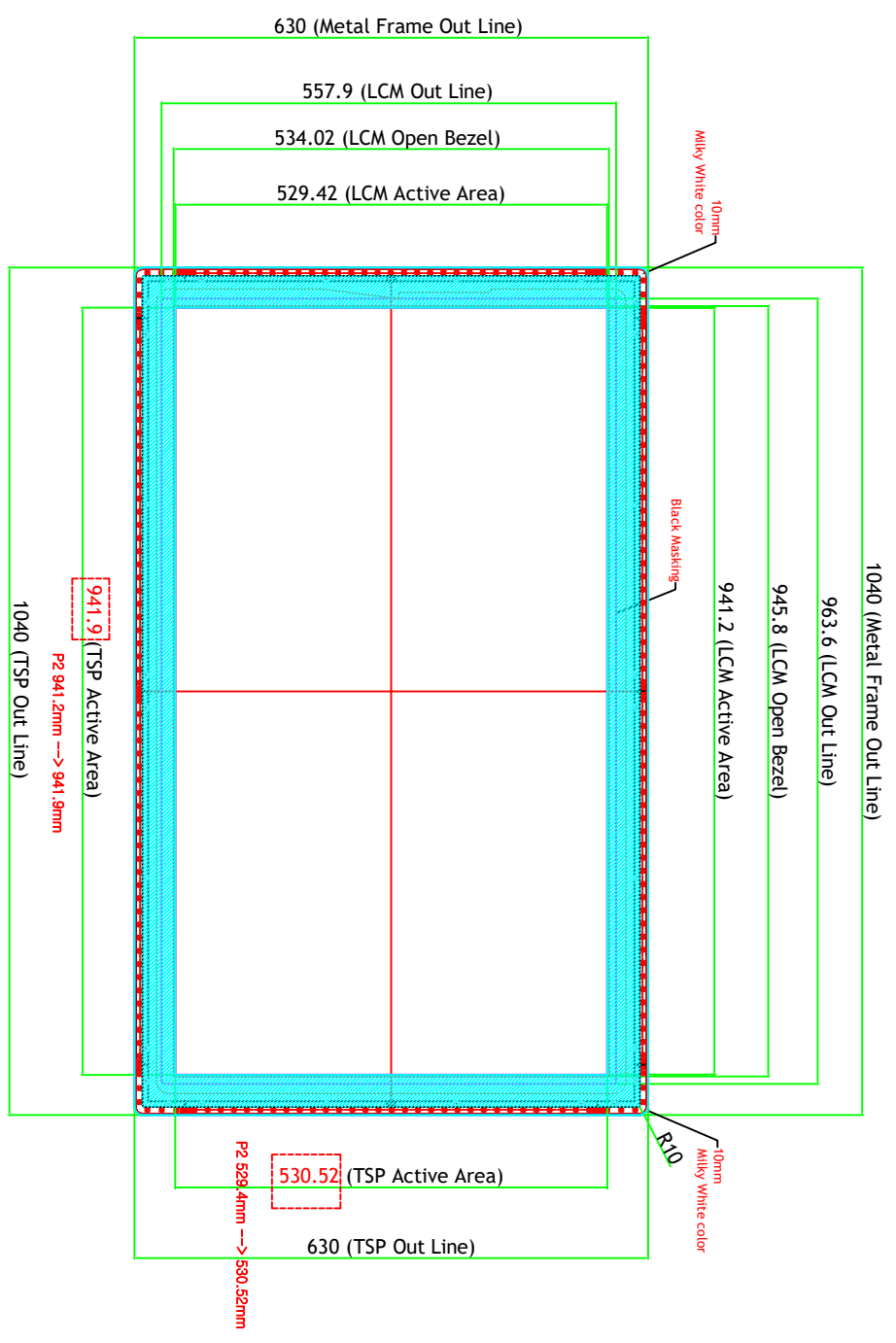

Main Frame GI = 1.2T Black Coating
Rear Cover GI = 1.0T Black Coating

LED Lighting Control Port Pin Map (wo/ IC)
#1 : Red, #2 : Green, #3 : Blue
#4 : VCC 12V, #5 : GND, #6 NC

Molex 43020-0600

		MODEL NO	150DLP4305	VIEW :		UNIT : mm
		NAME	43" Closed Frame	Qty	1	REV.
DRAWN	CHECKED	APPROVED	DWG. NO	SCALE	1 / 1	
H.I.Woo		H.Y.Sohn	4M4302017-01	DATE	2019.07.12	
			MATERIAL / FINISH	EGIT=1.2		

Rev	AMEND	DATE	CHECK	APPR.
P1	Proto	2019.05.28	H.I.Woo	H.Y.Sohn
P2	Changed Touch Active Area 941.2 x 529.4mm ----> 941.9 x 530.52mm Changed Total Thickness 66.2mm ----> 67.0mm	2019.07.12	H.I.Woo	H.Y.Sohn
P4				

Front View

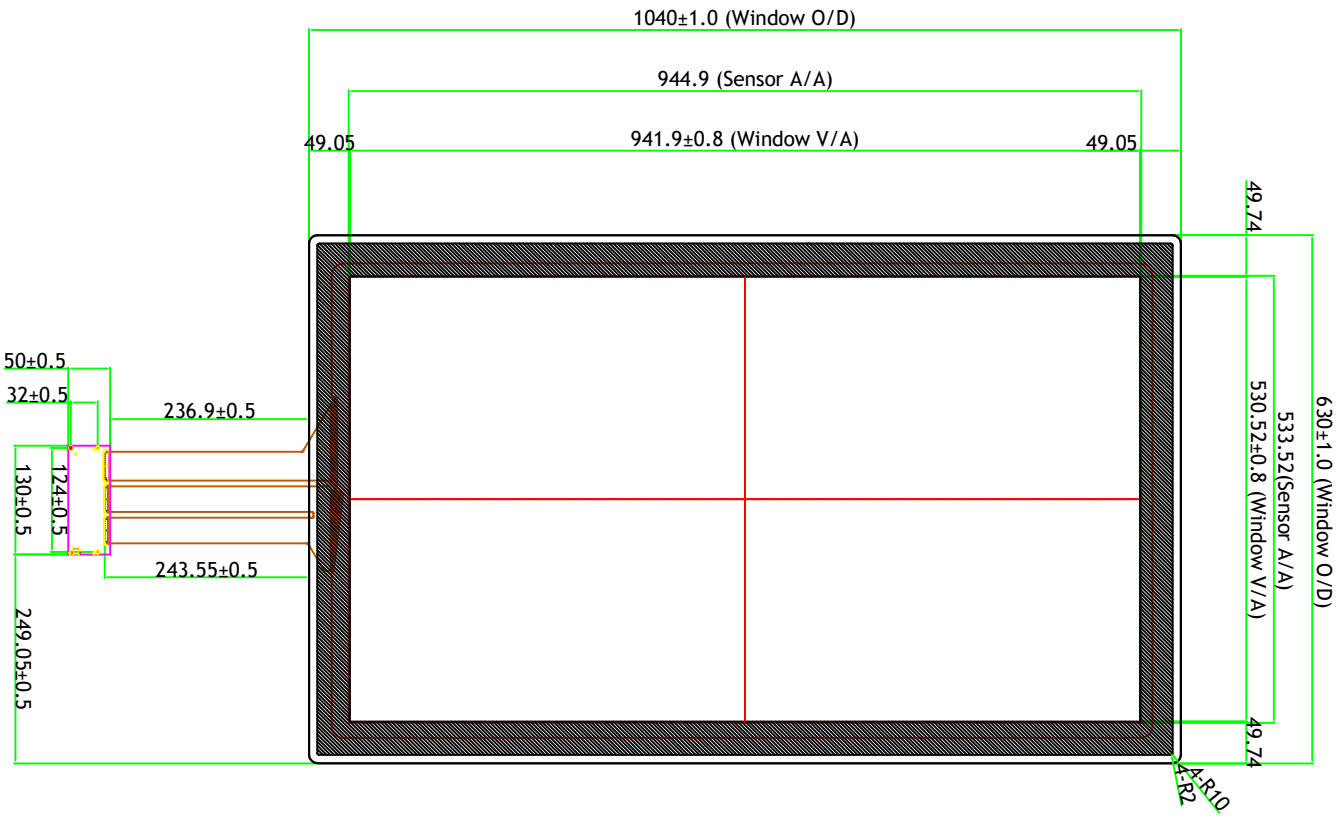

Rear View

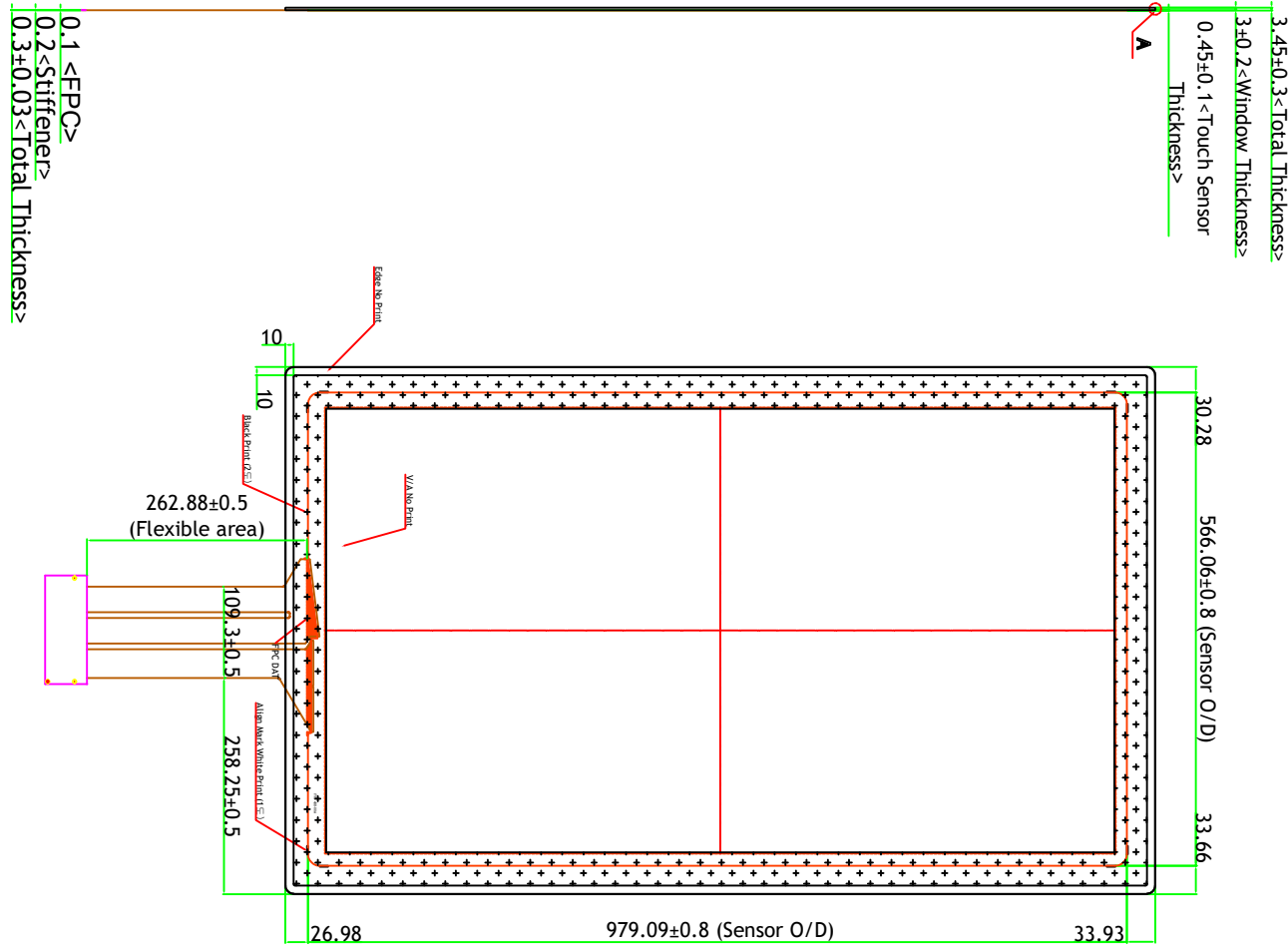

- Black Masking : 2 time
- Touch Align Masking : 1 time

43.0" FHD Edge-Lit Model Touch Glass Drawing

NOTES

- Type: GFF Capacitive Touch Panel
- Cover Window: Tempered Soda Lime 3T
- Decoration Color : Black color Printing
Edge No Printing
Align Mark White Printing
- Touch Performance: 10 Point, 8ø
- Interface : USB
- Transmittance : 88%±3%
- Surface Hardness : More than 6H
- Control Board : Silitcon Works 3 Chip Controller

Description	Material	Thickness
Cover Window	Tempered Soda Lime	3000um
Top OCA	LGH 125	125um
Top Film	ITO Film	100um
Mid OCA	LGH 125	125um
Bot Film	ITO Film	100um

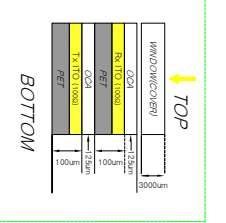

		MODEL NO	150DLP4305	VIEW :		UNIT : mm
DRAWN	CHECKED	APPROVED	DWG. NO	Q'ty	SCALE	REV.
H.I.Woo		H.Y.Sohn	4M4302017-01	1	1 / 1	P2
			MATERIAL / FINISH	DATE		
			EGI T=1.2	2019.07.12		

Main Frame GI = 1.2T Black Coating
Rear Cover GI = 1.0T Black Coating

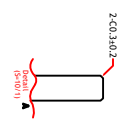

ASSEMBLY ITEM NUMBER	PART CHARACTERISTICS		MATERIAL
	NUMBER OF POSITION	PANEL MOUNT OPTION	
	43020-0200	02	
43020-0201	02	NO	
43020-0400	04	YES	
43020-0401	04	NO	
43020-0600	06	YES	
43020-0601	06	NO	
43020-0800	08	YES	
43020-0801	08	NO	
43020-1000	10	YES	
43020-1001	10	NO	
43020-1200	12	YES	
43020-1201	12	NO	
43020-1400	14	YES	
43020-1401	14	NO	
43020-1600	16	YES	
43020-1601	16	NO	
43020-1800	18	YES	
43020-1801	18	NO	
43020-2000	20	YES	
43020-2001	20	NO	
43020-2200	22	YES	
43020-2201	22	NO	
43020-2400	24	YES	
43020-2401	24	NO	

CKT. NO.	DIM. 'A'	DIM. 'B'	DIM. 'C'	DIM. 'D'
2	.152/(3.86)	N/A	.166/(4.21)	.311/(7.90)
4	.270/(6.85)	.118/(3.00)	.284/(7.21)	.429/(10.90)
6	.388/(9.85)	.236/(6.00)	.402/(10.21)	.547/(13.89)
8	.506/(12.85)	.354/(9.00)	.520/(13.21)	.665/(16.89)
10	.624/(15.85)	.472/(12.00)	.638/(16.21)	.783/(19.89)
12	.742/(18.85)	.591/(15.00)	.756/(19.21)	.901/(22.89)
14	.860/(21.85)	.709/(18.00)	.874/(22.20)	1.019/(25.88)
16	.978/(24.85)	.827/(21.00)	.992/(25.20)	1.137/(28.88)
18	1.096/(27.85)	.945/(24.00)	1.110/(28.20)	1.255/(31.88)
20	1.215/(30.85)	1.063/(27.00)	1.229/(31.22)	1.373/(34.87)
22	1.333/(33.85)	1.181/(30.00)	1.347/(34.22)	1.491/(37.87)
24	1.451/(36.85)	1.299/(33.00)	1.465/(37.22)	1.609/(40.87)

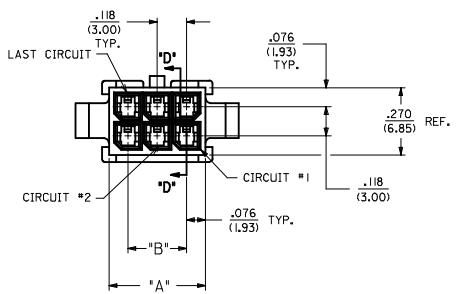

- NOTES:
- HOUSING MATERIAL:
 - 'A' - UNFILLED POLYESTER, RATED U.L. 94V-0, COLOR IS BLACK.
 - 'B' - UNFILLED NYLON, RATED U.L. 94V-0, HALOGEN-FREE, COLOR IS BLACK.
 - FINISH: N/A
 - PRODUCT SPECIFICATION: PS-43045
 - PACKAGING SPECIFICATION: PK-43020-001
 - THIS HOUSING MATES WITH MICRO-FIT RECEPTACLE #43025-****
 - THIS HOUSING TO BE USED WITH MOLEX MALE TERMINAL #43031-****
 - DESIGNED FOR .055(1.4) MINIMUM TO A .100(2.54) MAXIMUM THICK PANEL OR PRINTED CIRCUIT BOARD.
 - SEE SECTION 'D'-D' FOR TERMINAL ORIENTATION IN HOUSING.
 - PANEL MOUNT FEATURES MUST LOCK ON SIDE OPPOSITE PUNCH SIDE FOR OPTIMUM RETENTION.
 - PART CONFORMS TO CLASS 'B' REQUIREMENTS OF COSMETIC SPECIFICATION PS-45499-002. SOME HOUSINGS MAY HAVE A SMALL GATE BLEMISH NEAR THE GATE LOCATION THAT DOES NOT AFFECT FUNCTIONALITY.

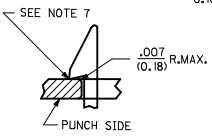
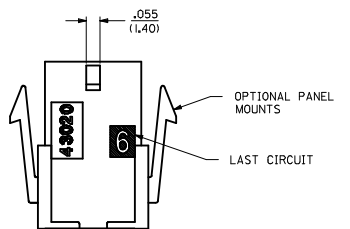
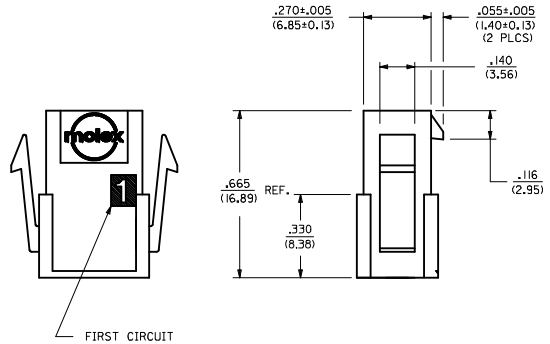
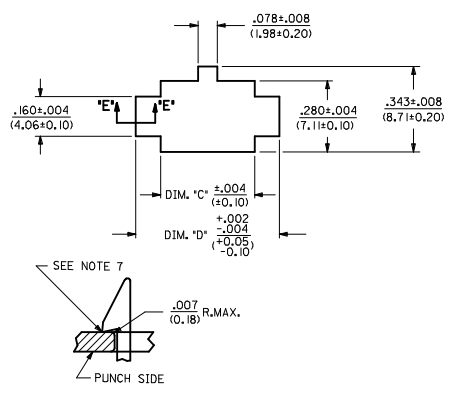

SECTION "E"-E
NO SCALE

RECOMMENDED PANEL CUT-OUT
(SEE NOTES 7 & 9)

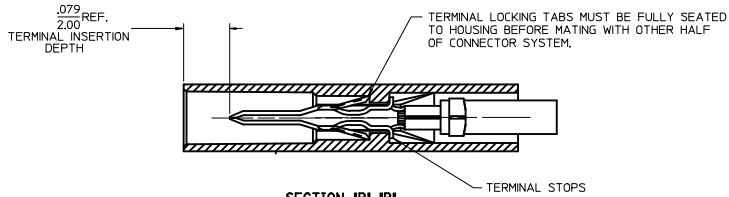

SECTION "B"-B'

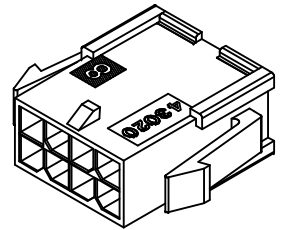

PLUG WITH OPTIONAL
PANEL MOUNTS
ISO VIEW
(8 CIRCUIT SHOWN)

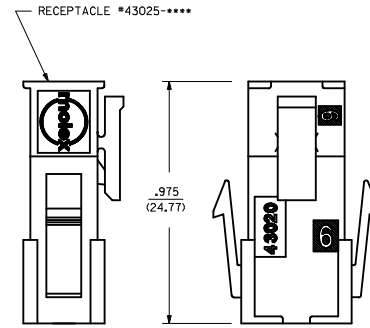

MATED MICRO-FIT CONNECTOR

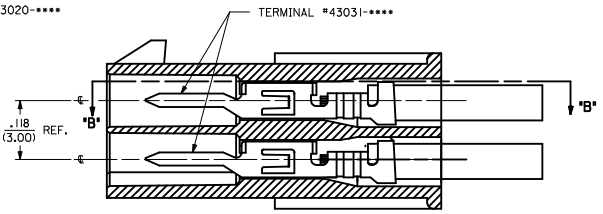

SECTION "D"-D'
WITH TERMINAL
SCALE 8X

UPDATE PUNCHED HOLE DEC NO. UCP2017-0525 DRAWN/OUTLES 2016/09/13 CHKD/SSOUSEK 2016/09/13 APPR/FSM TH 2016/10/07	QUALITY SYMBOLS ▽=0 ▽=0 ▽=0	GENERAL TOLERANCES (UNLESS SPECIFIED)		DIMENSION STYLE		SCALE	DESIGN UNITS	THIRD ANGLE PROJECTION
		mm	INCH	IN/MM		METRIC		
		4 PLACES ±.010	±.010	DRAWN BY	DATE			
		3 PLACES ±.014	±.014	CHECKED BY	DATE			
		2 PLACES ±0.25	±.014	BAP	1993/01/07			
		1 PLACE ±0.35	±.014	APPROVED BY	DATE			
		0 PLACE ±---	±---	FSMITH	2016/10/07			
		ANGULAR ±1/2°		MATERIAL NO.				
		DRAFT WHERE APPLICABLE MUST REMAIN WITHIN DIMENSIONS		SEE CHART				
				DOCUMENT NO.				
				SDA-43020-****				
				SHEET NO.				
				1 OF 1				

PART CHARACTERISTICS		
NUMBER OF POSITION	ASSEMBLY ITEM NUMBER	MATERIAL
02	43025-0200	'B'
04	43025-0400	
06	43025-0600	
08	43025-0800	
10	43025-1000	'A'
12	43025-1200	
14	43025-1400	'B'
16	43025-1600	'A'
18	43025-1800	'B'
20	43025-2000	
22	43025-2200	'A'
24	43025-2400	

CKT. NO.	DIM. "A" +0.14 -0.10 +0.35 -0.25	DIM. "B"
2	.152/(3.86)	N/A
4	.270/(6.85)	.118/(3.00)
6	.388/(9.85)	.236/(6.00)
8	.506/(12.85)	.354/(9.00)
10	.624/(15.85)	.472/(12.00)
12	.742/(18.85)	.591/(15.00)
14	.860/(21.85)	.709/(18.00)
16	.978/(24.85)	.827/(21.00)
18	1.096/(27.85)	.945/(24.00)
20	1.215/(30.85)	1.063/(27.00)
22	1.333/(33.85)	1.181/(30.00)
24	1.451/(36.85)	1.299/(33.00)

- NOTES:**
- HOUSING MATERIAL:
"A" - UNFILLED POLYESTER, RATED UL, 94V-0, COLOR IS BLACK.
"B" - UNFILLED NYLON, RATED UL, 94V-0, HALOGEN-FREE, COLOR IS BLACK.
 - FINISH: N/A
 - PRODUCT SPECIFICATION: PS-43045
 - PACKAGING SPECIFICATION: PK-43025-001
 - THIS RECEPTACLE MATES WITH 43020, 43045.
 - THIS RECEPTACLE TO BE USED WITH MOLEX FEMALE TERMINAL SERIES 43030 OR 46235. SEE SECTION "A"- "A" FOR TERMINAL ORIENTATION IN HOUSING.
 - FOR OVERMOLDING PARAMETERS SEE ENGINEERING SPECIFICATION #SDS-43025-1000.
 - TOP PULL TABS ARE NOT AVAILABLE ON 2 AND 4 CIRCUIT PARTS.
 - MOLEX RECOMMENDS THE USE OF MICRO-FIT TEST PLUG, SERIES NO. 44242-***** WHENEVER TESTING IS PERFORMED. TEST PLUGS MUST NOT BE USED FOR MAKE OR BREAK UNDER LOAD. MOLEX DOES NOT RECOMMEND USING STANDARD MATING COMPONENTS FOR HARNESS TESTING PURPOSES.
 - SOME HOUSINGS MAY HAVE A SMALL GATE BLEMISH NEAR THE GATE THAT DOES NOT AFFECT FUNCTIONALITY.
 - HOUSINGS HAVE EITHER AN IDENTIFIER RIB OR ENGRAVED "1" SYMBOL TO INDICATE CIRCUIT #1. IDENTIFIER TYPE IS TOOL DEPENDENT AND NOT SELECTABLE.
 - DIMENSION "A" MEASURED AT DATUM \square -A-
 - THIS PART CONFORMS TO CLASS "B" REQUIREMENTS OF COSMETIC SPECIFICATION PS-45499-002.

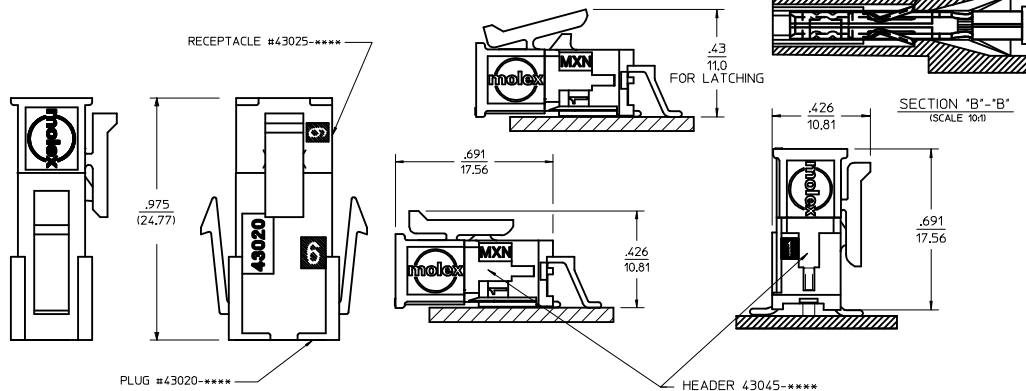
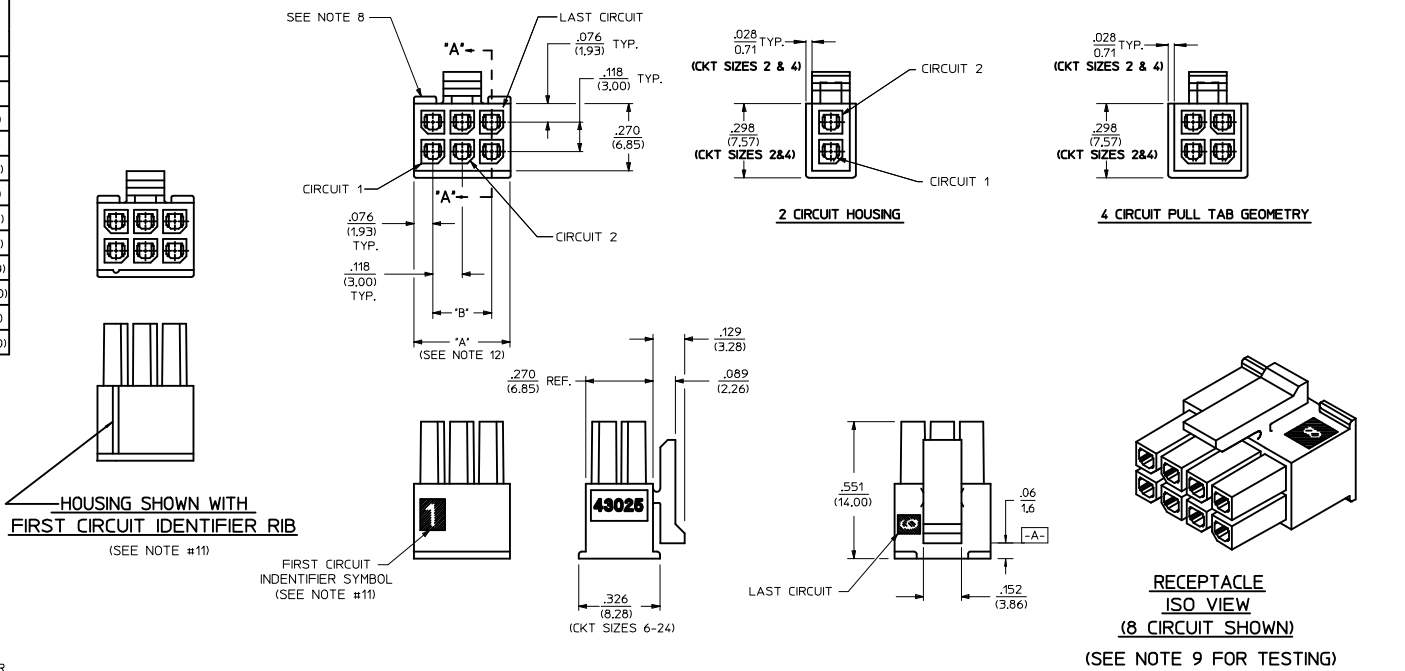

MATED MICRO-FIT CONNECTOR

ADD MATED VIEW IEC NO: UCP2016-4677 DRAWN BY: DRYNWAPELDOORN CHYKJDFOX APPROVED BY: FSMTTH DATE: 2016/06/03 DATE: 2016/06/09	QUALITY SYMBOLS	GENERAL TOLERANCES (UNLESS SPECIFIED)	DIMENSION STYLE	SCALE	DESIGN UNITS	THIRD ANGLE PROJECTION
	▽=0	4 PLACES ±.010	IN/MM	DATE	METRIC	
	▽=0	3 PLACES ±.025		1993/01/14		
	▽=0	1 PLACE ±.035		DATE		
04	DESCRIPTION	ANGULAR ±1/2°	DRAWN BY	DATE	TITLE	
		DRAFT WHERE APPLICABLE MUST REMAIN WITHIN DIMENSIONS	A. F. G.	1993/01/14	MICRO-FIT (3.0) 2 THRU 24 CIRCUIT RECEPTACLE	
			B. A. P.	1993/01/14		
			APPROVED BY	DATE		
			FSMITH	2016/05/02		
			MATERIAL NO.	DOCUMENT NO.		
			SEE CHART	SDA-43025-*****		
			SIZE			
			D			
			THIS DRAWING CONTAINS INFORMATION THAT IS PROPRIETARY TO MOLEX INCORPORATED AND SHOULD NOT BE USED WITHOUT WRITTEN PERMISSION			
						SHEET NO. 1 OF 1