

| Rev | AMEND | DATE | CHECK | APPR. |
|-----|-------|------------|---------|----------|
| P1 | Proto | 2019.09.02 | H.I.Woo | H.Y.Sohn |
| P2 | | | | |
| P3 | | | | |

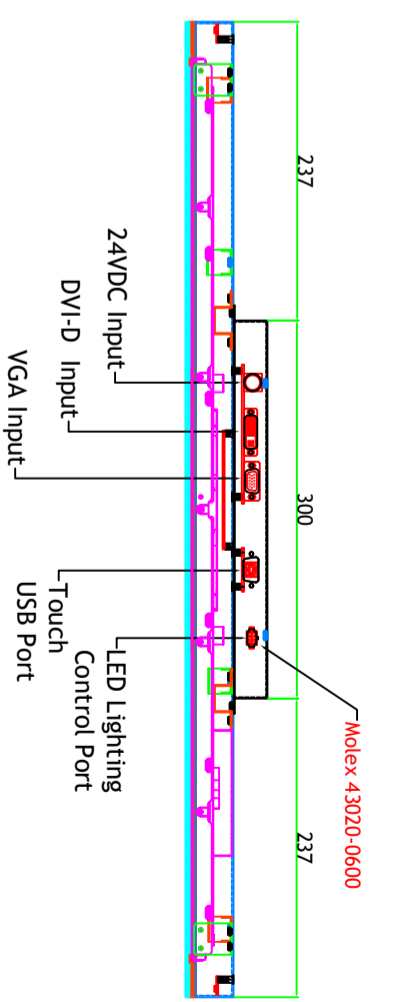

LED Lighting Control Port Pin Map (w/ IC)

- #1 : 5V, #2 : CTL, #3 : GND
- #4 : 5V, #5 : NC, #6 : GND

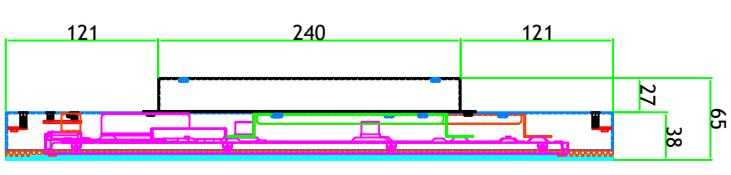
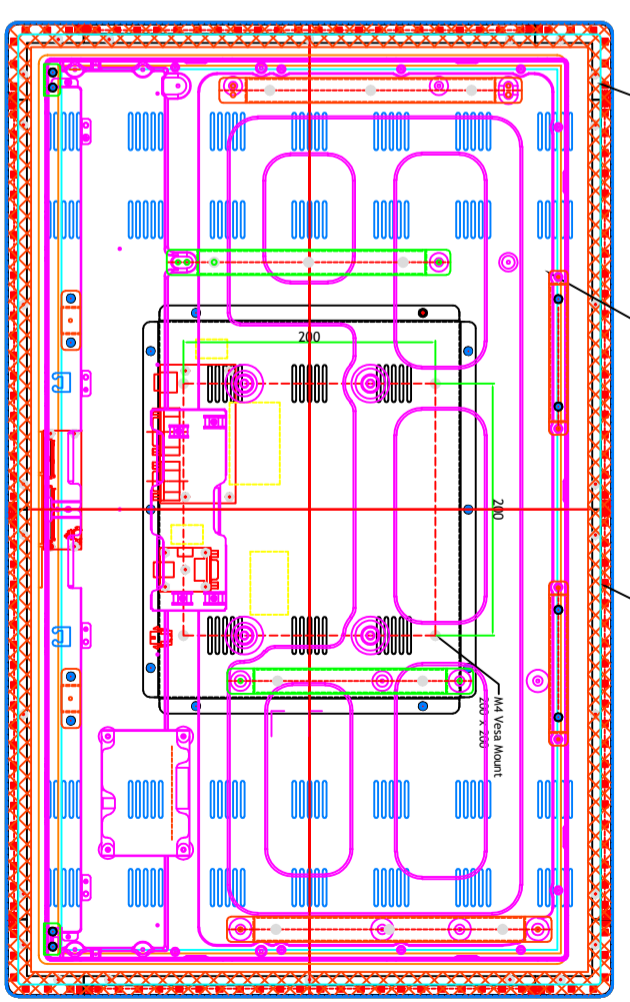
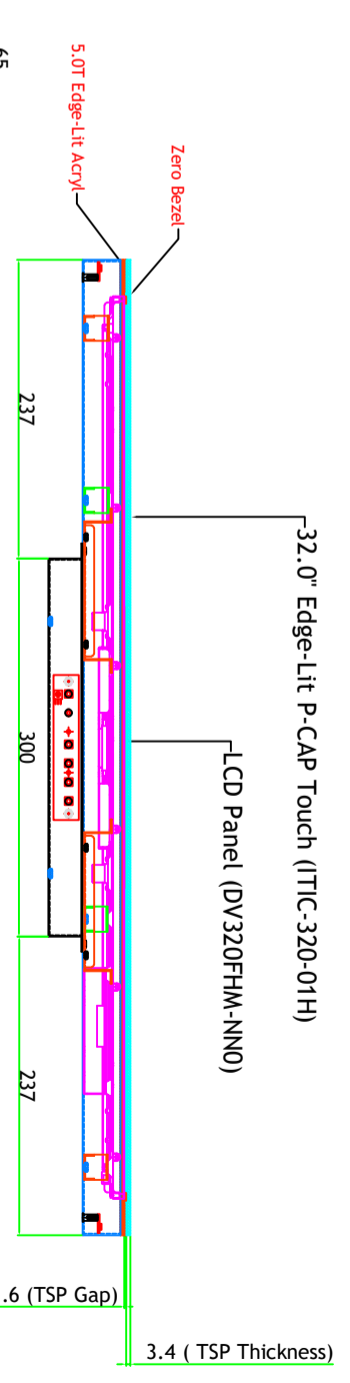
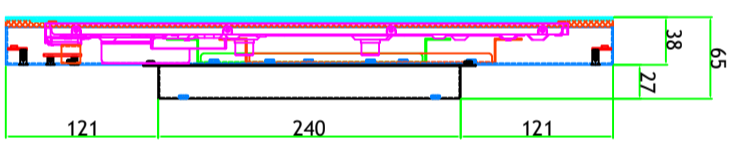
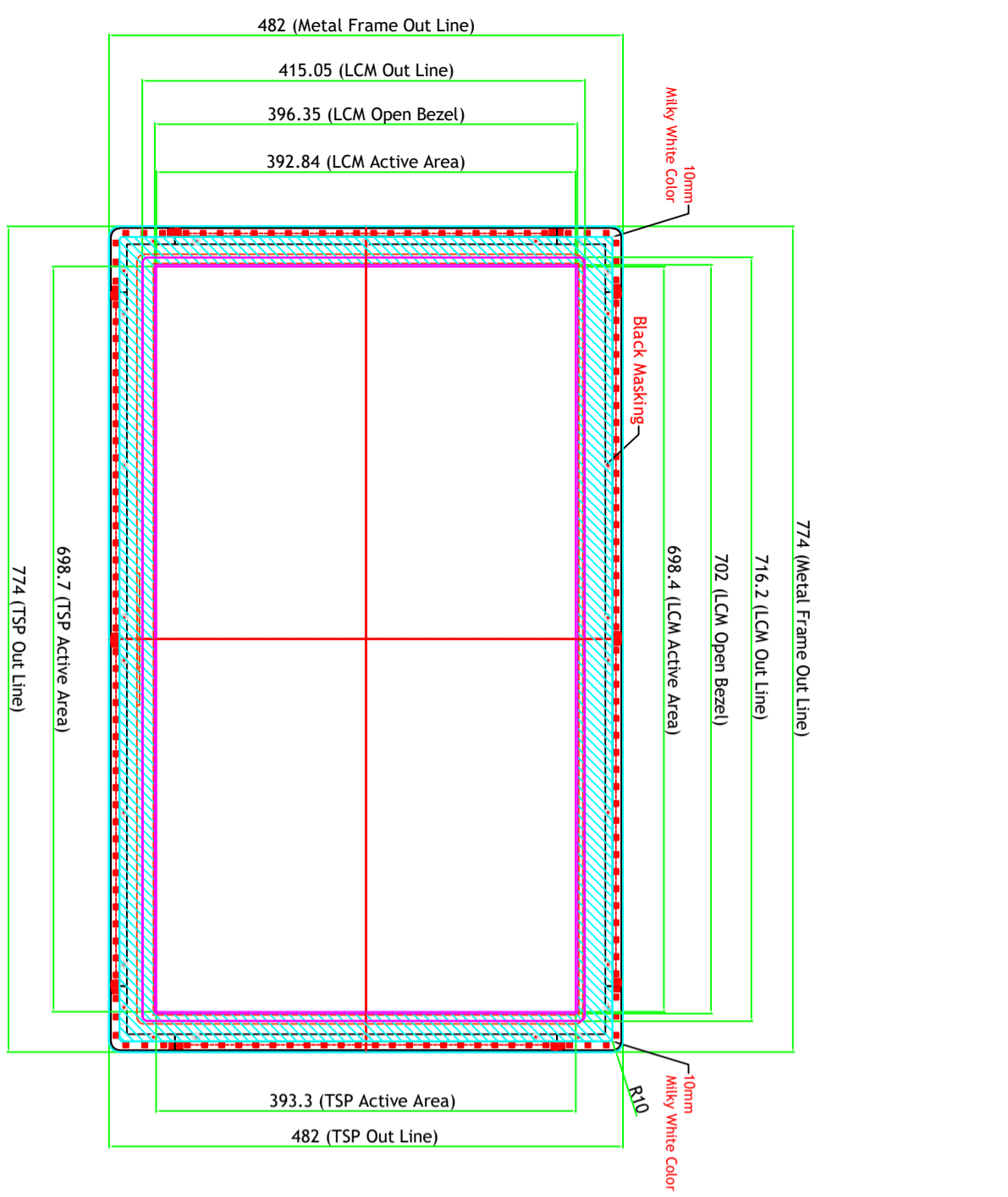
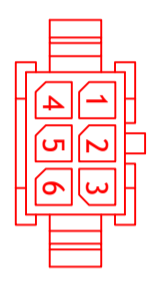

Molex 43020-0600



Main Frame GI = 1.2T Black Coating
Rear Cover GI = 1.0T Black Coating

| | | | | | | |
|----------|------------------|----------|-------------------|--------------|-------|------------|
| SUZOHAPP | | MODEL NO | 150DLP3206 | | VIEW | UNIT |
| NAME | 32" Closed Frame | | Q'ty | 1 | REV. | P1 |
| DRAWN | CHECKED | APPROVED | DWG. NO | 4M3203041-00 | SCALE | 1 / 1 |
| H.I.Woo | | H.Y.Sohn | MATERIAL / FINISH | EGI T=1.2 | DATE | 2019.09.02 |

| Rev | AMEND | DATE | CHECK | APPR. |
|-----|-------|------------|---------|----------|
| P1 | Proto | 2019.09.02 | H.I.Woo | H.Y.Sohn |
| P2 | | | | |
| P3 | | | | |

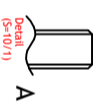

Front View

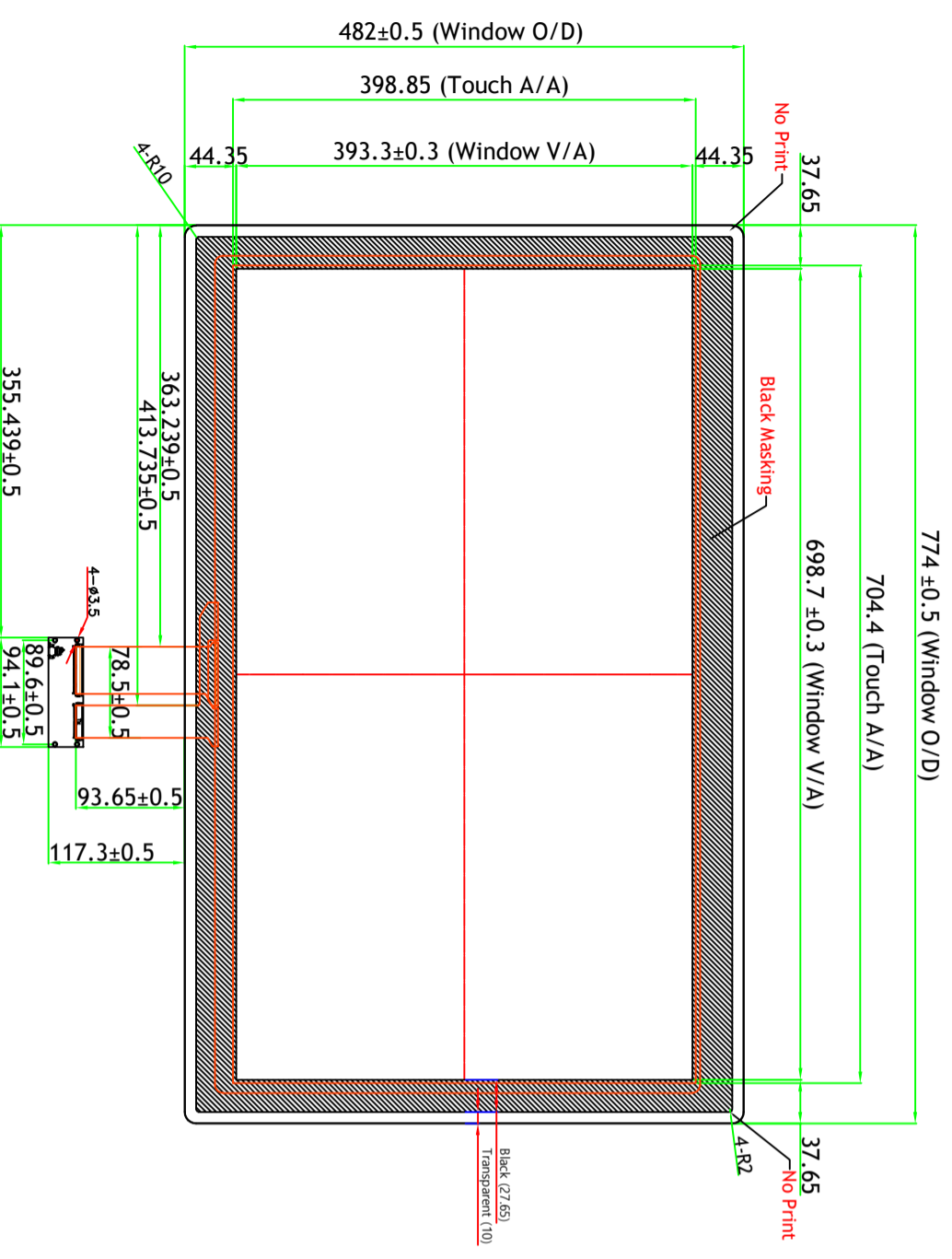

Rear View

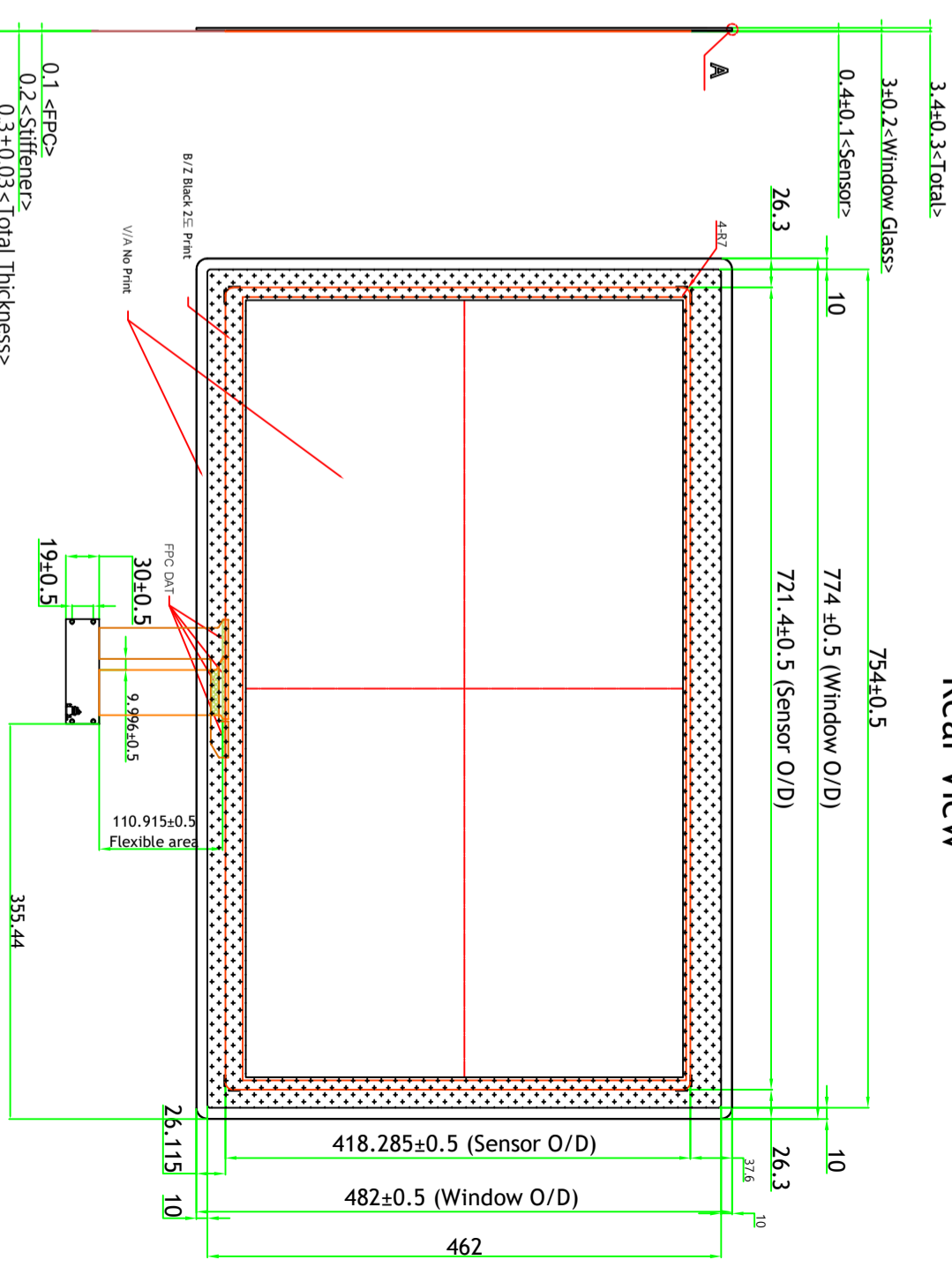

- Black Masking : 2 time
- Touch Align Masking : 1 time

32.0" Edge-Lit Model Touch Glass Drawing

NOTES

1. Type: GFF Capacitive Touch Panel
2. Cover Window : Tempered Soda Lime 3.0T
3. Touch Performance: 10 Point, 9 ϕ
4. Interface : USB
5. Window Decoration Color : Black Color Printing
6. Transmittance : 88% \pm 3%
7. Surface Hardness : More than 6H
8. Control Board : Silicon Works

| Description | Material | Thickness |
|--------------|--------------------------|--------------|
| Cover Window | Tempered Soda Lime | 3000 μ m |
| Top OCA | Optically Clear Adhesive | 100 μ m |
| Top Film | ITO Film | 100 μ m |
| Mid OCA | Optically Clear Adhesive | 100 μ m |
| Bot Film | ITO Film | 100 μ m |

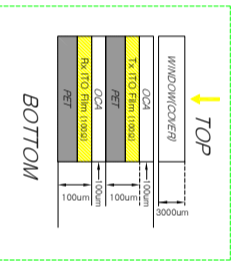

| | | | | | | |
|----------|---------|-------------------|--------------|-------|-------|------------|
| SUZOHAPP | | MODEL NO | 150DLP3206 | VIEW | UNIT | mm |
| DRAWN | CHECKED | APPROVED | DWG. NO | Q'ty | REV. | P1 |
| H.I.Woo | | H.Y.Sohn | 4M3203041-00 | 1 | 1 / 1 | |
| | | MATERIAL / FINISH | EGI T=1.2 | SCALE | DATE | 2019.09.02 |