

Rev	AMEND	DATE	CHECK	APPR.
P1	Proto	2019.09.02	H.I.Woo	H.Y.Sohn
P2				
P3				

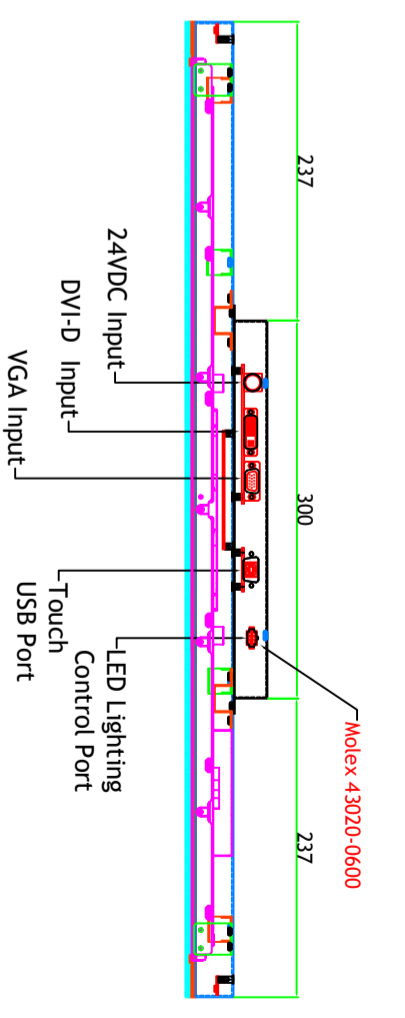

LED Lighting Control Port Pin Map (w/o IC)
 #1 : Red, #2 : Green, #3 : Blue
 #4 : VCC 12V, #5 : GND, #6 NC

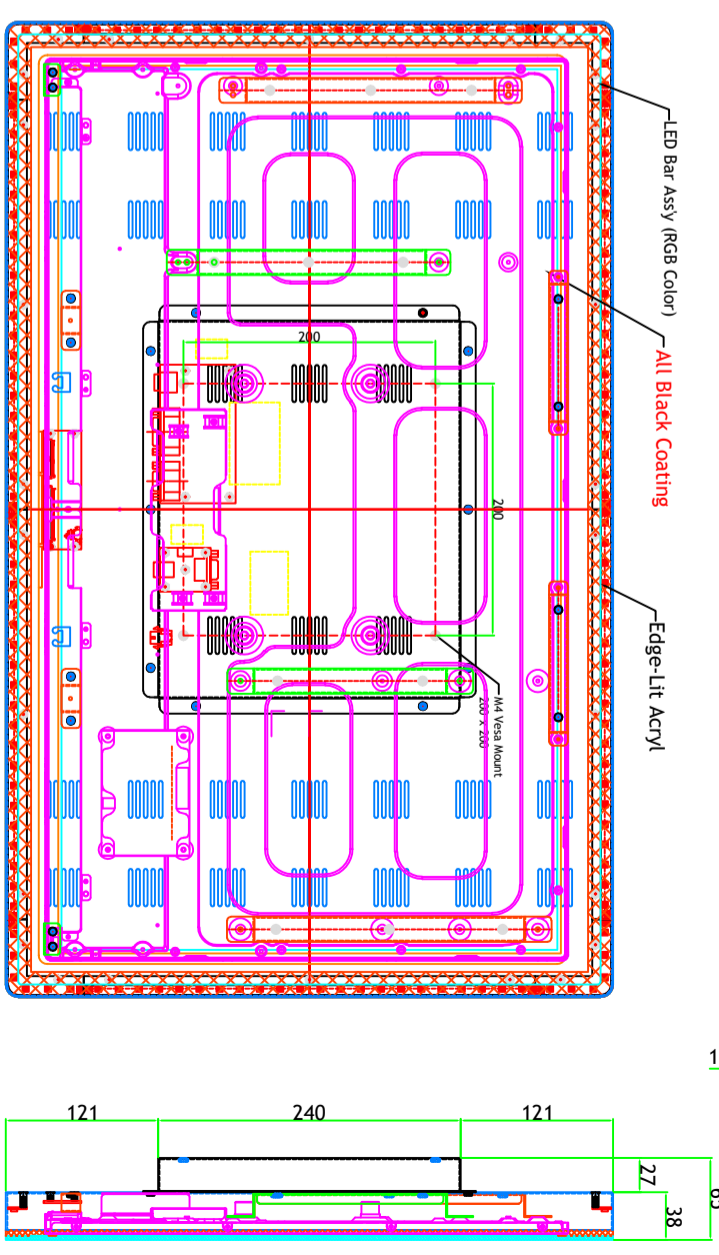
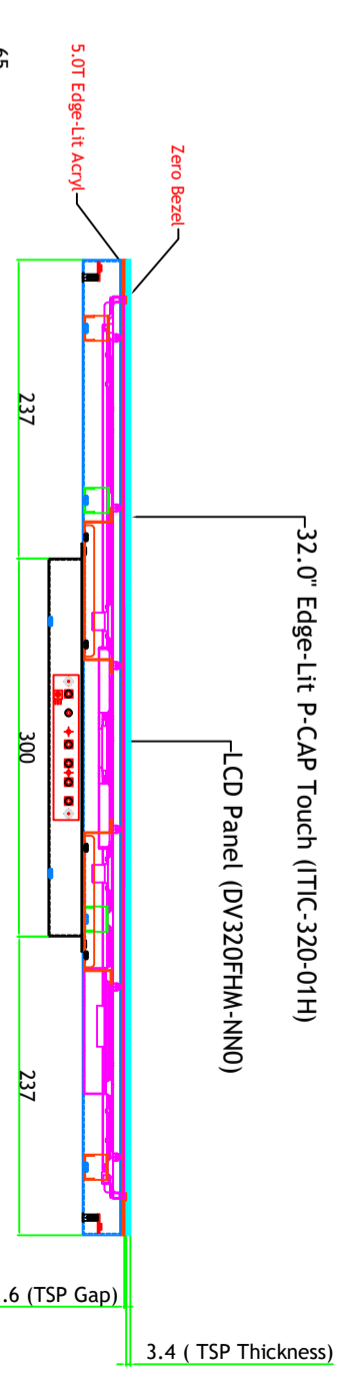
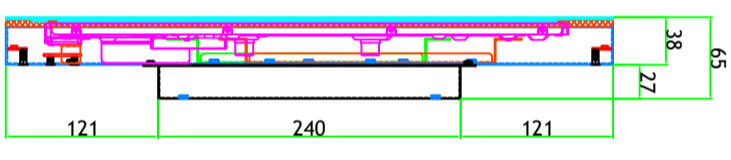
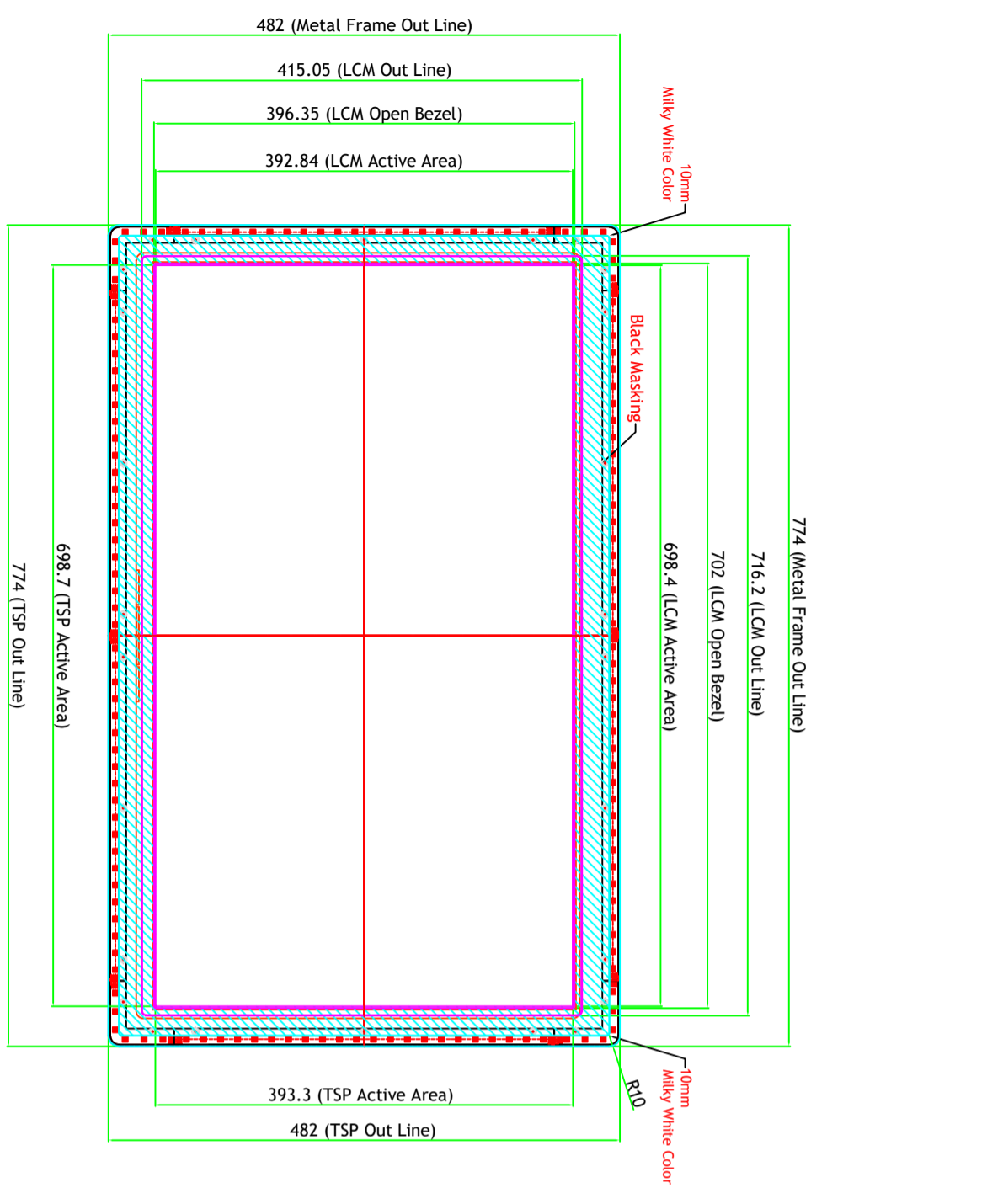
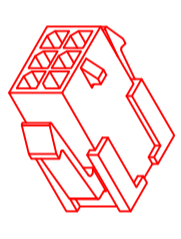
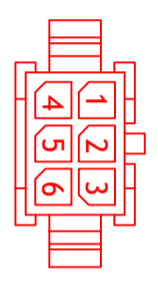

Molex 43020-0600

Main Frame GI = 1.2T Black Coating
 Rear Cover GI = 1.0T Black Coating

SUZOHAPP		MODEL NO	150DLP3205	VIEW	UNIT	mm
NAME	32" Closed Frame	QTY	1	REV.	P1	
DRAWN	CHECKED	APPROVED	DWG. NO	SCALE	1 / 1	
H.I.Woo		H.Y.Sohn	4M3203041-00	DATE	2019.09.02	
MATERIAL / FINISH		EGI T=1.2				

