

MODEL : 150DLG3206

Zero Bezel with Printed Tempered Glass
 LED Illumination on Edge and Front, 4 Sides
 5V Addressable LEDs, w/ IC

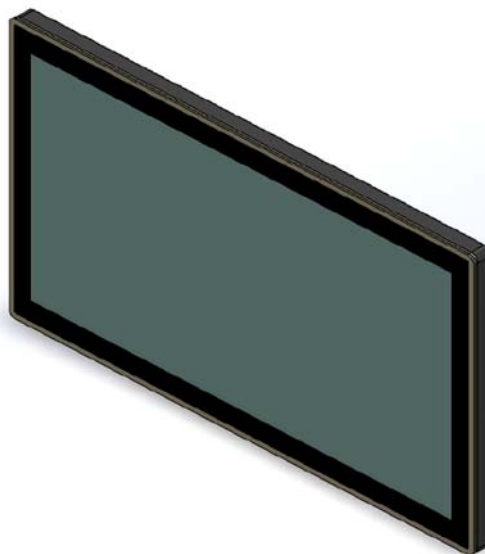

| Revision | Date | History |
|----------|------------|------------------|
| V0.1 | 2019.09.02 | Initial Release. |
| | | |
| | | |
| | | |
| | | |

Draft _____

Date : _____

Checked: _____

Date : _____

Approved : _____

Date : _____

Contents

1. General Description

- 1.1 Overview
- 1.2 General Specifications
- 1.3 Environmental and Reliability Specification
- 1.4 Power Supply Rating
- 1.5 Input/Output Port

2. User Control & OSD

- 2.1 Key Control Board
- 2.2 OSD Control Function

3. Connector Description

- 3.1 Summary
- 3.2 J6: 24VDC Power Input Connector
- 3.3 J8: Auto Dimming/RS232 Connector
- 3.4 J1: Backlight Inverter Connector
- 3.5 J15: OSD Board Connector
- 3.6 J2: 12VDC/5VDC External Output Connector
- 3.7 J4: 24VDC Input Jack
- 3.8 J11: DVI Input Connector
- 3.9 J23: VGA Input Connector
- 3.10 J14: LCD Interface Connector

4. Standard Display Modes

5. LED Backlight Driver Board Specification

6. Board Dimensions

7. LED Lighting Control Specification

8. Packing Information

9. Mechanical Structure

1. General Description

1.1 Overview

- ◆ SUZOHAPP Closed-frame LCD Monitor 150DLG3206 is a high performance TFT LCD monitor providing a high quality screen image.
- ◆ This monitor supports VGA and DVI input. Other input options are available.
- ◆ Wide input resolution range up to Full HD (1920 x 1080@60Hz).
- ◆ It is designed for industrial use with Auto power on, up scaling performance adequate for low-resolution applications and enhanced design margin for reliability.
- ◆ It is available in matching touch and non-touch designs.

1.2 General Specifications

| | | |
|-------------------------|-------------------------------------|--|
| LCD Panel | Size | 31.5" Diagonal |
| | Active Display Area | 698.4(H) x 392.85(V)mm |
| | Type No. | BOE DV320FHM-NN0 |
| | Number of Pixels | 1920 (H) x 1080 (V) |
| | Pixel Arrangement | RGB Vertical Stripe |
| | Pixel Pitch | 0.36375mm x 0.36375mm |
| | Color Depth | 16.7M True Colors |
| | Surface Treatments | Haze 1% |
| | Viewing Angle (CR>10) | R/L: 178 degree (89/89) U/D: 178 degree (89/89) |
| | Contrast Ratio | Typ. 1200 : 1 |
| | Response Time(Typ.) | 8.0ms |
| | Average Brightness | Typ. 400 cd/ m ² |
| | Frame Rate | Typ. 60Hz |
| | Backlight Unit | LED |
| Input Resolution | Prime | 1920 x 1080 @ 60 Hz |
| | Standard | 640x480 @60Hz/70Hz/75Hz 800x600 @56/60/72/75 Hz, 1024x768 @60/70/75 Hz, 1280x1024 @60/75 Hz, 1280x720@60Hz 1366x768@60Hz,1600x900@60Hz, 1680x1050@60Hz,1920x1080@60Hz |

| | | |
|--|------------|---|
| Input Signal Port | VGA | 15pin D-Sub x 1Port |
| | DVI-D | 24pin DVI-D x 1 Port |
| | Power Jack | Power Mini-Din 4P x 1 Port |
| Scanning Frequency | Horizontal | 31 ~ 80Khz |
| | Vertical | 55 ~75Hz |
| OSD Control | | Menu, Select, Up, Down, Power |
| Plug & Play | | VESA DDC 2B Ver1.3 |
| Safety Glass | | Tempered Glass 744.0mm x 482.0mm x 3.0T |
| LED Frame Illumination (Without Controller) | | Edge / Front Type, 4 sided |
| | | LED Type : Dual Line w/IC type (BT5050B) |
| | | Supports External 5V Addressable, w/IC type LED Lighting Controller |
| | | Interface Port : Molex 43020-0600 |
| RoHS | | RoHS2 Compliance |
| Mounting Options | | 200 x 200mm M4 VESA Mounting Holes |
| Optional Accessories | | Cables, Power Supply <for Addressable style, also say LED Lighting Controller> |



Application Caution

- 1. Precautions for strong light exposure.**
Strong light exposure causes degradation of polarizer and color filter.

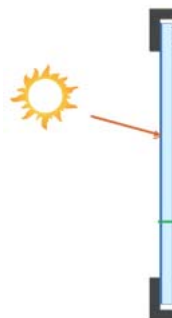

- 2. Using Conditions.**
- Temperature inside the cabinet should be controlled 'at room temp' (0 ~ 40°C) by cooler and fan.

1.3 Environmental and Reliability Specification

- This specification depends on the LCD panel characteristics. Please refer to the manufacturer’s panel specification for details.

| Item | Symbol | Min | Max | Unit |
|-----------------------|--------|-----|-----|------|
| Operating Temperature | TOP | 0 | +50 | °C |
| Operating Humidity | HOP | 10 | 80 | % |
| Storage Temperature | TST | -20 | +60 | °C |
| Storage Humidity | HST | 10 | 80 | % |

1.4 Power Supply Rating

| | | | | |
|--|-------------------------|------|------|------|
| Optional PSU Input Voltage | AC 100 ~ 240VAC,50/60Hz | | | |
| Optional PSU Output Voltage | DC 24V/5.0A | | | |
| Monitor DC Input Voltage | 24VDC | | | |
| Power Consumption | TBD | | | |
| LED String Lighting Specification (5V Addressable, w/IC type) | Min | Typ. | Max | Unit |
| Input Voltage | 4.75 | 5.0 | 5.25 | [V] |
| Input Current | | 7.6 | | [A] |
| Power Consumption | | 38.0 | | [W] |

- Conditions of Measurement
 - 1) LED pattern: LED Bar full white light, non-scrolling.
 - 2) Current consumption tolerance: + 10%.

1.5 Input/Output Port

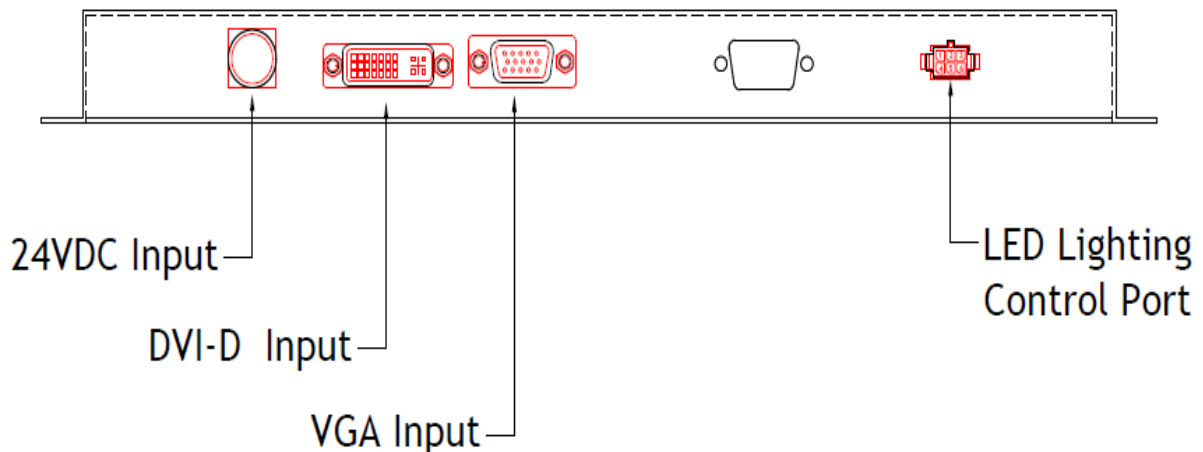

2. User Control & OSD

2.1 Key Control Board

K002

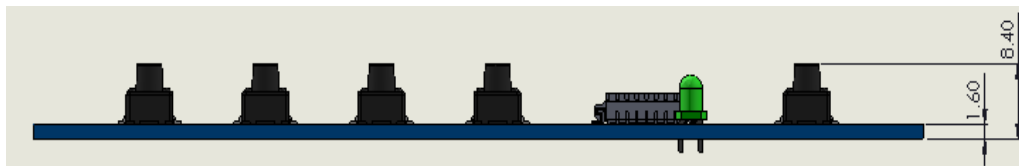
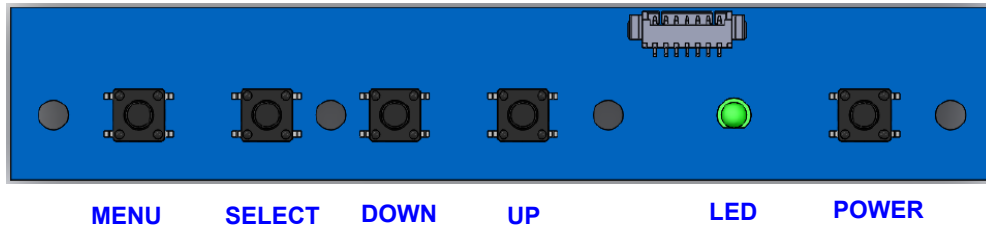

| Button | Function | Status | HOT Key |
|--------|---|--|---------------------------------------|
| LED | Indicates operation status | Green : Normal State Red : Off Mode Green Blinking : DPMS Mode | |
| POWER | Power on/off | | |
| MENU | Enable MENU Window Disable MENU Window Exit from Sub function | | |
| SELECT | Select function | | No OSD Window, Input Source Change |
| DOWN | Move to Down or Left | | No OSD Window, Auto Color |
| UP | Move to Up or Right | | No OSD Window, Auto Configuration |

2.2 OSD Control Function

The chosen OSD settings will be stored in memory. The OSD menu can be cleared from the screen by pressing the **MENU** button otherwise it will be automatically cleared after a few second of non-use.

2.2.1 OSD Main Menu

1) PICTURE

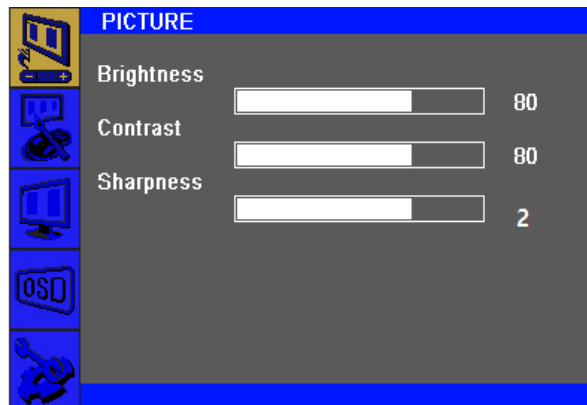

| | |
|----------------------|--|
| Brightness (0 ~ 100) | Increases/decreases monitor Brightness. Default: 100 |
| Contrast (0 ~ 100) | Increases/decreases monitor Contrast. Default: 100 |
| Sharpness (0 ~ 4) | Adjusts Sharpness of the displayed images. Default : 2 |

2) COLOR



| | |
|-------------------------|--|
| Color Status Management | Selects the display's color temperature. The available color settings "Normal", "Warm", "Cool", "User", "Game" mode. Default : User |
| Red (0 ~ 100) | Increases/decreases Red Color Temperature. Default : 50 |
| Green (0 ~ 100) | Increases/decreases Green Color Temperature. Default : 50 |
| Blue (0 ~ 100) | Increases/decreases Blue Color Temperature. Default : 50 |
| Auto Color | Automatically adjusts the system color to the input VGA. |

3) SCREEN (VGA input only)

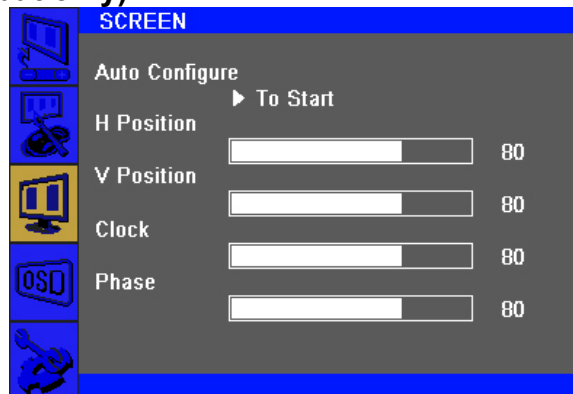

| | |
|----------------------|---|
| Auto Configure | Automatically adjusts the system clock to the input VGA. |
| H Position (0 ~ 100) | Moves the image horizontally on the display in single-pixel increments. Default : 50 |
| V Position (0 ~ 100) | Moves the image vertically on the display in single-pixel increments. Default : 50 |
| Clock (0 ~ 100) | Allows fine adjustments of the panel's pixel dot clock. Default : 50 |
| Phase (0 ~ 100) | Allows fine adjustments of the panel's pixel dot clock phase. Default : 50 |
| WXGA Mode | Selects WXGA Mode Off, 1024 x 768, 1280 x 768, 1360 x 768, 1366 x 768 Default : Off |

4) OSD

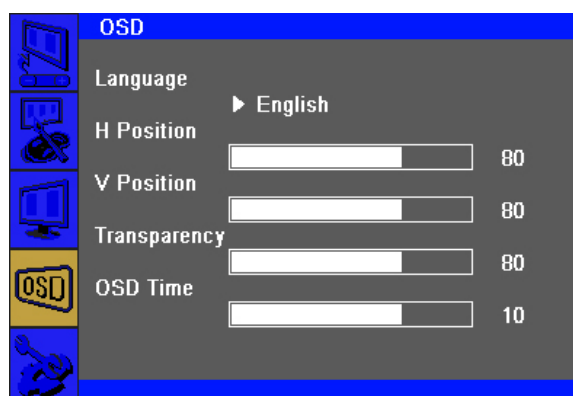

| | |
|----------------------|---|
| Language | Selects the OSD's display language. The available languages are English, Deutsch, Français, Italiano, Español, Korean. Default : English |
| H Position (0 ~ 100) | Adjusts the horizontal location of the OSD menus on the display. Default : 50 |

| | |
|------------------------|---|
| V Position (0 ~ 100) | Adjusts the vertical location of the OSD menus on the display. Default : 50 |
| Transparency (0 ~ 100) | Adjusts the transparency of the OSD menus on the display. Default : 33 |
| OSD Time (0 ~ 60) | Adjusts how long the touch monitor will wait without OSD button activity before closing the OSD. The adjustable range is between 0 and 60 seconds. Default : 10 |

5) SETUP



| | |
|---------------|--|
| Source | Selects Input Source VGA (RGB), DVI. |
| Factory reset | Restores all factory default settings for OSD-adjustable parameters and for Preset Video Mode timings. |
| Aspect | Switches the scaling method between Full Scaling and Maintain Aspect Ratio. Default : Off |

3. Connector Description

3.1 Summary

| Reference | Item | Description | Type | Manufacture |
|-----------|-----------|--|-------------|-------------|
| J6 | Connector | External 24VDC Power Input Connector | 20010WS-04 | YEONHO |
| J8 | Connector | Auto-Dimming/RS232 Connector | SMW200-04 | YEONHO |
| J1 | Connector | Backlight Inverter Connector | SMAW200-8 | YEONHO |
| J15 | Connector | OSD Board Connector | SMAW200-07 | YEONHO |
| J2 | Connector | 12VDC/5VDC External Power Output Connector | SMAW200-6 | YEONHO |
| J4 | Jack | 24VDC Input Power Jack | Mini-Din 4P | - |
| J11 | Connector | DVI-D Input(TMDS) Connector | DVI-D24P | - |
| J23 | Connector | VGA Input Connector | 15P D-SUB | - |
| J14 | Connector | LCD Interface Connector(2Ch LVDS) | YDW200-30 | YEONHO |

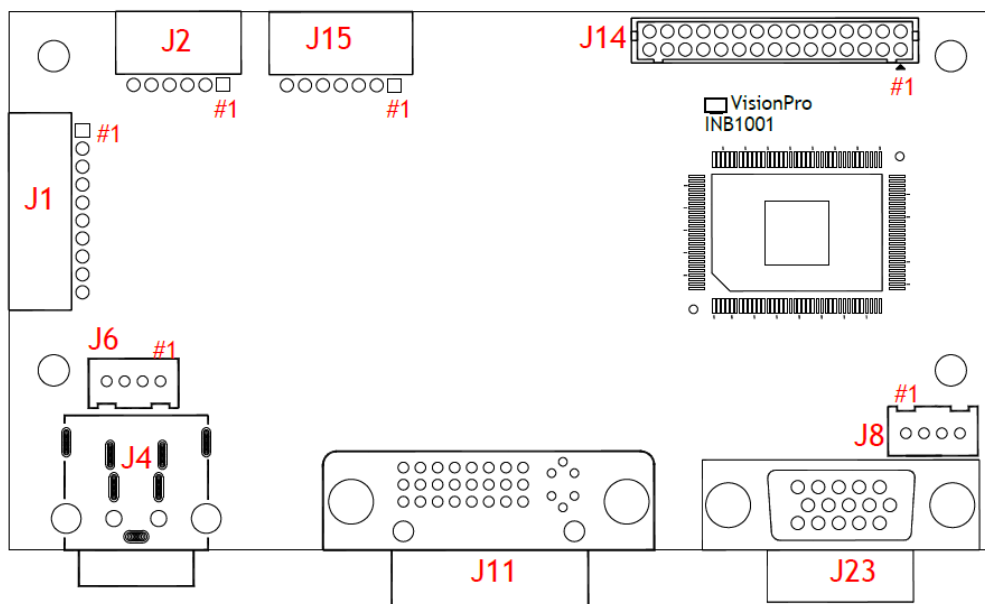

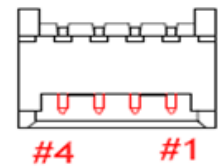

3.2 J6: 24VDC Power Input Connector

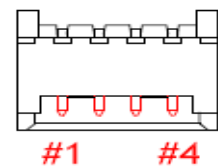
| Pin No. | Symbol | Description |
|---------|--------|-------------|
| 1 | VCC | 24VDC |
| 2 | VCC | 24VDC |
| 3 | GND | Ground |
| 4 | GND | Ground |

3.3 J8: Auto-Dimming / RS232 Connector

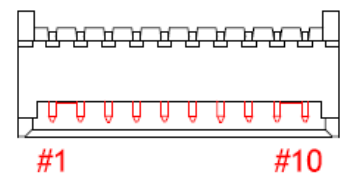
| Pin No. | Symbol | Description |
|---------|-----------------|--------------|
| 1 | RS232 RX | RS232 RX |
| 2 | RS232 TX | RS232 TX |
| 3 | Auto- Backlight | Auto-Dimming |
| 4 | GND | Ground |

3.4 J1: Backlight Inverter Connector

| Pin No. | Symbol | Description |
|----------|---------|---|
| 1 | DIM-ADJ | DIM-adjustment analog dimming control signal. * make sure inverter specification |
| 2 | ON/OFF | Inverter digital ON (3.3V)/OFF(0V) signal. |
| 3,4,5,6 | GND | Ground |
| 7,8,9,10 | VCC | 24VDC |

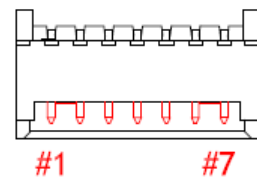
3.5 J15: OSD Board Connector

| Pin No. | Symbol | Description |
|---------|---------|----------------------------|
| 1 | VCC | +5V Power for IR sensor |
| 2 | IRQ | Infrared rays signal line. |
| 3 | LED1 | Green LED |
| 4 | LED2 | Red LED |
| 5 | GND | Ground |
| 6 | ADC-IN0 | Menu, Up |
| 7 | ADC-IN1 | Power, Down, Up |

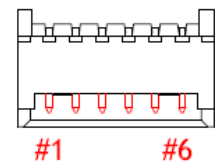
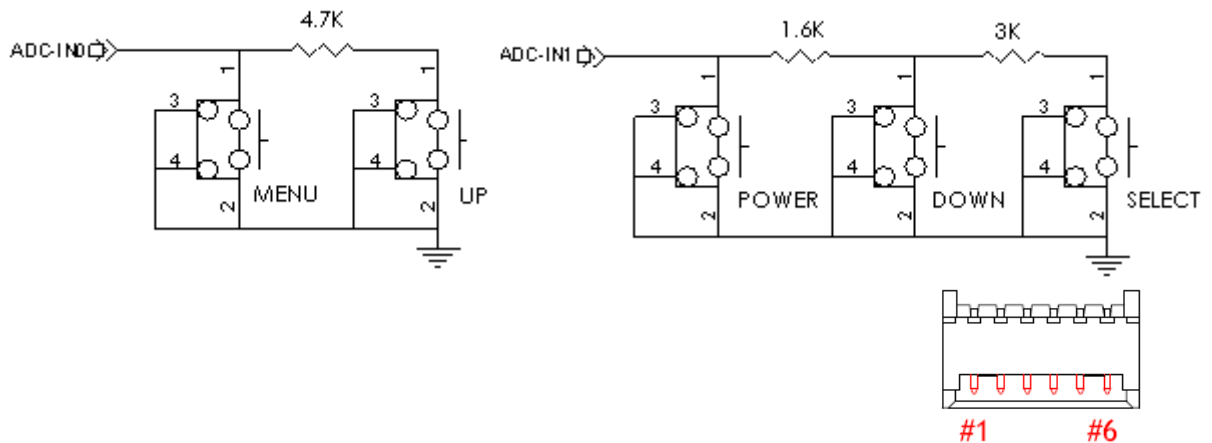
3.6 J2: 12VDC / 5VDC External Power Output Connector

| Pin No. | Symbol | Description |
|---------|--------|--------------|
| 1 | 12V | 12VDC Output |
| 2 | 12V | 12VDC Output |
| 3 | 5V | 5VDC Output |
| 4 | 5V | 5VDC Output |
| 5 | GND | Ground |
| 6 | GND | Ground |

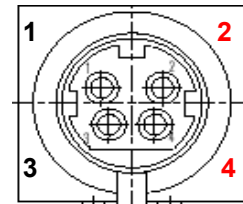
3.7 J4: 24VDC Power Input Jack

| Pin No. | Symbol | Description |
|---------|--------|-------------|
| 1,3 | GND | Ground |
| 2,4 | VCC | 24VDC |

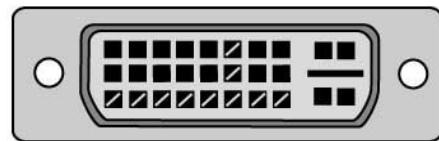
3.8 J11: DVI-D Input (TMDS) Connector

| Pin No. | Symbol | Description |
|---------|-------------------|--|
| 1 | TMDS DATA2- | TMDS DATA2 Differential Negative Signal |
| 2 | TMDS DATA2+ | TMDS DATA2 Differential Positive Signal |
| 3 | TMDS DATA2 Shield | Shield for TMDS Channel #2 |
| 4 | NC | No Connection |
| 5 | NC | No Connection |
| 6 | DDC Clock | The Data Line for the DDC Interface |
| 7 | DDC Data | The Clock Line for the DDC Interface |
| 8 | NC | No Connection |
| 9 | TMDS DATA1- | TMDS DATA1 Differential Negative Signal |
| 10 | TMDS DATA1+ | TMDS DATA1 Differential Positive Signal |
| 11 | TMDS DATA1 Shield | Shield for TMDS Channel #1 |
| 12 | NC | No Connection |
| 13 | NC | No Connection |
| 14 | +5V Power | +5 Volt signal for EDID (Un-powered Monitor) |
| 15 | GND(for +5V) | Ground for +5 Volt Power pin, Sync return |
| 16 | HPD | Identify the Presence of a Monitor |
| 17 | TMDS DATA0- | TMDS DATA0 Differential Negative Signal |
| 18 | TMDS DATA0+ | TMDS DATA0 Differential Positive Signal |
| 19 | TMDS DATA0 Shield | Shield for TMDS Channel #0 |
| 20 | NC | No Connection |
| 21 | NC | No Connection |
| 22 | TMDS CLOCK Shield | Shield for TMDS Clock Differential Pair |
| 23 | TMDS CLOCK+ | TMDS DATA0 Differential Positive Signal |
| 24 | TMDS CLOCK- | TMDS DATA0 Differential Negative Signal |

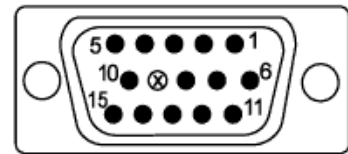
3.9 J23: VGA Input Connector

| Pin No. | Symbol | Description |
|---------|--------|--------------------|
| 1 | Red1 | Red Analog Input |
| 2 | Green1 | Green Analog Input |
| 3 | Blue1 | Blue Analog Input |
| 4 | GND | Ground |
| 5 | GND | Ground |
| 6 | GND | Ground |
| 7 | GND | Ground |
| 8 | GND | Ground |
| 9 | NC | No Connection |
| 10 | GND | Ground |
| 11 | GND | Ground |
| 12 | DSDA | DDC-SDA |
| 13 | HSYNC | Horizontal Sync |
| 14 | VSYNC | Vertical Sync |
| 15 | DSCL | Serial Clock Input |

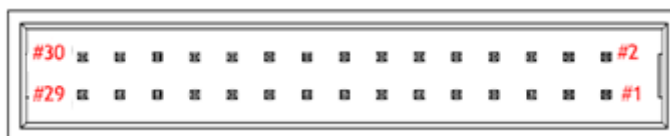
3.10 J14: LCD Interface Connector (8bit 2Ch LVDS)

| Pin No. | Symbol | Description |
|---------|----------|---|
| 1 | MOD_PWR | Panel Power (12V, 5V or 3.3V) |
| 2 | MOD_PWR | Panel Power (12V, 5V or 3.3V) |
| 3 | Option | High/Low for LCD Option |
| 4 | MOD_PWR | Panel Power (12V, 5V or 3.3V) |
| 5 | NC | No Connection |
| 6 | NC | No Connection |
| 7 | GND | Ground |
| 8 | GND | Ground |
| 9 | Y3N-EVEN | Negative(-) LVDS differential second 3 data |
| 10 | Y3P-EVEN | Positive(+) LVDS differential second 3 data |
| 11 | YCN-EVEN | Negative(-) LVDS differential second Clock |
| 12 | YCP-EVEN | Positive(+) LVDS differential second Clock |
| 13 | Y2N-EVEN | Negative(-) LVDS differential second 2 data |
| 14 | Y2P-EVEN | Positive(+) LVDS differential second 2 data |
| 15 | Y1N-EVEN | Negative(-) LVDS differential second 1 data |
| 16 | Y1P-EVEN | Positive(+) LVDS differential second 1 data |
| 17 | Y0N-EVEN | Negative(-) LVDS differential second 0 data |
| 18 | Y0P-EVEN | Positive(+) LVDS differential second 0 data |
| 19 | GND | Ground |
| 20 | GND | Ground |
| 21 | Y3N- ODD | Negative(-) LVDS differential first 3 data |
| 22 | Y3P-ODD | Positive(+) LVDS differential first 3 data |
| 23 | YCN- ODD | Negative(-) LVDS differential first Clock |
| 24 | YCP- ODD | Positive(+) LVDS differential first Clock |
| 25 | Y2N- ODD | Negative(-) LVDS differential first 2 data |
| 26 | Y2P- ODD | Positive(+) LVDS differential first 2 data |
| 27 | Y1N- ODD | Negative(-) LVDS differential first 1 data |
| 28 | Y1P- ODD | Positive(+) LVDS differential first 1 data |
| 29 | Y0N- ODD | Negative(-) LVDS differential first 0 data |
| 30 | Y0P- ODD | Positive(+) LVDS differential first 0 data |

4. Standard Display Modes

| ITEM | STD | Resolution | Pixel Frequency (MHz) | Vertical Frequency (Hz) | Horizontal Frequency (KHz) | Sync. Polarity (H/V) | Remark |
|------|------|------------|-----------------------|-------------------------|----------------------------|----------------------|--------|
| 1 | | 640*400 | 25.175 | 59.940 | 31.469 | | |
| 2 | | 640*480 | 25.175 | 59.940 | 31.469 | | VGA |
| 3 | VESA | 640*480 | 25.200 | 60.000 | 31.500 | | VGA |
| 4 | VESA | 640*480 | 31.500 | 72.809 | 37.861 | | VGA |
| 5 | VESA | 640*480 | 31.500 | 75.000 | 37.500 | | VGA |
| 6 | IBM | 720*400 | 28.322 | 70.087 | 31.469 | | |
| 7 | VESA | 800*600 | 36.000 | 56.250 | 35.156 | | SVGA |
| 8 | VESA | 800*600 | 40.000 | 60.317 | 37.879 | | SVGA |
| 9 | VESA | 800*600 | 50.000 | 72.188 | 48.077 | | SVGA |
| 10 | VESA | 800*600 | 49.500 | 75.000 | 46.875 | | SVGA |
| 11 | VESA | 1024*768 | 65.000 | 60.000 | 48.363 | | XGA |
| 12 | VESA | 1024*768 | 75.000 | 70.069 | 56.476 | | XGA |
| 13 | VESA | 1024*768 | 78.750 | 75.029 | 60.023 | | XGA |
| 14 | | 1152*864 | 94.500 | 70.012 | 63.851 | | |
| 15 | VESA | 1152*864 | 108.000 | 75.000 | 67.500 | | |
| 16 | | 1280*720 | 74.501 | 59.856 | 44.772 | | WXGA |
| 17 | | 1280*768 | 79.499 | 59.870 | 47.776 | | WXGA |
| 18 | VESA | 1280*960 | 108.000 | 60.000 | 60.000 | | WXGA |
| 19 | | 1360*768 | 72.000 | 59.960 | 47.368 | | WXGA |
| 20 | VESA | 1280*1024 | 108.000 | 60.020 | 63.981 | | SXGA |
| 21 | VESA | 1280*1024 | 135.000 | 75.025 | 79.976 | | |
| 22 | | 1680*1050 | 146.250 | 59.954 | 65.290 | | WSXGA+ |
| 23 | | 1600* 900 | 118.998 | 55.920 | 60.000 | | |
| 24 | | 1920*1080 | 138.500 | 59.934 | 66.587 | | |
| 25 | | 1920*1080 | 148.500 | 60.000 | 67.500 | | 1080P |
| 26 | | 1920*1080 | 148.352 | 59.940 | 67.433 | | 1080P |

5. LED Backlight Driver Board Specification

5.1 Electrical Specification

| Item | Symbol | Spec | Unit | Remarks |
|-----------------------|----------|------------|------|---------|
| Input Voltage 1 | Vin | 23.0 ~25.0 | V | |
| Input Voltage 2 | ON / OFF | 0 ~ 5.0 | V | |
| Operating Temperature | TOP | 0 ~ 50 | °C | |
| Storage Temperature | Tstg | -20 ~60 | °C | |
| Relative Humidity | RH | 80 | % | |

5.2 Control Signal

| Item | Symbol | Status | Action | Remarks |
|---------|--------|--------|---------|---------|
| CN1 #12 | ON/OFF | HIGH | LED-ON | 5.0V |
| | | LOW | LED-OFF | 0V |

5.3 Output Characteristics

| NO | Item | Symbol | Min | Type | Max | Unit |
|----|--------------------|---|-----------|------|----------|------|
| 1 | Input Voltage | Vin | 20.8 | 24 | 26 | V |
| 2 | Input Current | Iin | | 0.7 | 2 | A |
| 3 | Input Power | Pin | | 36 | 52 | W |
| 4 | Brightness Voltage | Vadj | 0(bright) | --- | 5 (dark) | V |
| 5 | Control Voltage | Enable Von=1.5---5.0V Disable Voff=0---0.5V | | | | |

| Item | Symbol | Test Conditions | Min | Type | Max | Unit |
|----------------------------|--------|--|-----|------|-------|------|
| Output Current (per group) | Iout | Vin=24.0V; Vout=57V; Ta=28°C | | 540 | 750 | mA |
| Output Voltage | Vout | Vin=24.0V; Ta=28°C | 30 | 66 | 85 | V |
| Efficiency | η | Vin=24.0V; Vout=57V; | | 92.5 | | % |
| Output total group | Ggp | | | 1 | | |
| The Total Output Current | R | According to the backlight parameters to adjust output current | | 540 | 750 | MA |
| output power | W out | Vin=24.0V; Vout=30-85V; | | 36 | 63.75 | W |

5.4 Interface

5.4.1 CN1 Connector: 20010WR-14 (YeonHo) or EQ

| Pin | Symbol | Remarks |
|------------|--------|------------------------------------|
| 1,2,3,4,5 | Vin | Input Voltage 24VDC |
| 6,7,8,9,10 | GND | GND |
| 12 | On/Off | Backlight On/Off (5V:On, 0V : Off) |
| 13 | PDIM | External PWM |
| 14,11 | NC | No Connection |

6. Board Dimensions

6.1 AD Board (INB1001) Dimension (110mm x 60mm x 14.5mm)

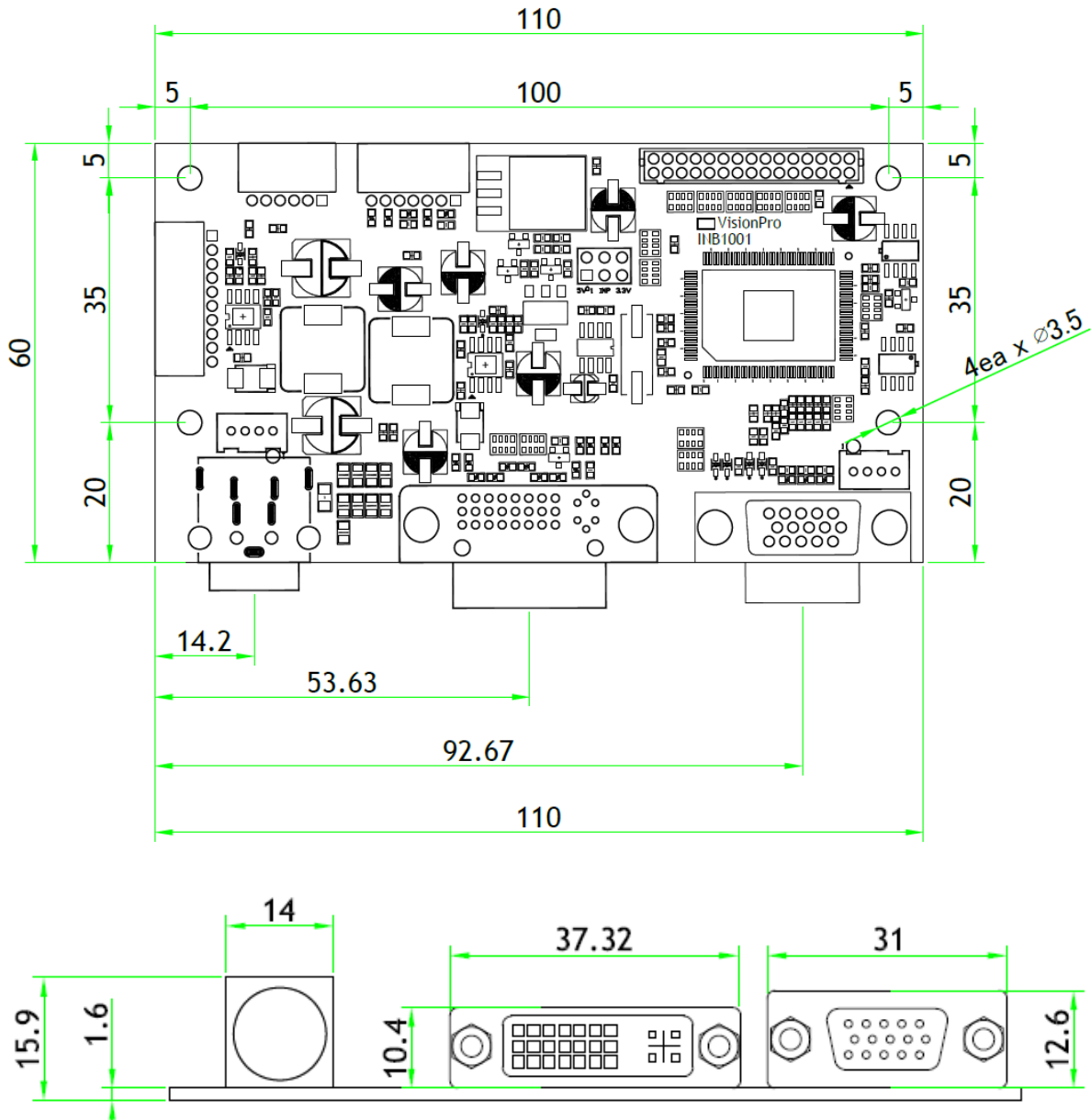

6.2 OSD Board (K002) Dimension (115mm x 20mm x 8.7mm)

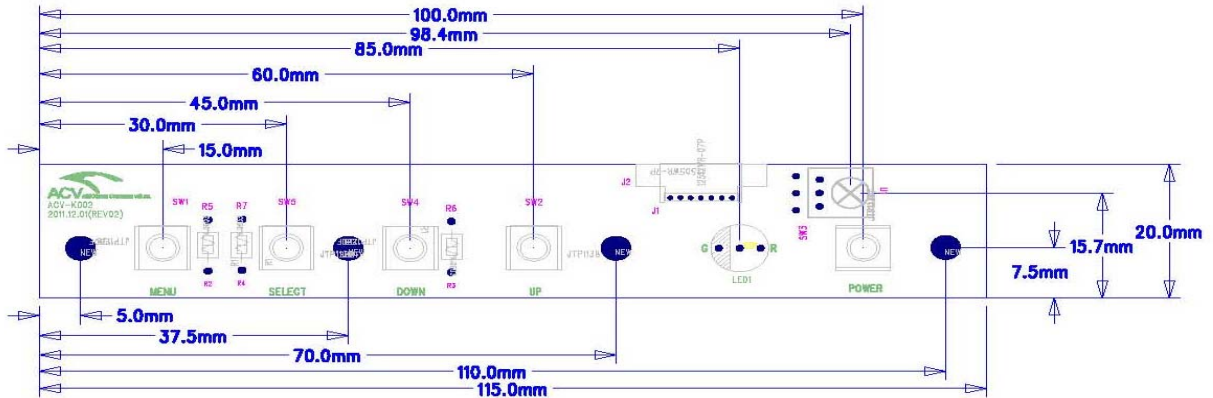

7. LED Lighting Control Interface Specification

7.1 Connector Spec

- Connector: Molex 43020-0600

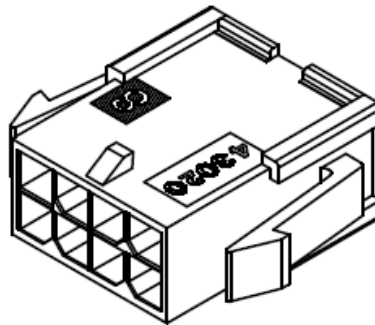

- Matching Housing: Molex 43025-0600

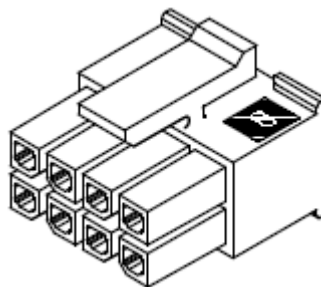

7.2 External LED Connector Pin Map

7.2.1 With IC (Dual-Line) LED Bar Board

LED Lighting Control Port Pin Map (w/ IC)
 #1 : 5V, #2 : CTL, #3 : GND
 #4 : 5V, #5 : NC, #6 : GND

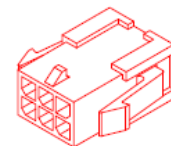
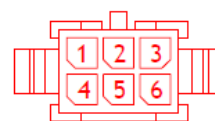

Molex 43020-0600

| Pin No | Symbol | Remark |
|--------|--------|--------------------------|
| 1 | 5V | DC 5V (Master) |
| 2 | CTL | With IC LED Control Line |
| 3 | GND | GND |
| 4 | 5V | DC 5V (Slave) |
| 5 | NC | Non Connection |
| 6 | GND | GND |

7.3 LED (BT5050B) Spec

7.3.1 LED (BT5050B) Pin Configuration

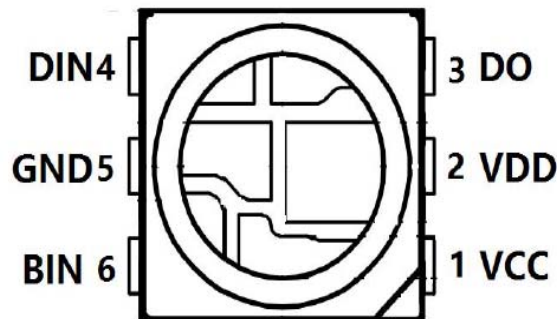

PIN Function

| NO. | Symbol | PIN | Function description |
|-----|--------|-----|------------------------------------|
| 1 | VCC | VCC | IC POWER SUPPLY |
| 2 | VDD | VDD | LED POWER SUPPLY, connect to “+5V” |
| 3 | DO | DO | Control data signal output |
| 4 | DIN | DIN | Control data signal input |
| 5 | GND | GND | Data & Power Grounding |
| 6 | BIN | BIN | Backup Control data signal input |

7.3., LED (BT5050B) Circuit

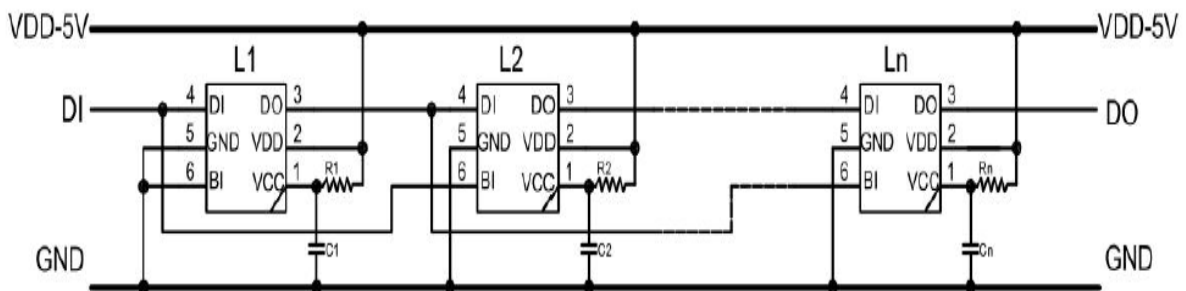

8. Packing Information

| Item | Q'ty | Dimension (W x H x D) | Weight(Kg) | Remark |
|----------------|------|----------------------------|------------|--------|
| Closed Frame | 1Pcs | 774.0mm x 482.0mm x 65.0mm | TBD | |
| Box Packing | | | TBD | |
| Pallet Size | | | TBD | |
| Pallet Packing | | | TBD | |

9. Mechanical Structure

| Rev | AMEND | DATE | CHECK | APPR. |
|-----|-------|------------|---------|----------|
| P1 | Proto | 2019.09.02 | H.I.Woo | H.Y.Sohn |
| P2 | | | | |
| P3 | | | | |

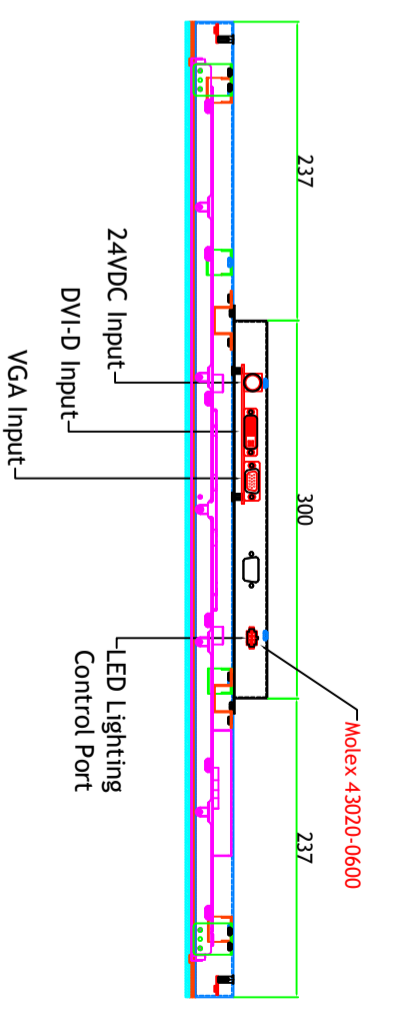
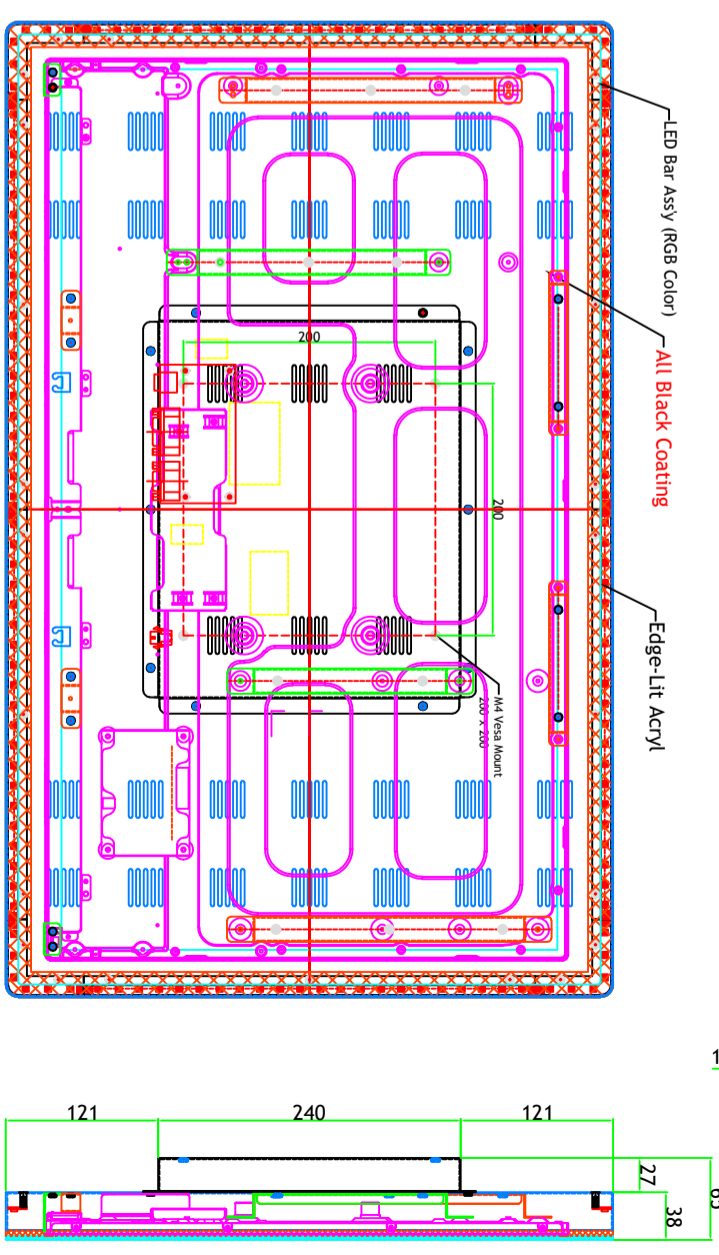
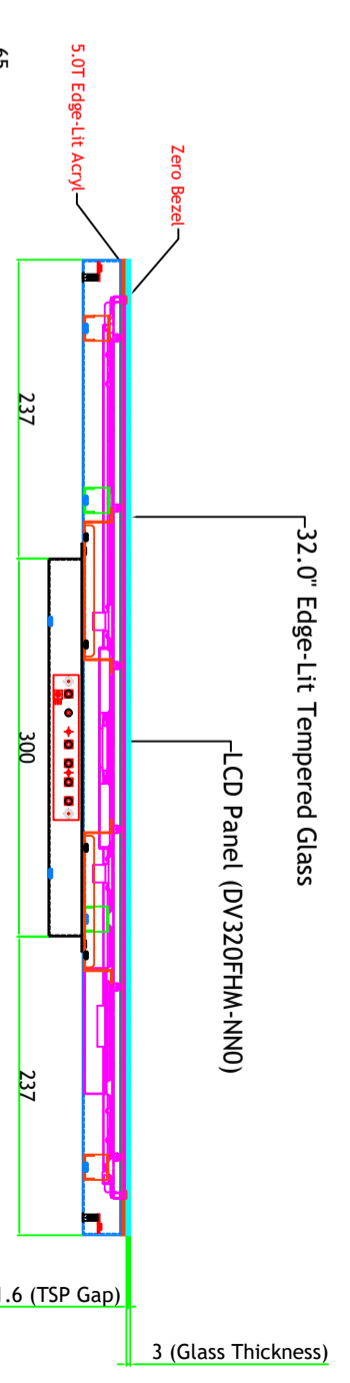
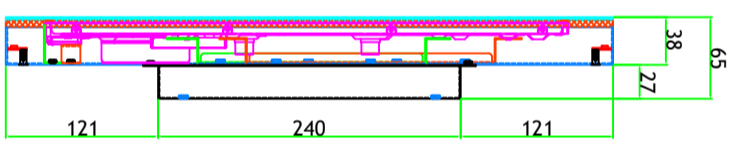
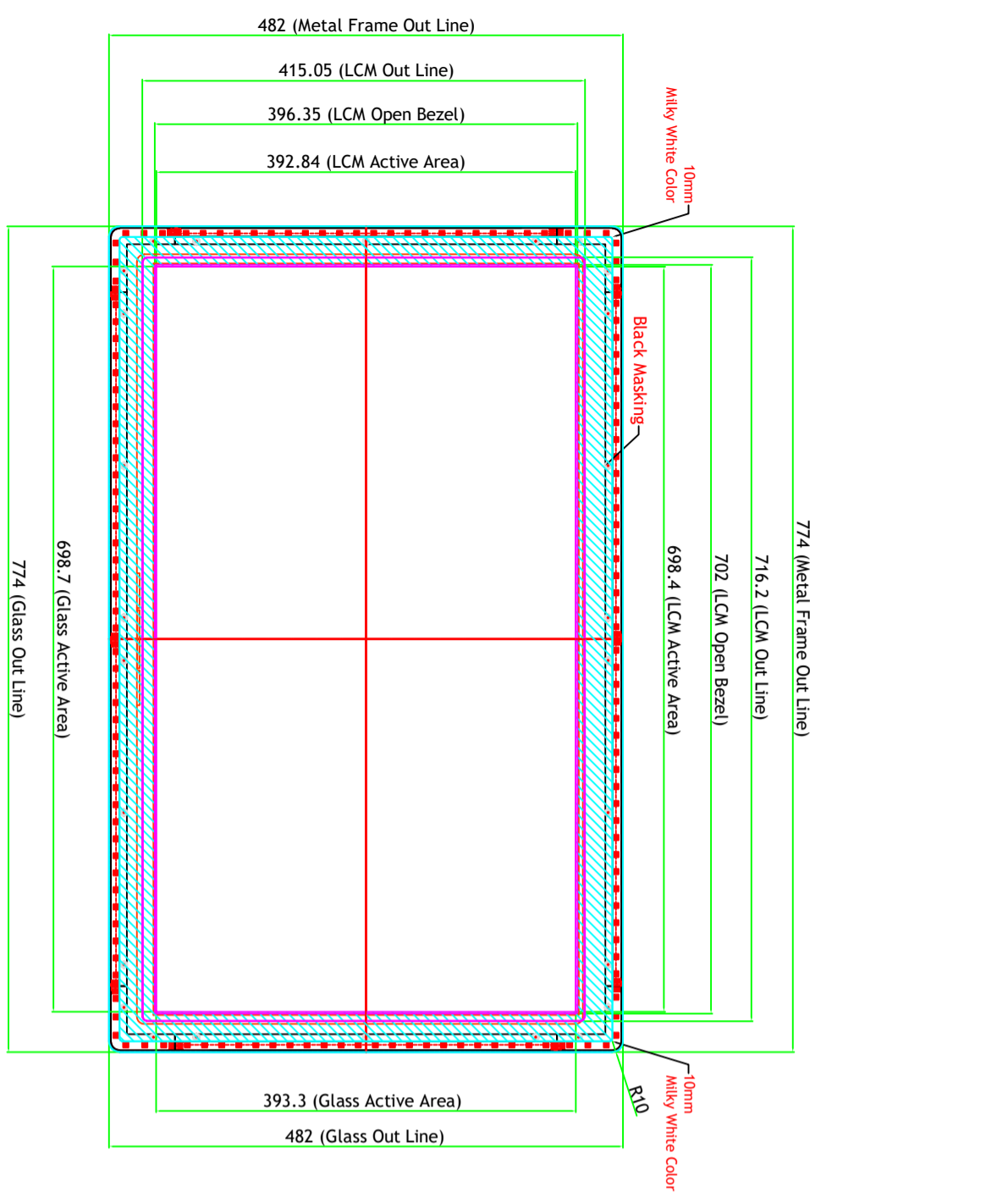

LED Lighting Control Port Pin Map (w/ IC)

#1 : 5V, #2 : CTL, #3 : GND
 #4 : 5V, #5 : NC, #6 : GND

Molex 43020-0600

Main Frame GI = 1.2T Black Coating
 Rear Cover GI = 1.0T Black Coating

| | | | | | | |
|----------|---------|----------|-------------------|--------------|-------|------------|
| SUZOHAPP | | MODEL NO | 150DLG3206 | | VIEW | UNIT : mm |
| | | NAME | 32" Closed Frame | | Q'ty | |
| DRAWN | CHECKED | APPROVED | DWG. NO | 4M3203042-00 | SCALE | 1 / 1 |
| H.I.Woo | | H.Y.Sohn | MATERIAL / FINISH | EGI T=1.2 | DATE | 2019.09.02 |

| Rev | AMEND | DATE | CHECK | APPR. |
|-----|-------|------------|---------|----------|
| P1 | Proto | 2019.09.02 | H.I.Woo | H.Y.Sohn |
| P2 | | | | |
| P3 | | | | |

Front View

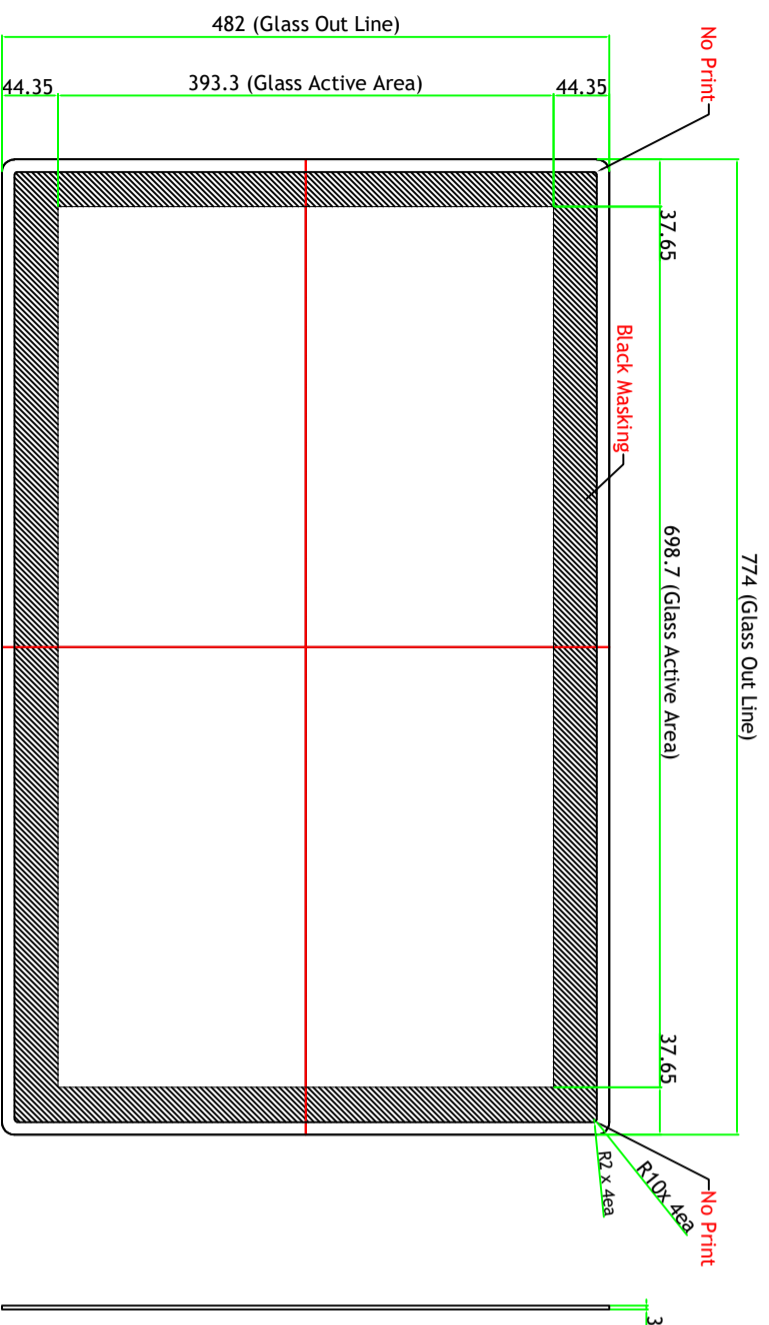

Rear View

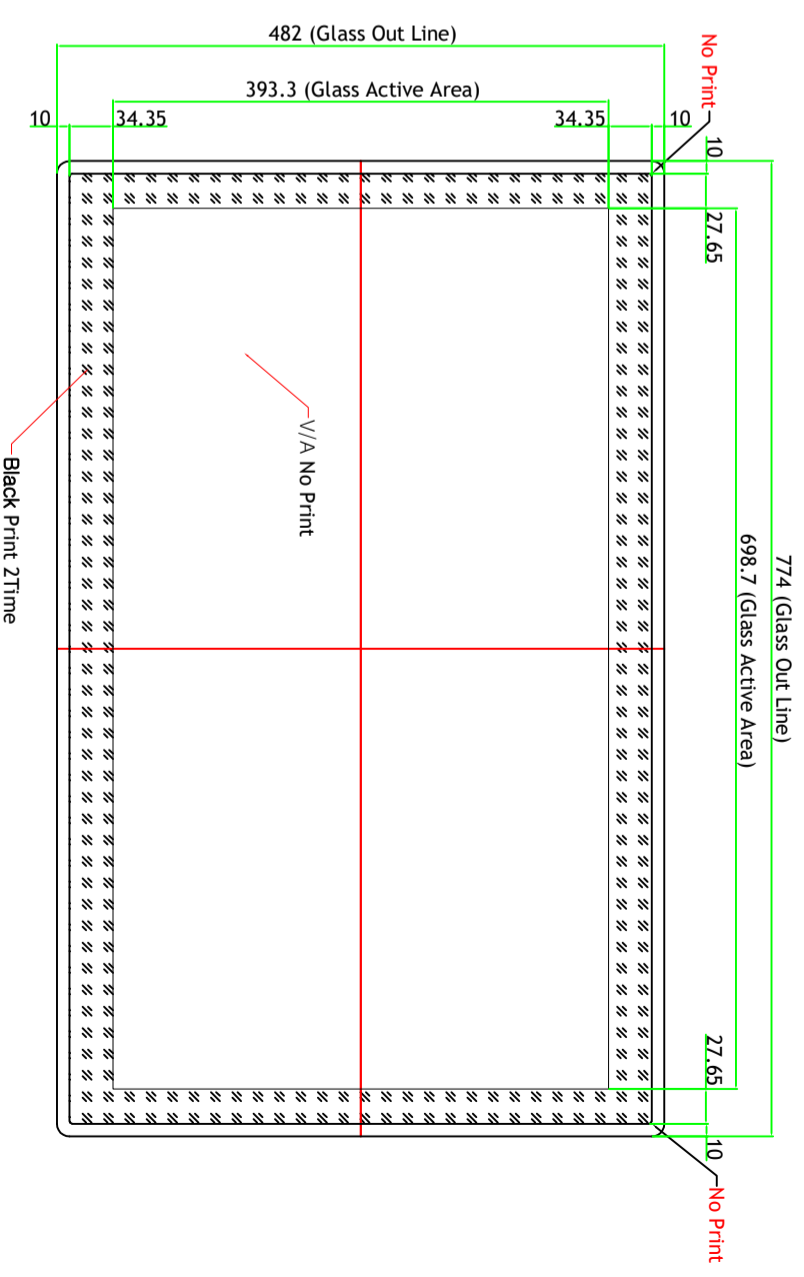

- Black Masking : 2time

PGLSHT3203002 32.0" Edge-Lit Model Glass Drawing

| | | | | | | | | | | |
|---------|---------|----------|-------------------|--------------|--------|-------|------------|--------|----|--|
| | | MODEL NO | 150DLG3206 | | VIEW : | | | UNIT : | mm | |
| | | NAME | 32" Closed Frame | | Qty | 1 | | REV. | P1 | |
| DRAWN | CHECKED | APPROVED | DWG. NO | 4M3203042-00 | | SCALE | 1 / 1 | | | |
| H.I.Woo | | H.Y.Sohn | MATERIAL / FINISH | EGI T=1.2 | | DATE | 2019.09.02 | | | |

| ASSEMBLY ITEM NUMBER | PART CHARACTERISTICS | | MATERIAL |
|----------------------|----------------------|--------------------|----------|
| | NUMBER OF POSITION | PANEL MOUNT OPTION | |
| | 43020-0200 | 02 | |
| 43020-0201 | 02 | NO | |
| 43020-0400 | 04 | YES | |
| 43020-0401 | 04 | NO | |
| 43020-0600 | 06 | YES | |
| 43020-0601 | 06 | NO | |
| 43020-0800 | 08 | YES | |
| 43020-0801 | 08 | NO | |
| 43020-1000 | 10 | YES | |
| 43020-1001 | 10 | NO | |
| 43020-1200 | 12 | YES | |
| 43020-1201 | 12 | NO | |
| 43020-1400 | 14 | YES | |
| 43020-1401 | 14 | NO | |
| 43020-1600 | 16 | YES | |
| 43020-1601 | 16 | NO | |
| 43020-1800 | 18 | YES | |
| 43020-1801 | 18 | NO | |
| 43020-2000 | 20 | YES | |
| 43020-2001 | 20 | NO | |
| 43020-2200 | 22 | YES | |
| 43020-2201 | 22 | NO | |
| 43020-2400 | 24 | YES | |
| 43020-2401 | 24 | NO | |

| CKT. NO. | DIM. 'A' | DIM. 'B' | DIM. 'C' | DIM. 'D' |
|----------|---------------|---------------|---------------|---------------|
| 2 | .152/(3.86) | N/A | .166/(4.21) | .311/(7.90) |
| 4 | .270/(6.85) | .118/(3.00) | .284/(7.21) | .429/(10.90) |
| 6 | .388/(9.85) | .236/(6.00) | .402/(10.21) | .547/(13.89) |
| 8 | .506/(12.85) | .354/(9.00) | .520/(13.21) | .665/(16.89) |
| 10 | .624/(15.85) | .472/(12.00) | .638/(16.21) | .783/(19.89) |
| 12 | .742/(18.85) | .591/(15.00) | .756/(19.21) | .901/(22.89) |
| 14 | .860/(21.85) | .709/(18.00) | .874/(22.20) | 1.019/(25.88) |
| 16 | .978/(24.85) | .827/(21.00) | .992/(25.20) | 1.137/(28.88) |
| 18 | 1.096/(27.85) | .945/(24.00) | 1.110/(28.20) | 1.255/(31.88) |
| 20 | 1.215/(30.85) | 1.063/(27.00) | 1.229/(31.22) | 1.373/(34.87) |
| 22 | 1.333/(33.85) | 1.181/(30.00) | 1.347/(34.22) | 1.491/(37.87) |
| 24 | 1.451/(36.85) | 1.299/(33.00) | 1.465/(37.22) | 1.609/(40.87) |

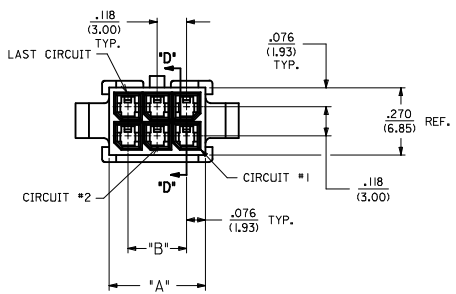

- NOTES:
- HOUSING MATERIAL:
 - 'A' - UNFILLED POLYESTER, RATED U.L. 94V-0, COLOR IS BLACK.
 - 'B' - UNFILLED NYLON, RATED U.L. 94V-0, HALOGEN-FREE, COLOR IS BLACK.
 - FINISH: N/A
 - PRODUCT SPECIFICATION: PS-43045
 - PACKAGING SPECIFICATION: PK-43020-001
 - THIS HOUSING MATES WITH MICRO-FIT RECEPTACLE #43025-****
 - THIS HOUSING TO BE USED WITH MOLEX MALE TERMINAL #43031-****
 - DESIGNED FOR .055(1.4) MINIMUM TO A .100(2.54) MAXIMUM THICK PANEL OR PRINTED CIRCUIT BOARD.
 - SEE SECTION 'D'-D' FOR TERMINAL ORIENTATION IN HOUSING.
 - PANEL MOUNT FEATURES MUST LOCK ON SIDE OPPOSITE PUNCH SIDE FOR OPTIMUM RETENTION.
 - PART CONFORMS TO CLASS 'B' REQUIREMENTS OF COSMETIC SPECIFICATION PS-45499-002. SOME HOUSINGS MAY HAVE A SMALL GATE BLEMISH NEAR THE GATE LOCATION THAT DOES NOT AFFECT FUNCTIONALITY.

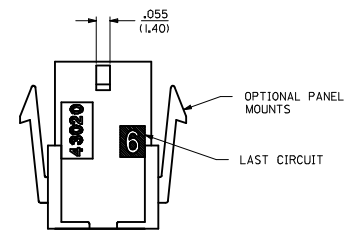
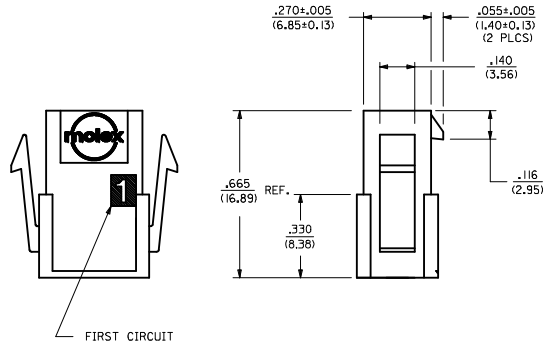
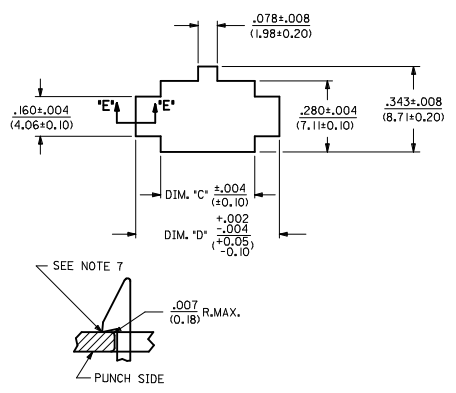

SEE NOTE 7

SECTION 'E'-E'
NO SCALE

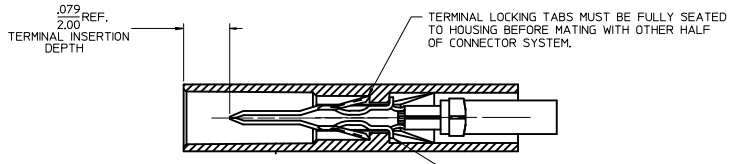

SECTION 'B'-B'

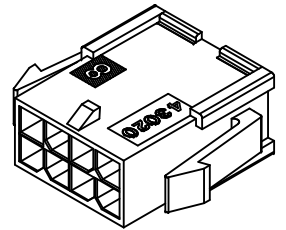

PLUG WITH OPTIONAL PANEL MOUNTS ISO VIEW (8 CIRCUIT SHOWN)

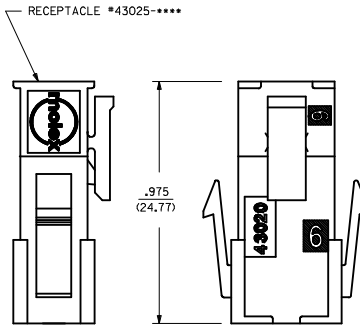

MATED MICRO-FIT CONNECTOR

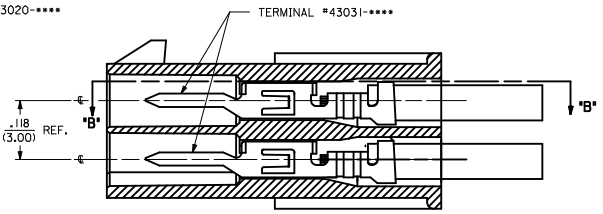

SECTION 'D'-D'
WITH TERMINAL SCALE 8X

| | | | | | | | | | | |
|--|---|--|---------|---|-----------------------------------|---------------------------------------|---|---------------------------|--------------------------------|---------------------|
| UPDATE PUNCHED HOLE IEC NO. UCF2017-0525 DRAWN/OUTLES 2016/09/13 CHKD/SSOUSEK 2016/09/13 APPR/FSM TH 2016/10/07 | QUALITY SYMBOLS ∇=0 ∇=0 ∇=0 | GENERAL TOLERANCES (UNLESS SPECIFIED) | | DIMENSION STYLE IN/MM | SCALE METRIC | DESIGN UNITS METRIC | THIRD ANGLE PROJECTION | | | |
| | | 4 PLACES ± .010 3 PLACES ± .010 2 PLACES ± 0.25 ± .014 1 PLACE ± 0.35 ± .014 0 PLACE ± .010 ± .014 | mm INCH | DRAWN BY DATE AFG 1993/01/07 | CHECKED BY DATE BAP 1993/01/07 | APPROVED BY DATE FSMITH 2016/10/07 | TITLE MICRO-FIT(3,0) 2 THRU 24 CIRCUIT PLUG WITH OPTIONAL PANEL MOUNTS | MATERIAL NO. SEE CHART | DOCUMENT NO. SDA-43020-**** | SHEET NO. 1 OF 1 |
| | | ANGULAR ±1/2° DRAFT WHERE APPLICABLE MUST REMAIN WITHIN DIMENSIONS | SIZE D | THIS DRAWING CONTAINS INFORMATION THAT IS PROPRIETARY TO MOLEX INCORPORATED AND SHOULD NOT BE USED WITHOUT WRITTEN PERMISSION | | | | | | |
| | | | | | | | | | | |

| PART CHARACTERISTICS | | |
|----------------------|----------------------|----------|
| NUMBER OF POSITION | ASSEMBLY ITEM NUMBER | MATERIAL |
| 02 | 43025-0200 | 'B' |
| 04 | 43025-0400 | |
| 06 | 43025-0600 | |
| 08 | 43025-0800 | |
| 10 | 43025-1000 | 'A' |
| 12 | 43025-1200 | |
| 14 | 43025-1400 | 'B' |
| 16 | 43025-1600 | 'A' |
| 18 | 43025-1800 | 'B' |
| 20 | 43025-2000 | |
| 22 | 43025-2200 | 'A' |
| 24 | 43025-2400 | |

| CKT. NO. | DIM. "A" +0.14 -0.10 +0.35 -0.25 | DIM. "B" |
|----------|--|---------------|
| 2 | .152/(3.86) | N/A |
| 4 | .270/(6.85) | .118/(3.00) |
| 6 | .388/(9.85) | .236/(6.00) |
| 8 | .506/(12.85) | .354/(9.00) |
| 10 | .624/(15.85) | .472/(12.00) |
| 12 | .742/(18.85) | .591/(15.00) |
| 14 | .860/(21.85) | .709/(18.00) |
| 16 | .978/(24.85) | .827/(21.00) |
| 18 | 1.096/(27.85) | .945/(24.00) |
| 20 | 1.215/(30.85) | 1.063/(27.00) |
| 22 | 1.333/(33.85) | 1.181/(30.00) |
| 24 | 1.451/(36.85) | 1.299/(33.00) |

- NOTES:**
- HOUSING MATERIAL:
'A' - UNFILLED POLYESTER, RATED UL, 94V-0, COLOR IS BLACK.
'B' - UNFILLED NYLON, RATED UL, 94V-0, HALOGEN-FREE, COLOR IS BLACK.
 - FINISH: N/A
 - PRODUCT SPECIFICATION: PS-43045
 - PACKAGING SPECIFICATION: PK-43025-001
 - THIS RECEPTACLE MATES WITH 43020, 43045.
 - THIS RECEPTACLE TO BE USED WITH MOLEX FEMALE TERMINAL SERIES 43030 OR 46235. SEE SECTION 'A'-A' FOR TERMINAL ORIENTATION IN HOUSING.
 - FOR OVERMOLDING PARAMETERS SEE ENGINEERING SPECIFICATION #SDS-43025-1000.
 - TOP PULL TABS ARE NOT AVAILABLE ON 2 AND 4 CIRCUIT PARTS.
 - MOLEX RECOMMENDS THE USE OF MICRO-FIT TEST PLUG, SERIES NO. 44242-***** WHENEVER TESTING IS PERFORMED. TEST PLUGS MUST NOT BE USED FOR MAKE OR BREAK UNDER LOAD. MOLEX DOES NOT RECOMMEND USING STANDARD MATING COMPONENTS FOR HARNESS TESTING PURPOSES.
 - SOME HOUSINGS MAY HAVE A SMALL GATE BLEMISH NEAR THE GATE THAT DOES NOT AFFECT FUNCTIONALITY.
 - HOUSINGS HAVE EITHER AN IDENTIFIER RIB OR ENGRAVED '1' SYMBOL TO INDICATE CIRCUIT #1. IDENTIFIER TYPE IS TOOL DEPENDENT AND NOT SELECTABLE.
 - DIMENSION 'A' MEASURED AT DATUM \square -A-
 - THIS PART CONFORMS TO CLASS 'B' REQUIREMENTS OF COSMETIC SPECIFICATION PS-45499-002.

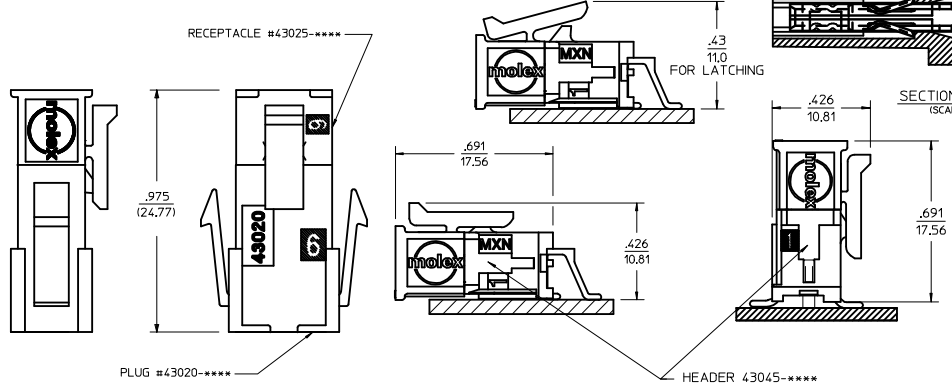
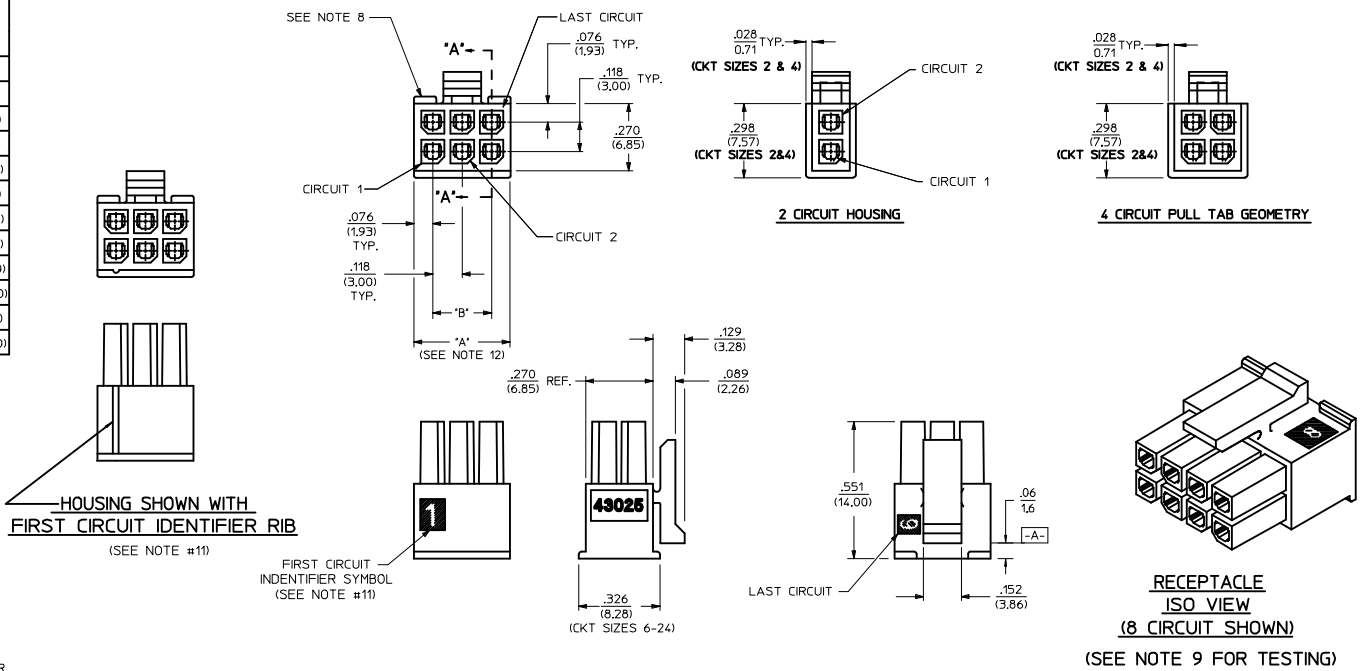

MATED MICRO-FIT CONNECTOR

| ADD MATED VIEW IEC NO: UCP2016-4677 DRAWN BY: DRYNAPPELDORN CHECKED BY: CHYKJDOX APPROVED BY: APPREHSMITH DATE: 2016/06/03 DATE: 2016/06/03 DATE: 2016/06/09 | QUALITY SYMBOLS $\nabla=0$ $\nabla=0$ $\nabla=0$ | GENERAL TOLERANCES (UNLESS SPECIFIED): <table border="1"> <tr> <th></th> <th>mm</th> <th>INCH</th> </tr> <tr> <td>4 PLACES</td> <td>±.010</td> <td>±.010</td> </tr> <tr> <td>3 PLACES</td> <td>±.014</td> <td>±.014</td> </tr> <tr> <td>2 PLACES</td> <td>±.025</td> <td>±.010</td> </tr> <tr> <td>1 PLACE</td> <td>±.035</td> <td>±.014</td> </tr> <tr> <td>0 PLACE</td> <td>±.050</td> <td>±.020</td> </tr> </table> | | mm | INCH | 4 PLACES | ±.010 | ±.010 | 3 PLACES | ±.014 | ±.014 | 2 PLACES | ±.025 | ±.010 | 1 PLACE | ±.035 | ±.014 | 0 PLACE | ±.050 | ±.020 | DIMENSION STYLE IN/MM DRAWN BY: DATE: TITLE: A. F. G. 1993/01/14 CHECKED BY: DATE: B. A. P. 1993/01/14 APPROVED BY: DATE: FSMITH 2016/05/02 | SCALE: DESIGN UNITS: METRIC THIRD ANGLE PROJECTION |
|--|---|---|---|----|------|----------|-------|-------|----------|-------|-------|----------|-------|-------|---------|-------|-------|---------|-------|-------|---|--|
| | | mm | INCH | | | | | | | | | | | | | | | | | | | |
| | 4 PLACES | ±.010 | ±.010 | | | | | | | | | | | | | | | | | | | |
| | 3 PLACES | ±.014 | ±.014 | | | | | | | | | | | | | | | | | | | |
| 2 PLACES | ±.025 | ±.010 | | | | | | | | | | | | | | | | | | | | |
| 1 PLACE | ±.035 | ±.014 | | | | | | | | | | | | | | | | | | | | |
| 0 PLACE | ±.050 | ±.020 | | | | | | | | | | | | | | | | | | | | |
| MATERIAL NO: SEE CHART | DOCUMENT NO: SDA-43025-**** | SHEET NO: 1 OF 1 | micro-fit (3.0) 2 THRU 24 CIRCUIT RECEPTACLE molex | | | | | | | | | | | | | | | | | | | |
| SIZE: D THIS DRAWING CONTAINS INFORMATION THAT IS PROPRIETARY TO MOLEX INCORPORATED AND SHOULD NOT BE USED WITHOUT WRITTEN PERMISSION | | | | | | | | | | | | | | | | | | | | | | |