

Rev	AMEND	DATE	CHECK	APPR.
P1	Proto	2019.09.02	H.I.Woo	H.Y.Sohn
P2				
P3				

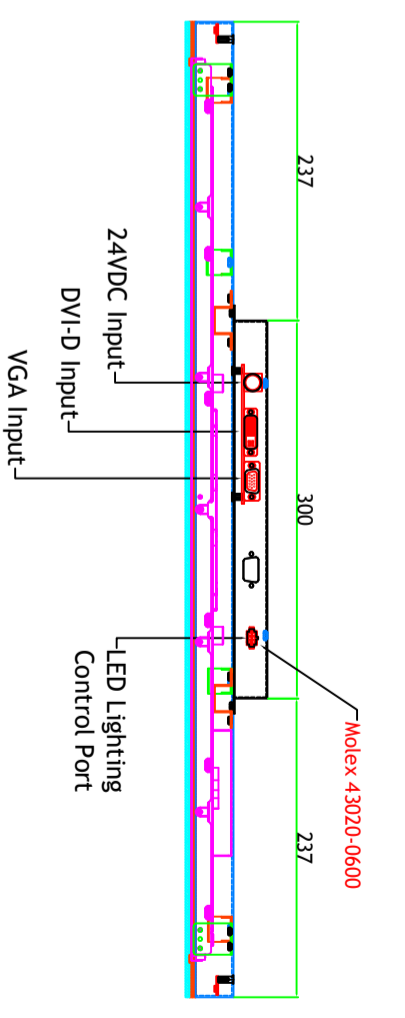
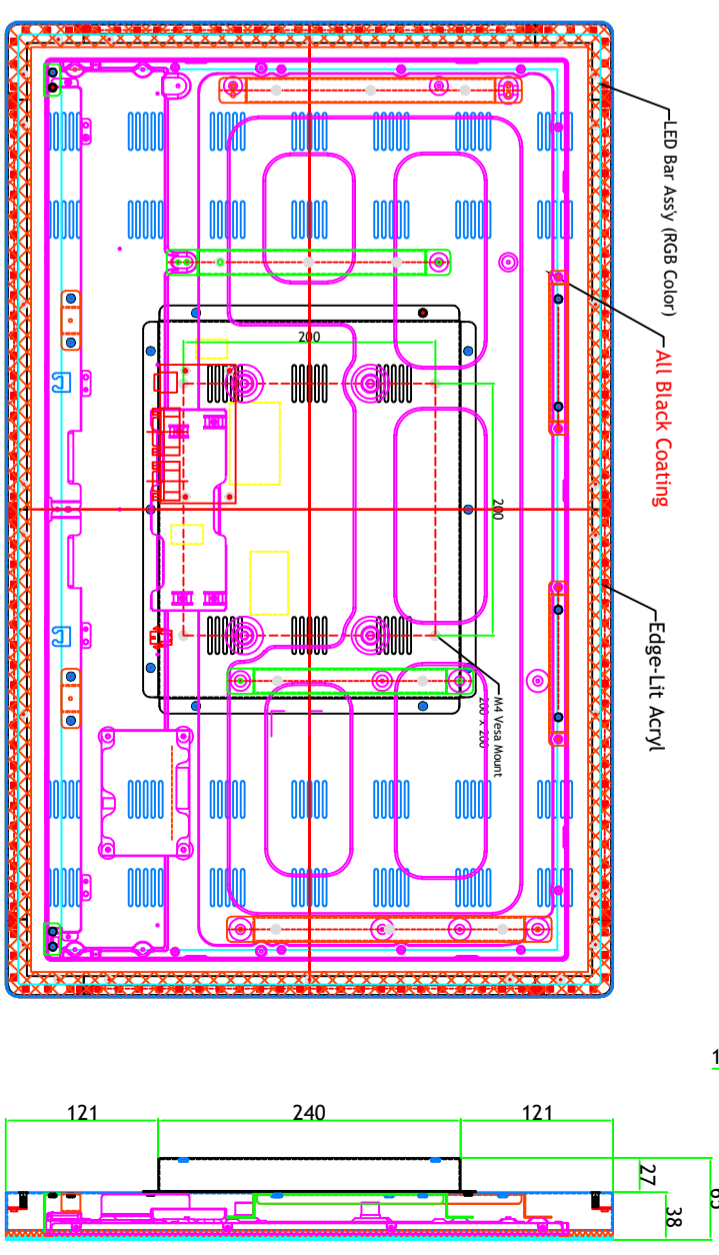
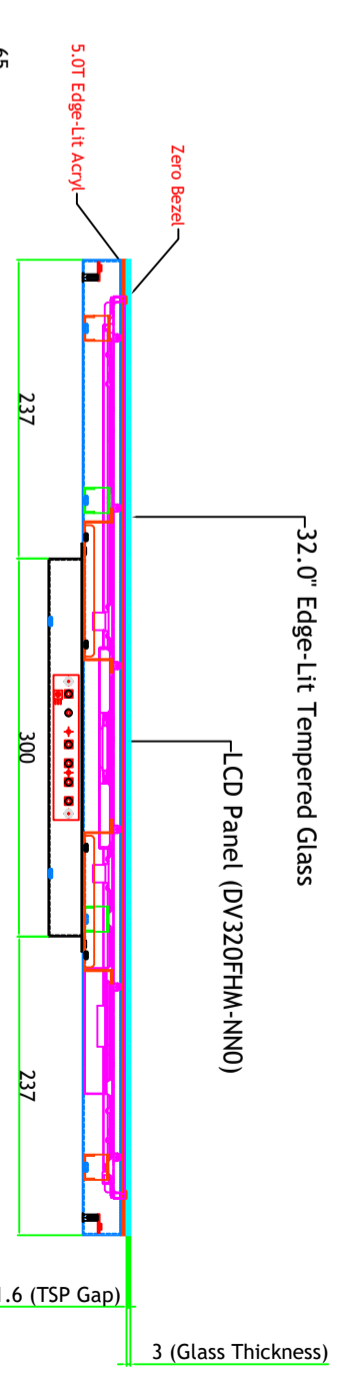
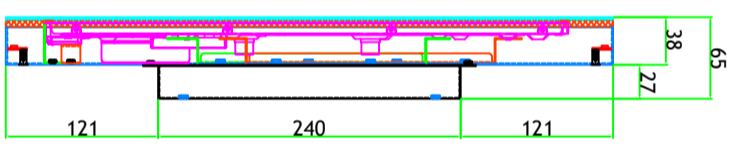
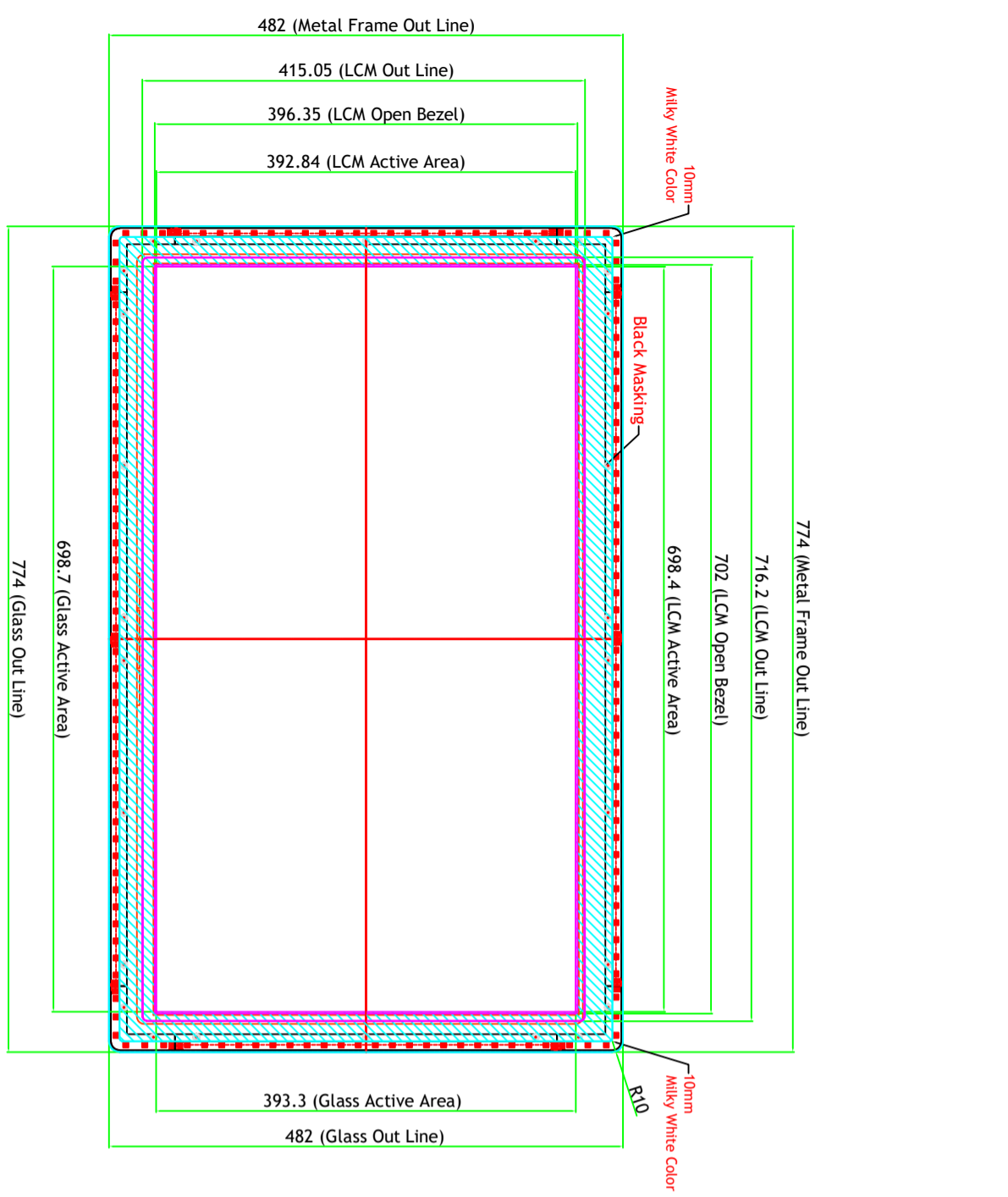

**LED Lighting Control Port Pin Map (w/ IC)**

#1 : 5V, #2 : CTL, #3 : GND  
 #4 : 5V, #5 : NC, #6 : GND

Molex 43020-0600

SUZOHAPP		MODEL NO	150DLG3206		VIEW	UNIT : mm
NAME	32" Closed Frame		Q'ty	1	REV.	P1
DRAWN	CHECKED	APPROVED	DWG. NO	4M3203042-00	SCALE	1 / 1
H.I.Woo		H.Y.Sohn	MATERIAL / FINISH	EGI T=1.2	DATE	2019.09.02

Main Frame GI = 1.2T Black Coating  
 Rear Cover GI = 1.0T Black Coating

Rev	AMEND	DATE	CHECK	APPR.
P1	Proto	2019.09.02	H.I.Woo	H.Y.Sohn
P2				
P3				

### Front View

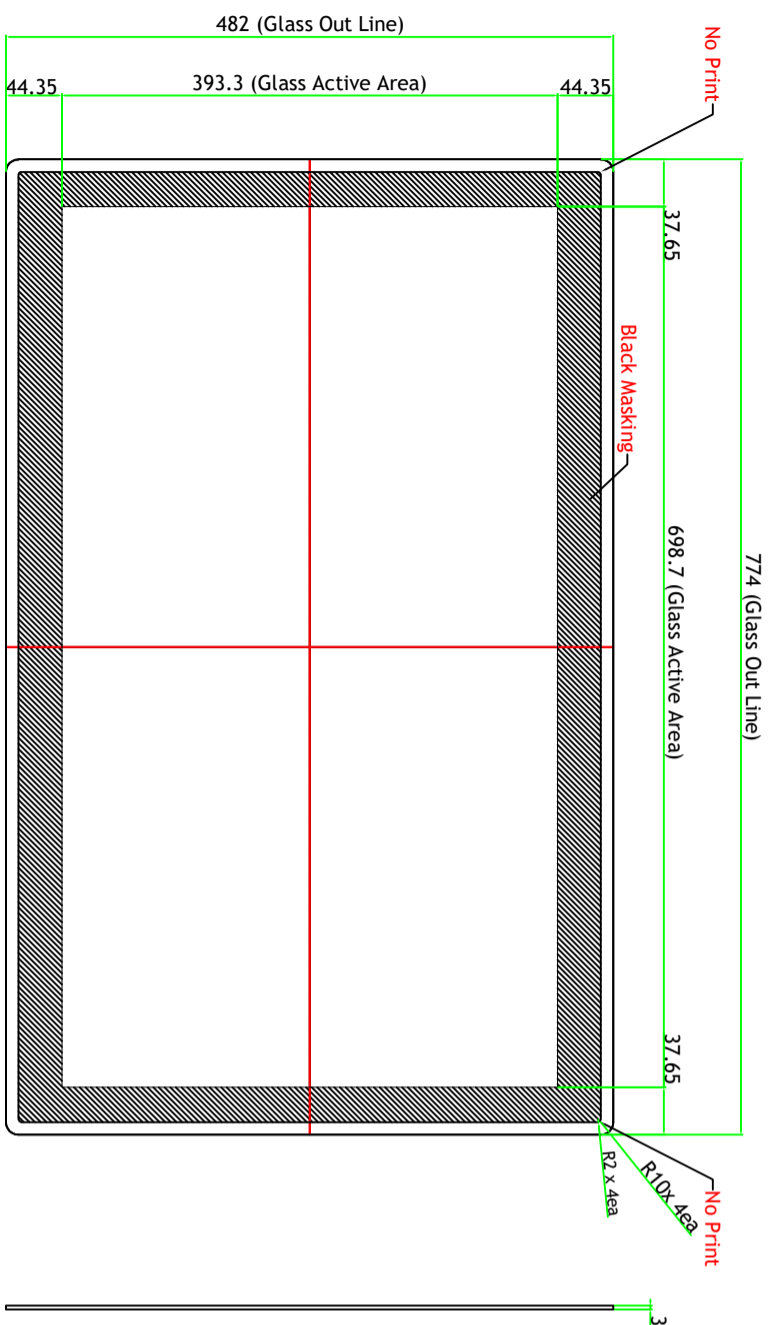

### Rear View

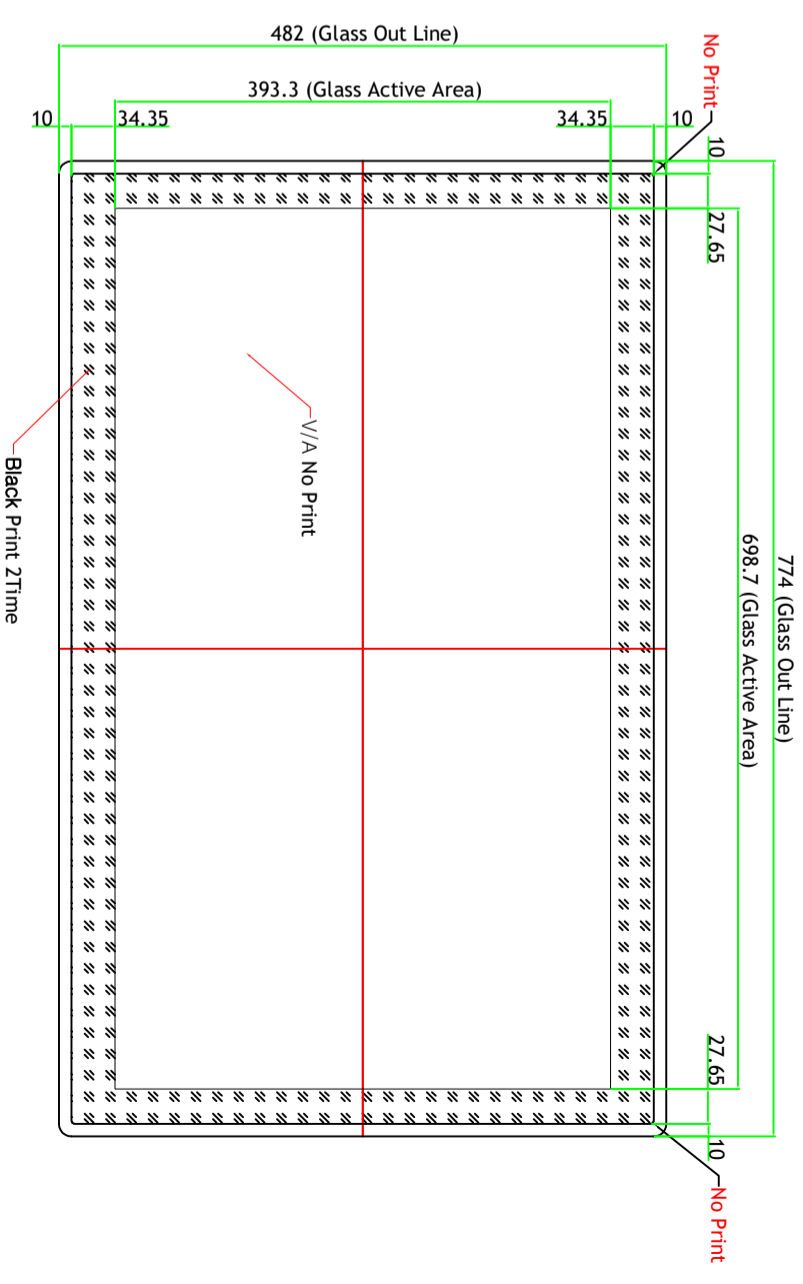

- Black Masking : 2time

### PGLSHT3203002 32.0" Edge-Lit Model Glass Drawing

		MODEL NO	150DLG3206		VIEW :	UNIT : mm	
		NAME	32" Closed Frame		Qty	1	REV.
DRAWN	CHECKED	APPROVED	DWG. NO	4M3203042-00	SCALE	1 / 1	
H.I.Woo		H.Y.Sohn	MATERIAL / FINISH	EGI T=1.2	DATE	2019.09.02	