

Rev	AMEND	DATE	CHECK	APPR.
P1	Proto	2019.09.02	H.I.Woo	H.Y.Sohn
P2				
P3				

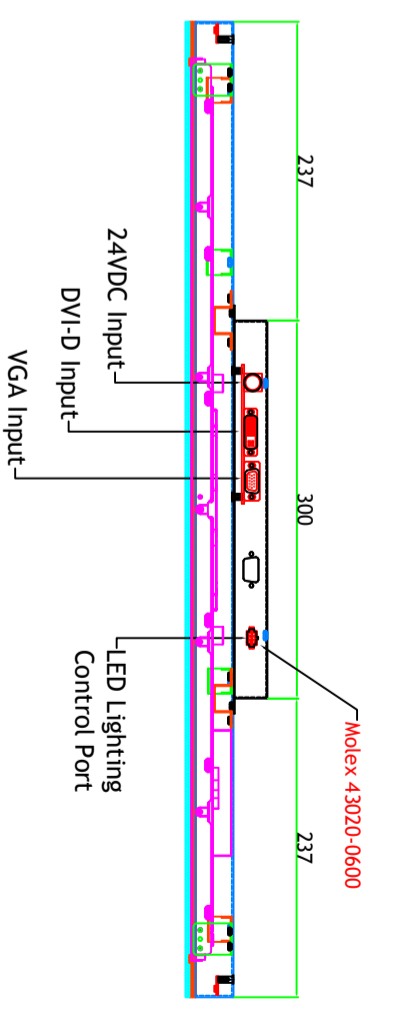

**LED Lighting Control Port Pin Map (w/o IC)**  
 #1 : Red, #2 : Green, #3 : Blue  
 #4 : VCC 12V, #5 : GND, #6 NC

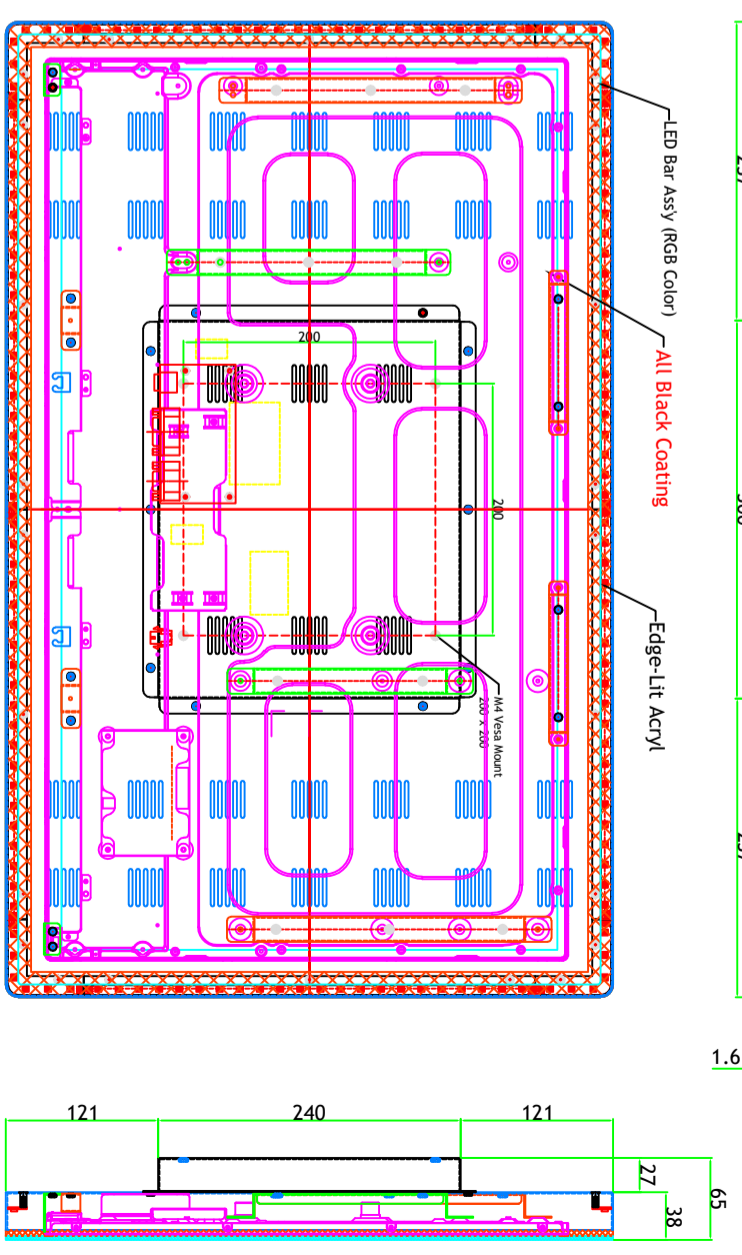
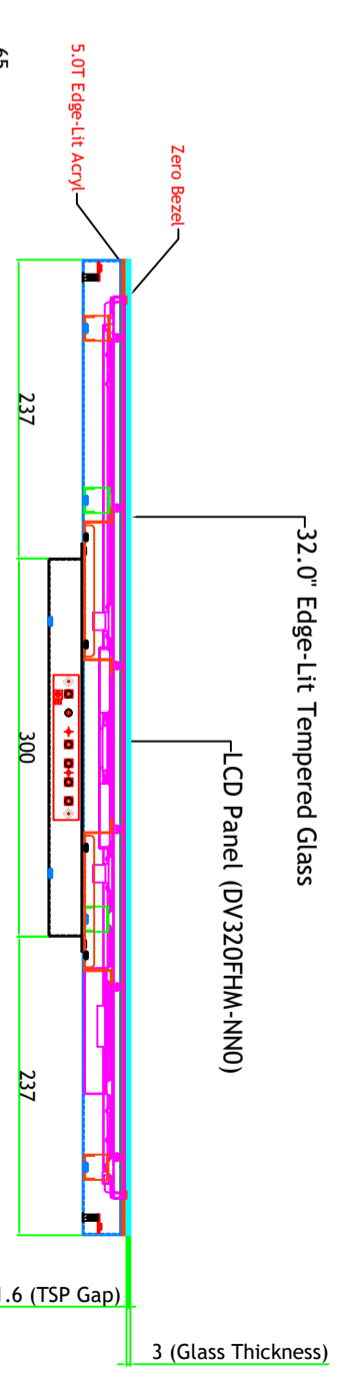
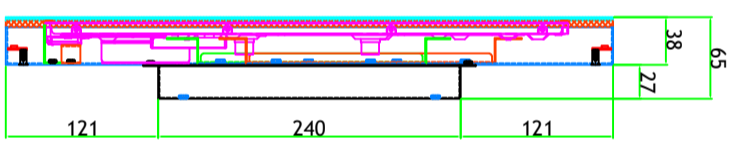
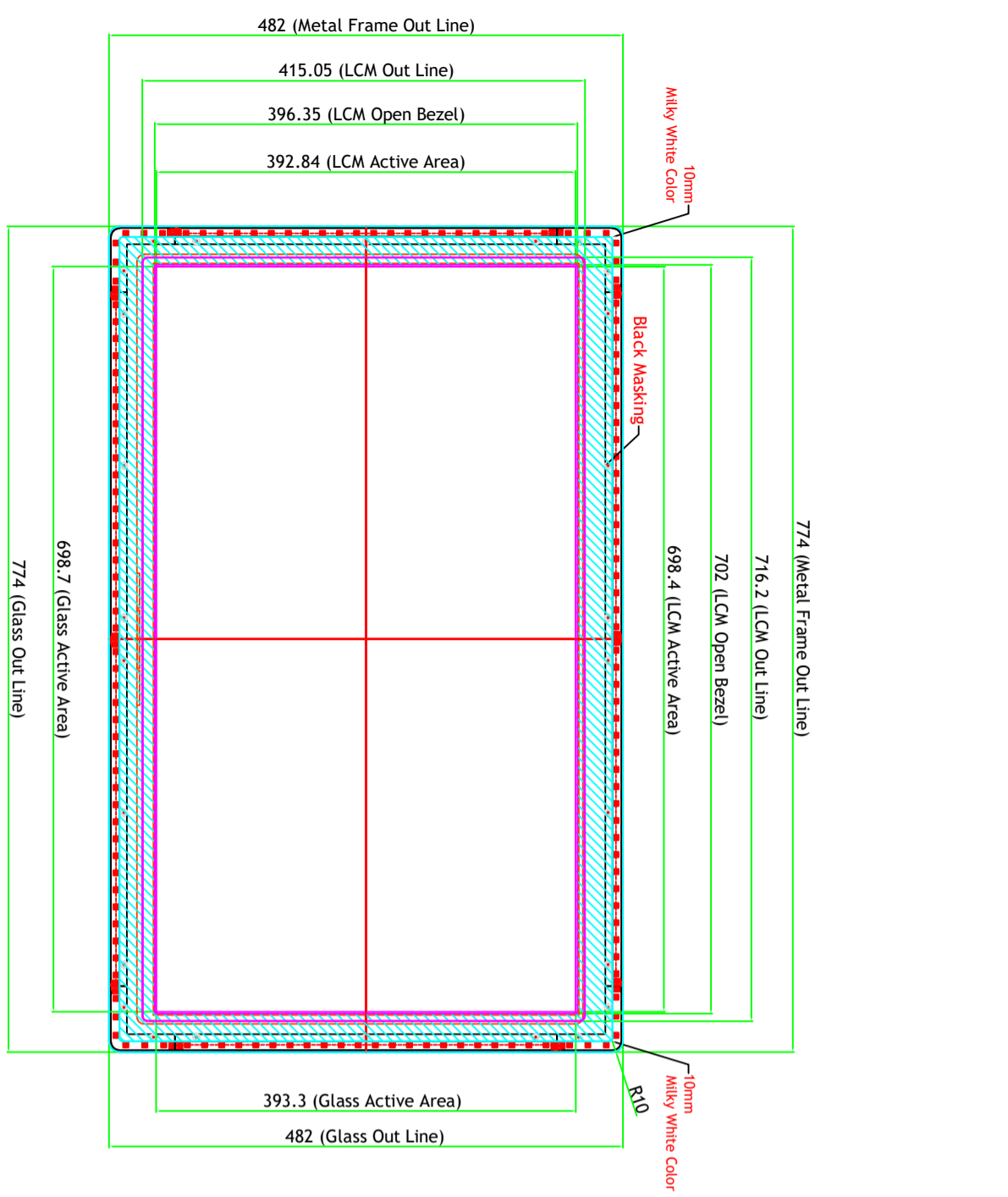
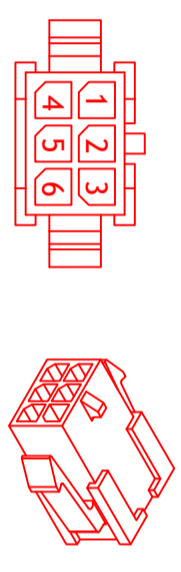

Molex 43020-0600

Main Frame GI = 1.2T Black Coating  
 Rear Cover GI = 1.0T Black Coating

SUZOHAPP		MODEL NO	150DLG3205	VIEW	UNIT : mm
NAME	32" Closed Frame	QTY	1	REV.	P1
DRAWN	CHECKED	APPROVED	DWG. NO	SCALE	1 / 1
H.I.Woo	H.Y.Sohn		4M3203042-00	DATE	2019.09.02
MATERIAL / FINISH		EGI T=1.2			

Rev	AMEND	DATE	CHECK	APPR.
P1	Proto	2019.09.02	H.I.Woo	H.Y.Sohn
P2				
P3				

### Front View

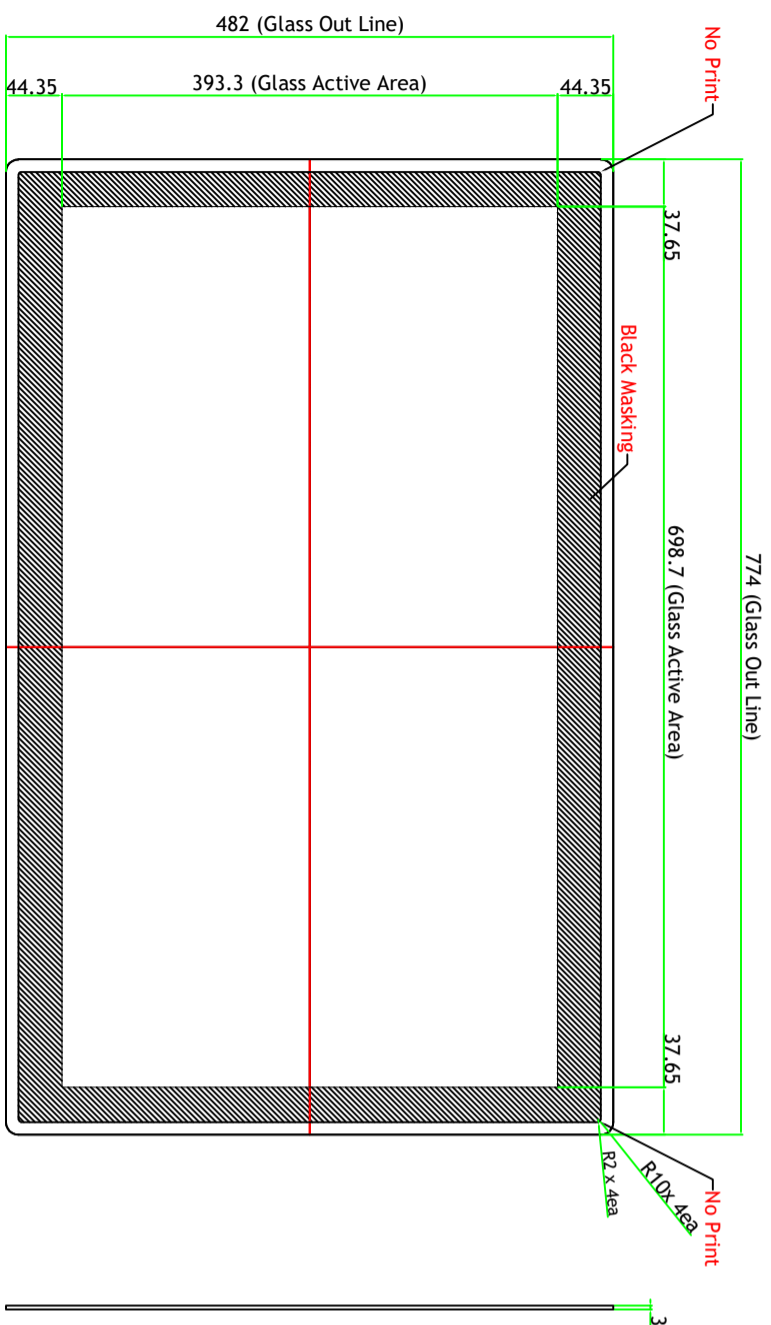

### Rear View

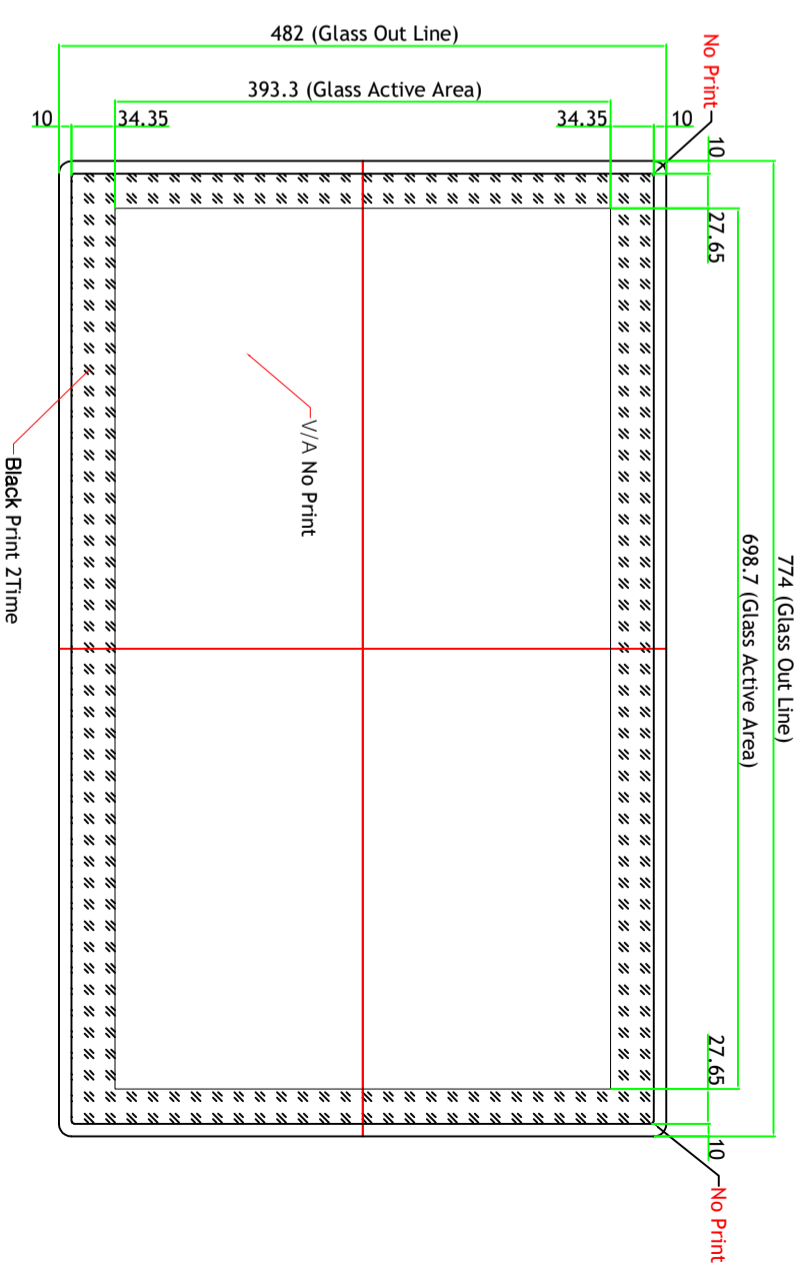

- Black Masking : 2time

PGLSHT3203002 32.0" Edge-Lit Model Glass Drawing

		MODEL NO	150DLG3205	VIEW :	UNIT : mm
		NAME	32" Closed Frame	Qty	1
DRAWN	CHECKED	APPROVED	DWG. NO	SCALE	DATE
H.I.Woo		H.Y.Sohn	4M3203042-00	1 / 1	2019.09.02
		MATERIAL / FINISH	EGI T=1.2		