coinCO[®]

Vantage

Canadian Bill Acceptor







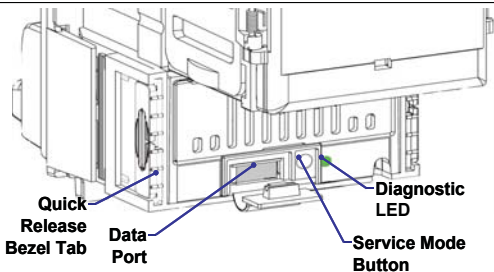
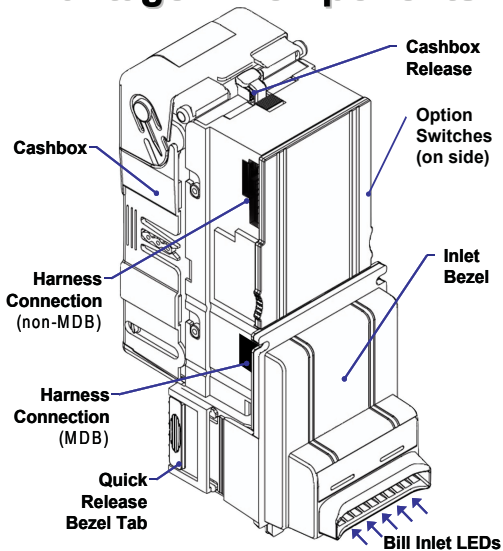

Quick Start Guide



Vantage™ Components



Diagnostic Flash Codes

	Flash Code	Validator Status
Operational	 (solid)	Sales Mode / OK
	 x 1	Coupon Teach
	 x 2	Service Mode
Warning	 x 1	Clean Unit
	 x 2	Service Unit
Out of Service	 x 1	Cashbox Full
	 x 2	Clear Bill Path
	 x 3	Out of Service

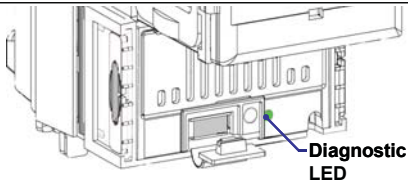

Configuration Settings

ON

Inlet LED On:
Option Enabled

OFF

Inlet LED Off:
Option Disabled

Page 1

Bill Acceptance



\$5 \$10 \$20 \$50 Page 1
(Flash x1)

Page 2

Coupons / Security / Bezel Lights



Coupons High Impulse Smart Page 2
Security Bezel™ (Flash x2)

Page 3

Bill Acceptance / Orientation



1-Way 2-Way Page 3
← → 100 (Flash x3)
4-Way (both)





Page 4

Level 3 Security





Level 3 ← Reserved → Page 4
Security (Flash x4)

To Configure Options

#	Action	Mode	Diagnostic Light
1.	 Press and release button, Diagnostic LED flashes.	Service	 x 2
2.	Remove Lower Housing	Config	
3.	Set Options As Desired (<i>see Options Navigation below</i>)	Config	
4.	Re-install Lower Housing. Inlet LEDs flash 5 times confirming options are saved.	Sales or Ready	
5.	Test Unit to Ensure Proper Setup.		

Options Navigation

 Press once	Scrolls to next set of options within current Page.
 Hold for next Page	Scrolls to next Page of options.

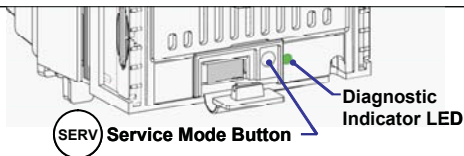



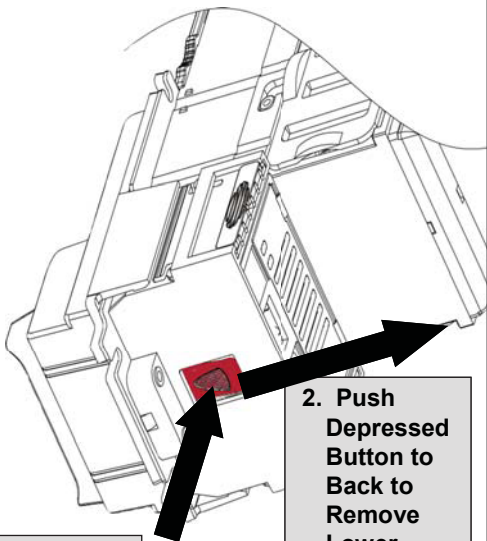







Lower Housing Removal



**1. Depress
Button
Firmly to
Release**

**2. Push
Depressed
Button to
Back to
Remove
Lower
Housing.**

Add / Remove Coupons

#	Action	Mode	Diagnostic Light	Bill Inlet LEDs
1.	 Hold button until Diagnostic LED flashes.	Coupon Teach	 (flash)	 (flash)
2.	Insert Coupon to be Added <u>or</u> Removed.			
ADD Coupon				
3a.	Coupon accepted and returned.	Coupon Teach	 (fast rate)	 (fast rate)
4a.	Automatically returns to Sales Mode. Coupon <u>addition</u> complete.	Sales	 (solid)	 (cycle)
REMOVE Coupon				
3b.	Coupon disabled and returned.	Coupon Teach	 (fast rate)	 (fast rate)
4b.	Automatically returns to Sales Mode. Coupon <u>removal</u> complete.	Sales	 (solid)	 (cycle)
Coupon <i>NOT</i> Recognized				
3c.	Coupon returned. Inlet LEDs flash at original rate.	Coupon Teach	 (flash)	 (flash)
4c.	Insert another coupon (see Step 2 above) OR  Hold button to return to Sales Mode (note unit returns automatically after 40 secs of inactivity).			

Option / Dip Switch Settings

Note: There are no switches on MDB only models.

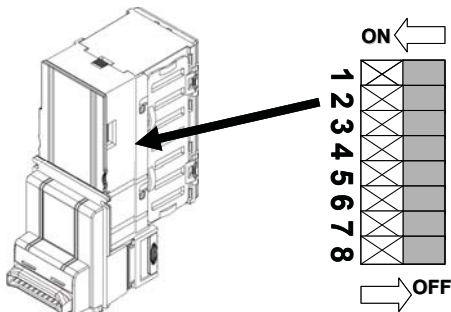

Pulse Timing	Switch 1	Switch 2
50 / 50mS	ON	ON
150 / 150mS	ON	OFF
Custom	OFF	ON
Parallel (Credit Line)	OFF	OFF

	ON	OFF
Switch 3	4 Pulse / \$	1 Pulse / \$
Switch 4	Always Enabled	Host Enabled
Switch 5	Serial	Pulse
Switches 6 - 8	<i>Reserved</i>	

Note:

1. "Custom" has a default setting of 200 / 200mS
2. Power must be reset for switch settings to take effect.

Quick Release Bezel Operation

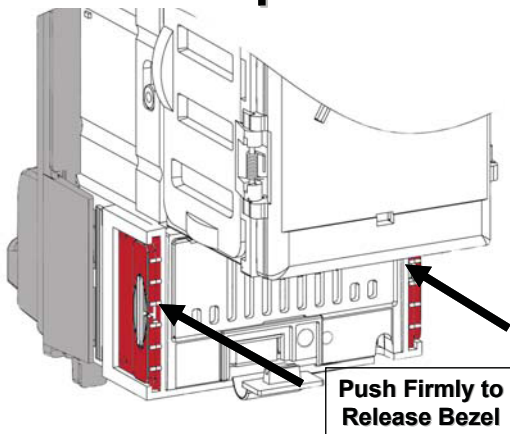

1. Push firmly on Quick Release Tabs using a screwdriver tip. Tabs will move towards bezel and latch.
2. Once both tabs are latched, the bill acceptor will separate from the bezel.
3. To reattach, push bill acceptor body firmly onto bezel until it locks.

Smart Bezel™

Communicates to Customer Which Bills Are Accepted

Feature not available on all models.

Denotes acceptance of both \$5 and \$10 bills.

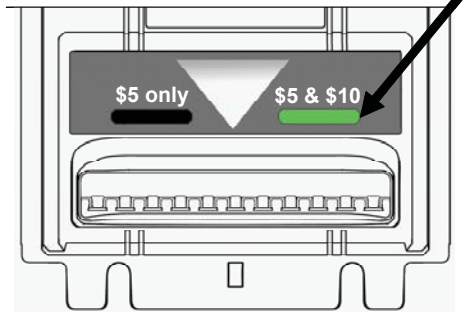

- **\$5 & \$10 Is Lit When:** Both bills accepted and change can be made for them.
- **\$5 Only Is Lit When:** Change can only be made for \$5 bills.

Note: For correct operation, make sure \$5 and \$10 bills are enabled (see Configuration Settings).

For more information on the Vantage™, please see the Operation and Service Manual, available at www.coinco.com

Notes

**For technical support on this or any
other Coinco product,
contact your nearest Coinco
Office/ServiceCenter.**

**email: techsupport@coinco.com
www.coinco.com**

Coinco Publication # 929027

 SUZOHAPP